

[54] BOW GUIDE

[76] Inventor: Rick Concoff, P.O. Box 1428, Middletown, Calif. 95461

[**] Term: 14 Years

[21] Appl. No.: 230,987

[22] Filed: Aug. 11, 1988

[52] U.S. Cl. D17/20; 84/283

[58] Field of Search D17/14, 17, 20; 84/281-283, 453, 465; D8/70, 71, 72; 24/17 B, 265 AL, 482

[56] References Cited

U.S. PATENT DOCUMENTS

D. 305,860	2/1990	DeFrance	D8/14
2,782,670	2/1957	Lipski	84/283
3,914,831	10/1975	Steinberg	24/265 AL
4,222,302	9/1980	Sanfilippo	84/283
4,729,587	3/1988	Ward	294/19.1
4,854,212	8/1989	Levin et al.	84/283

Primary Examiner—Bernard Ansher
Assistant Examiner—Adir Aronovich

[57] CLAIM

The ornamental design for a bow guide, as shown and described.

DESCRIPTION

FIG. 1 is a front, top perspective view in an assembled condition of a bow guide, showing my new design; FIG. 2 is an exploded view thereof; FIG. 3 is a top plan view thereof; FIG. 4 is a front elevational view thereof; FIG. 5 is a side elevational view thereof; FIG. 6 is a bottom plan view thereof; and FIG. 7 is a perspective view of a bow guide in an alternate position from FIG. 2.

The looped ring around the bow guide has been omitted in FIGS. 3-7 for ease of illustration.

The broken line showing of a violin is for illustrative purposes only and forms no part of the claimed design.

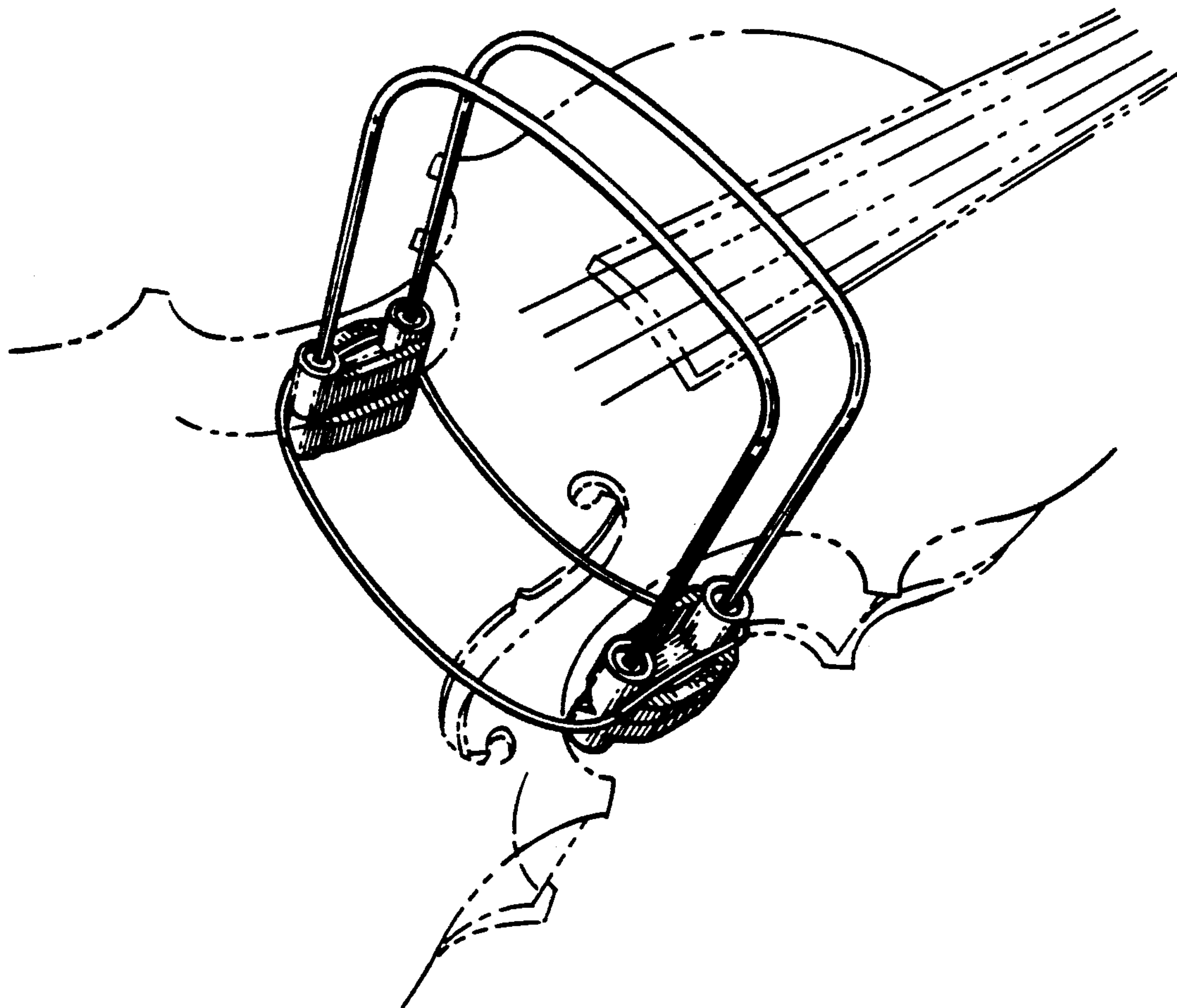

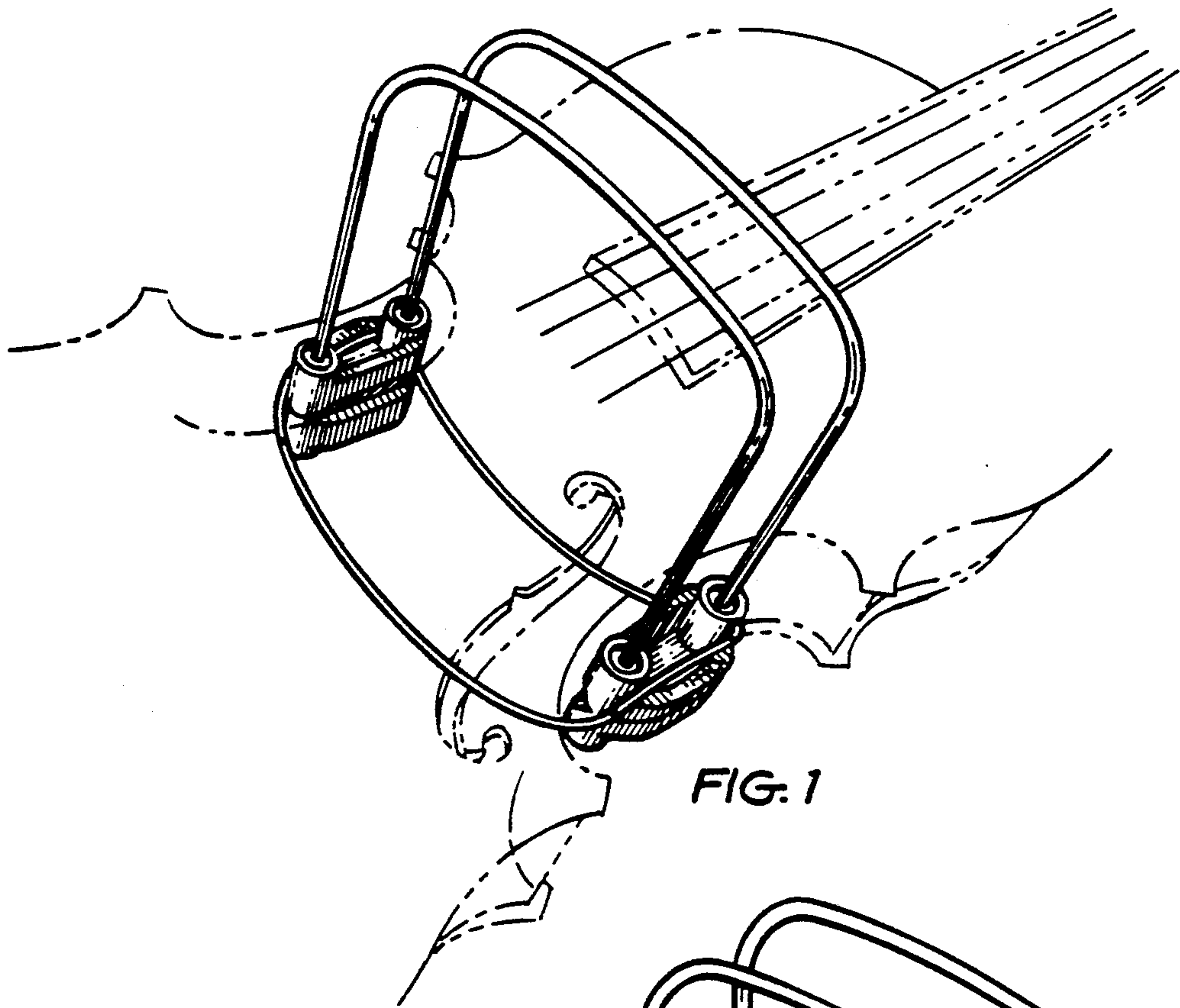

FIG. 1

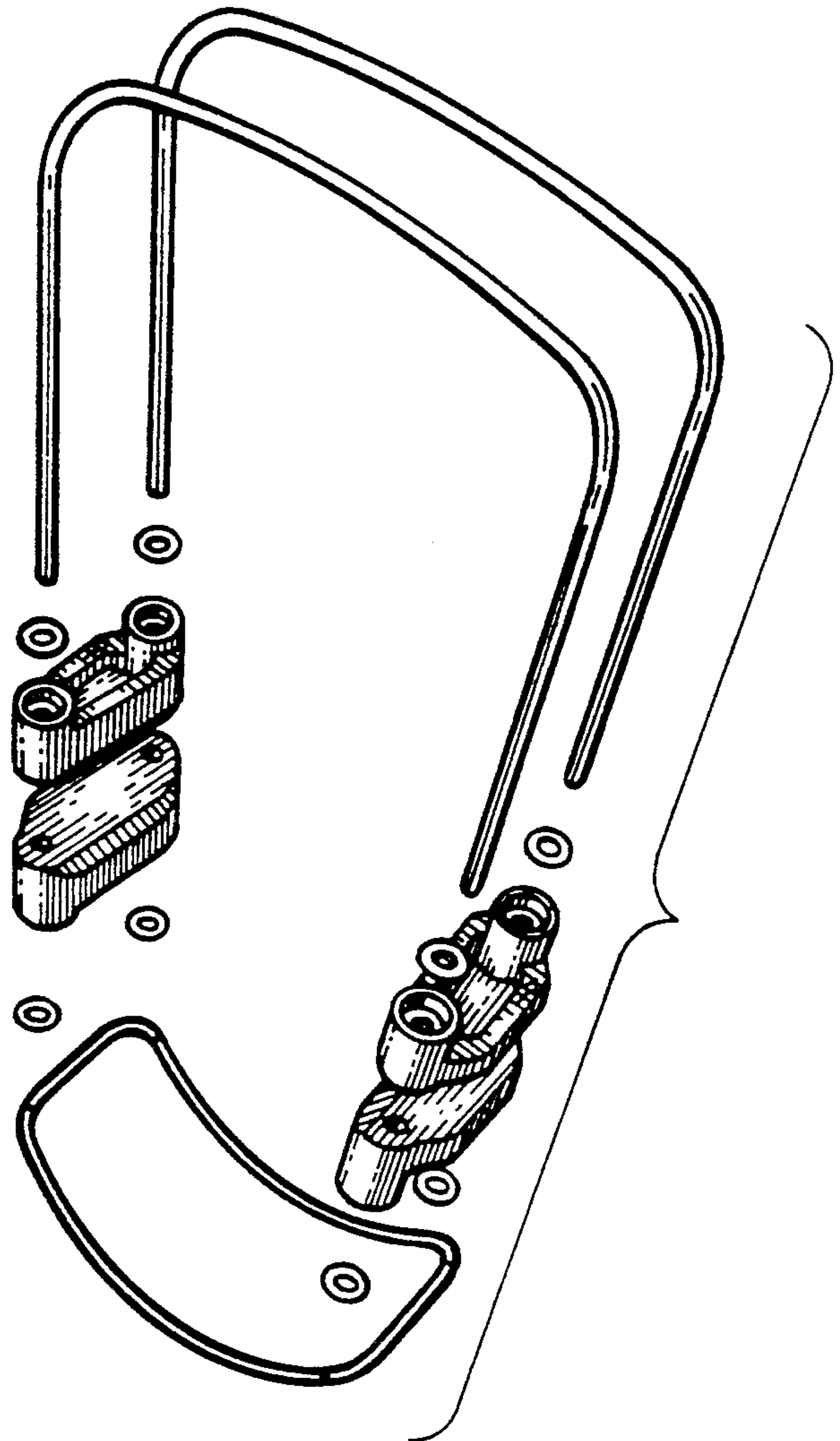

FIG. 2

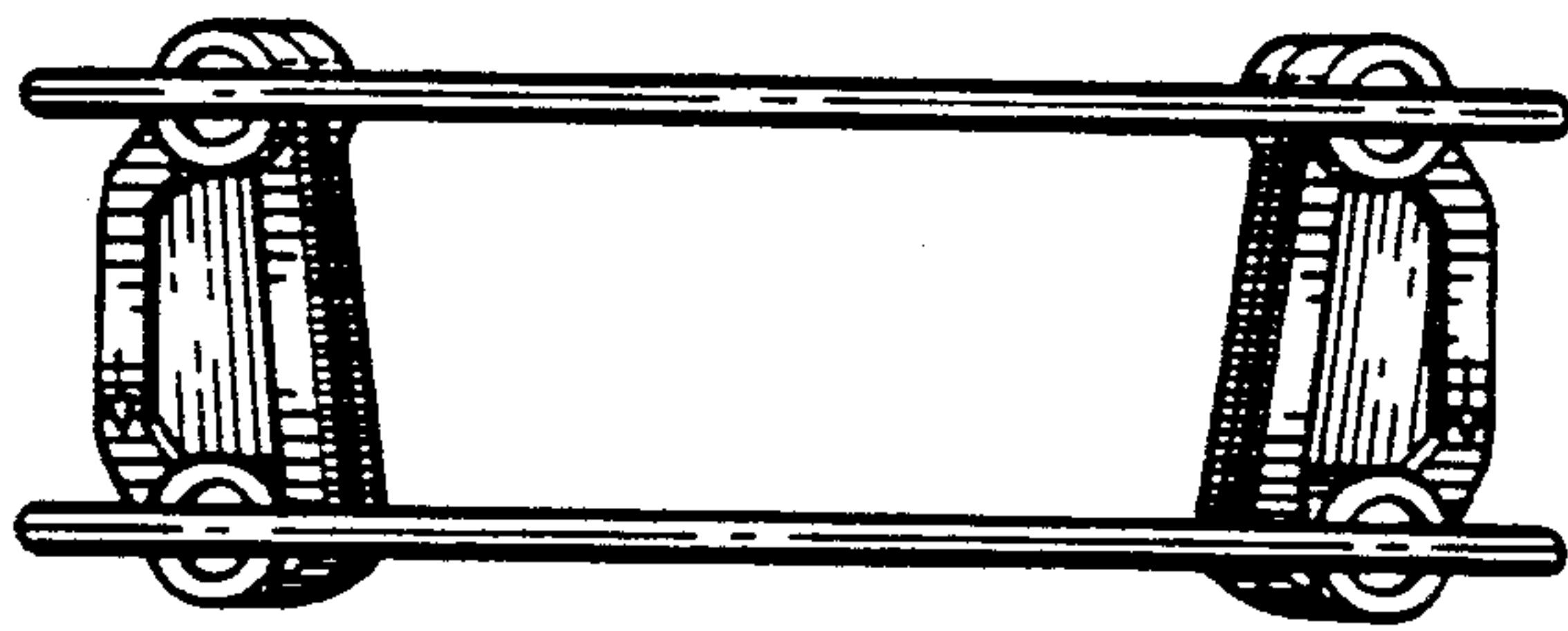

FIG. 3

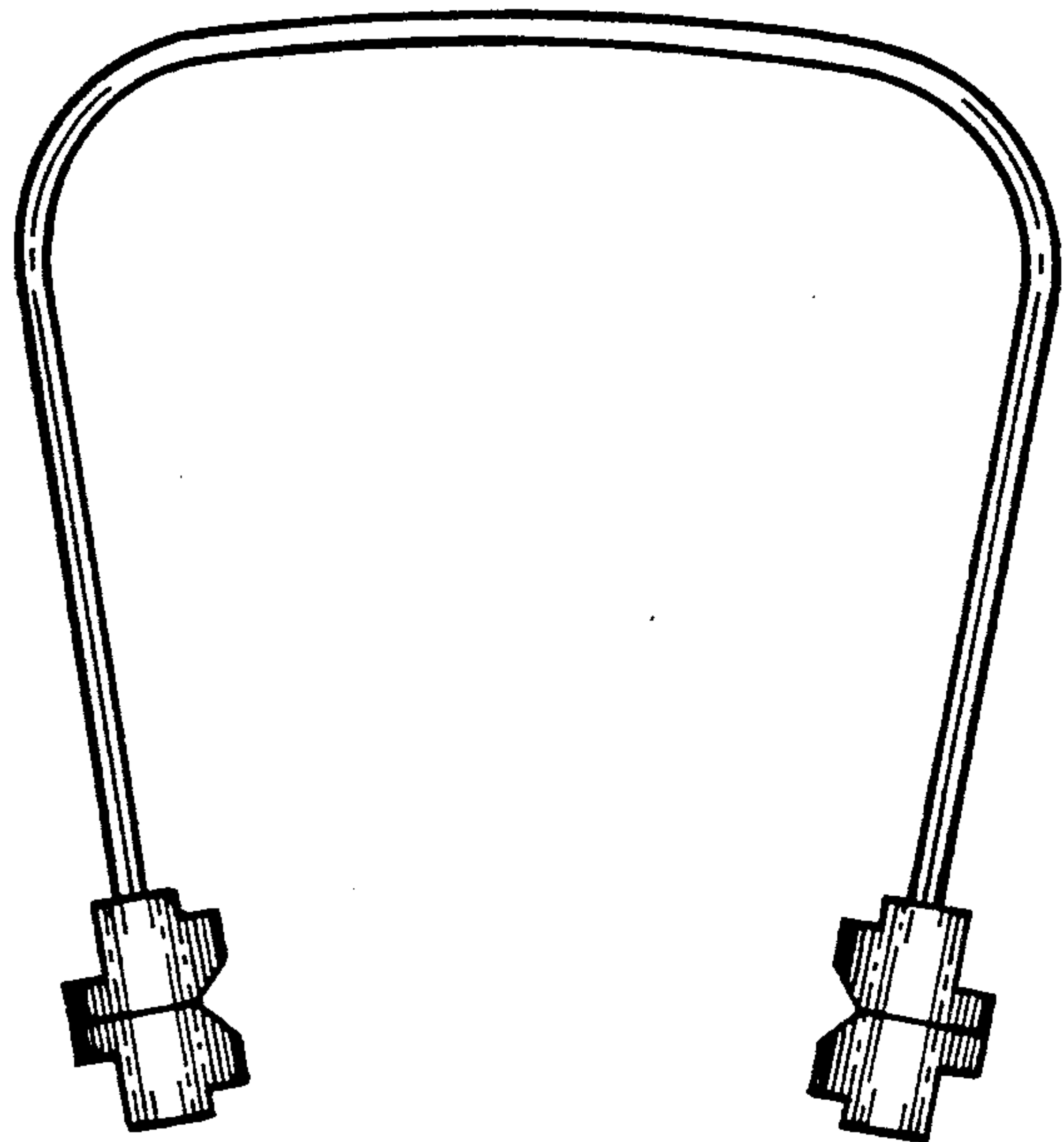

FIG. 4

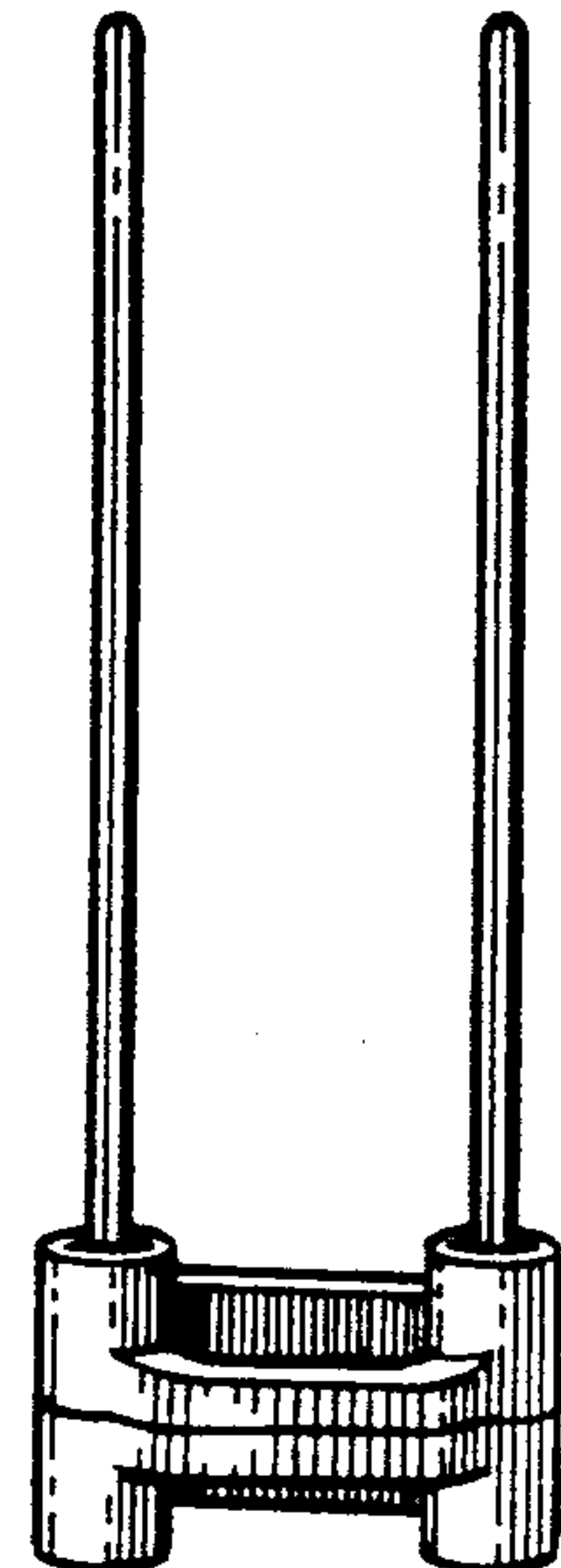

FIG. 5

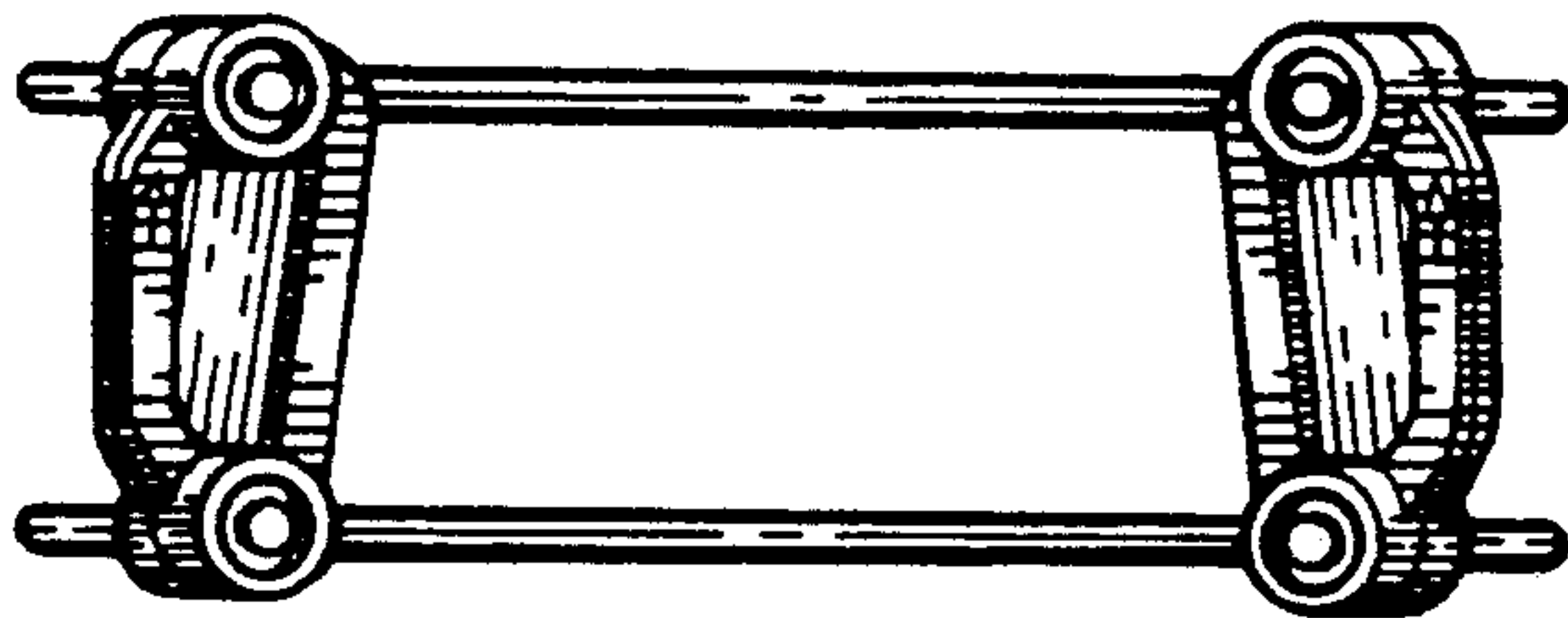

FIG. 6

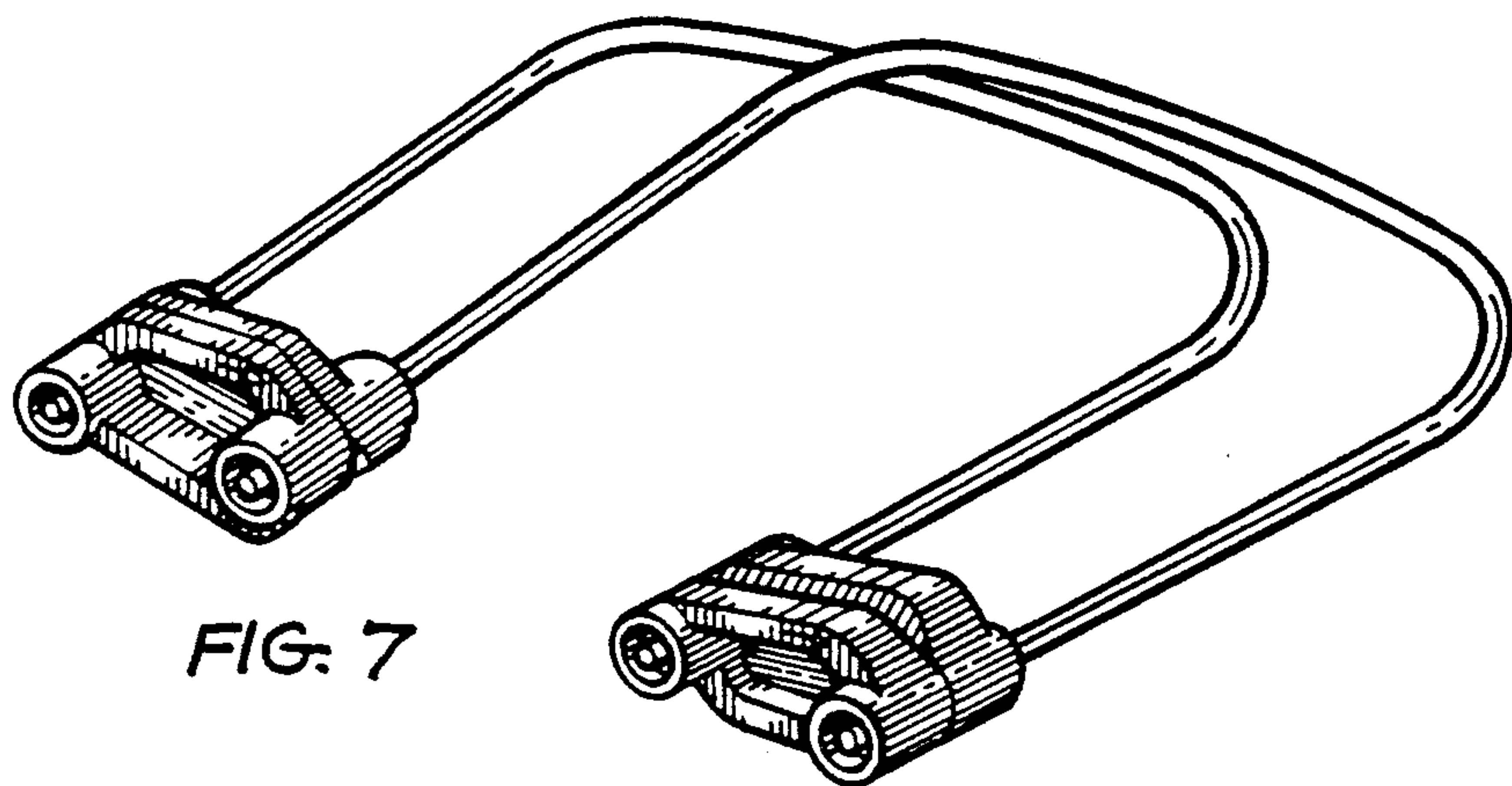

FIG. 7