

[54] **SUN VISOR FOR ATTACHMENT TO AN INFANT'S SEAT**

[76] **Inventor: Juli A. Shuman, 18080 Galehouse Rd., Doylestown, Ohio 44230**

[**] **Term: 14 Years**

[21] **Appl. No.: 262,021**

[22] **Filed: Oct. 25, 1988**

[52] **U.S. Cl. D6/333**

[58] **Field of Search D6/333, 363, 419, 491, D6/500; D8/71, 72, 396**

[56] **References Cited**

U.S. PATENT DOCUMENTS

- D. 250,300 11/1978 Rohr D6/363 X
- D. 261,843 11/1981 Wall D6/500
- D. 266,385 10/1982 Musgrove et al. D6/500
- D. 285,155 8/1986 Allen D6/500

- D. 310,311 9/1990 Berger et al. D6/500
- 2,731,696 1/1956 Sutton D8/72

Primary Examiner—Bruce W. Dunkins
Assistant Examiner—Gary D. Watson
Attorney, Agent, or Firm—Leon Gilden

[57] **CLAIM**

The ornamental design for a sun visor for attachment to an infant's seat, as shown and described.

DESCRIPTION

FIG. 1 is a front elevational view of a sun visor for attachment to an infant's seat showing my new design; FIG. 2 is a rear elevational view thereof; FIG. 3 is a left side elevational view thereof; FIG. 4 is a right side elevational view thereof; FIG. 5 is a top plan view thereof; FIG. 6 is a bottom plan view thereof; and FIG. 7 is a perspective view thereof on an enlarged scale.

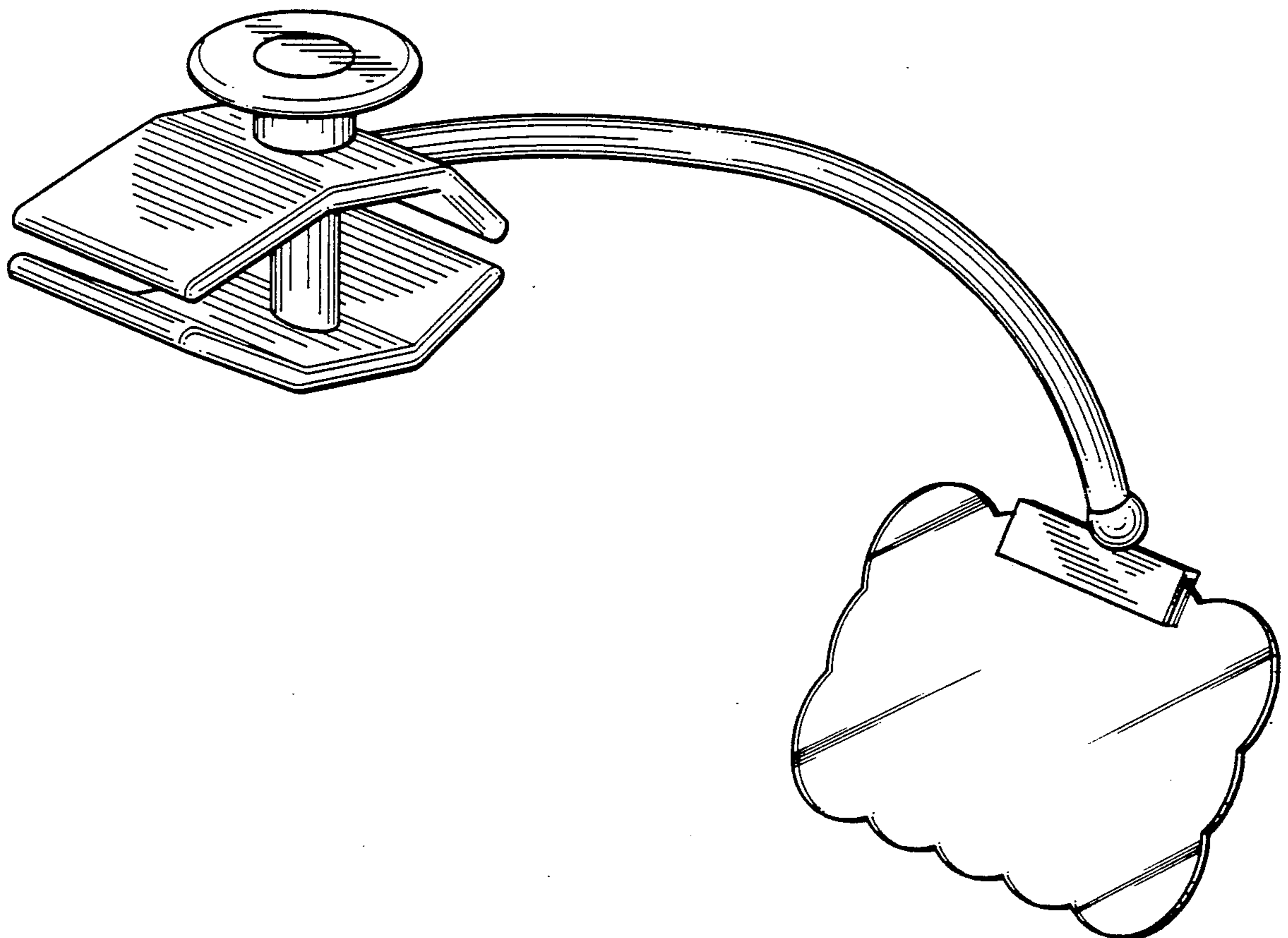

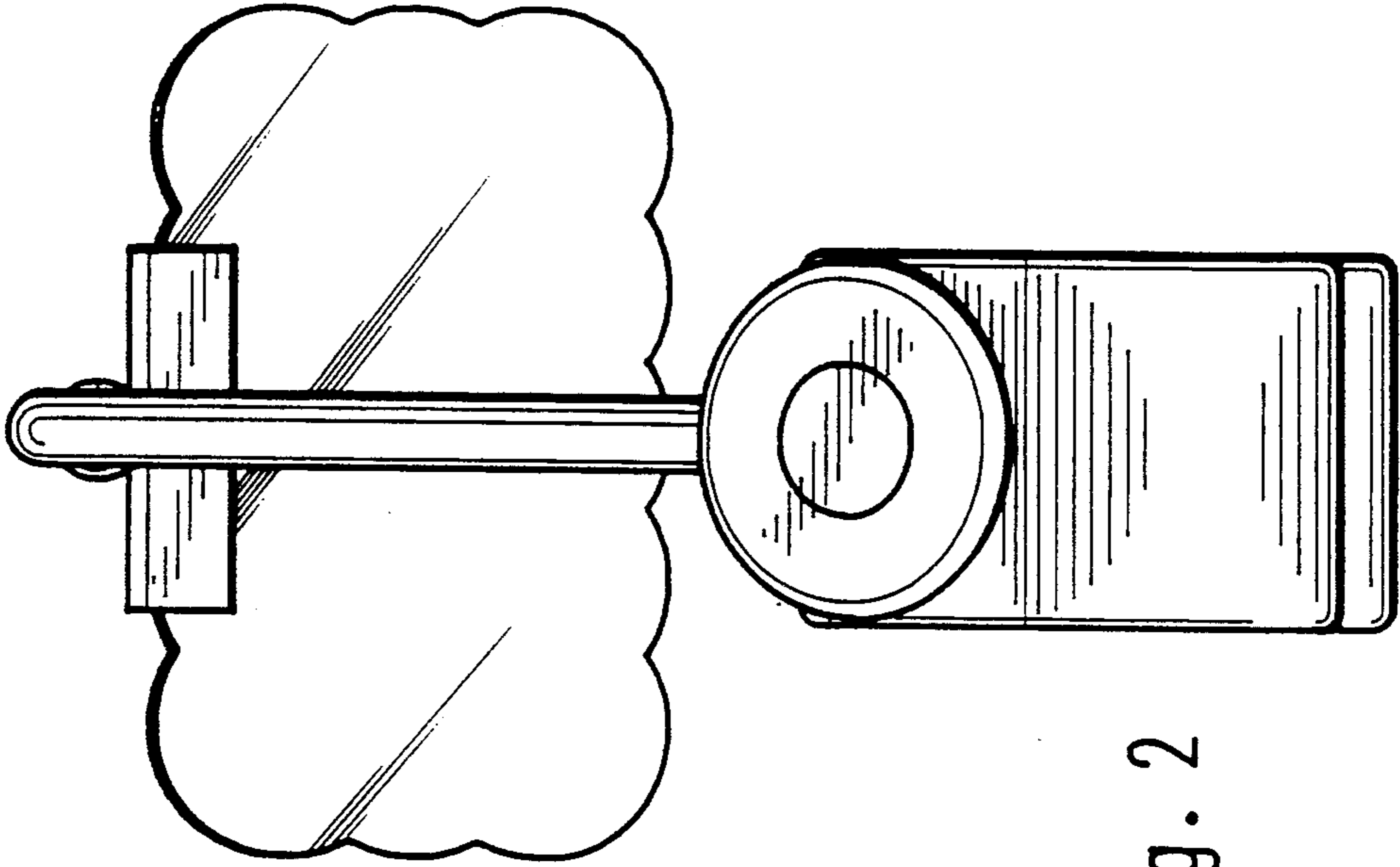

Fig. 2

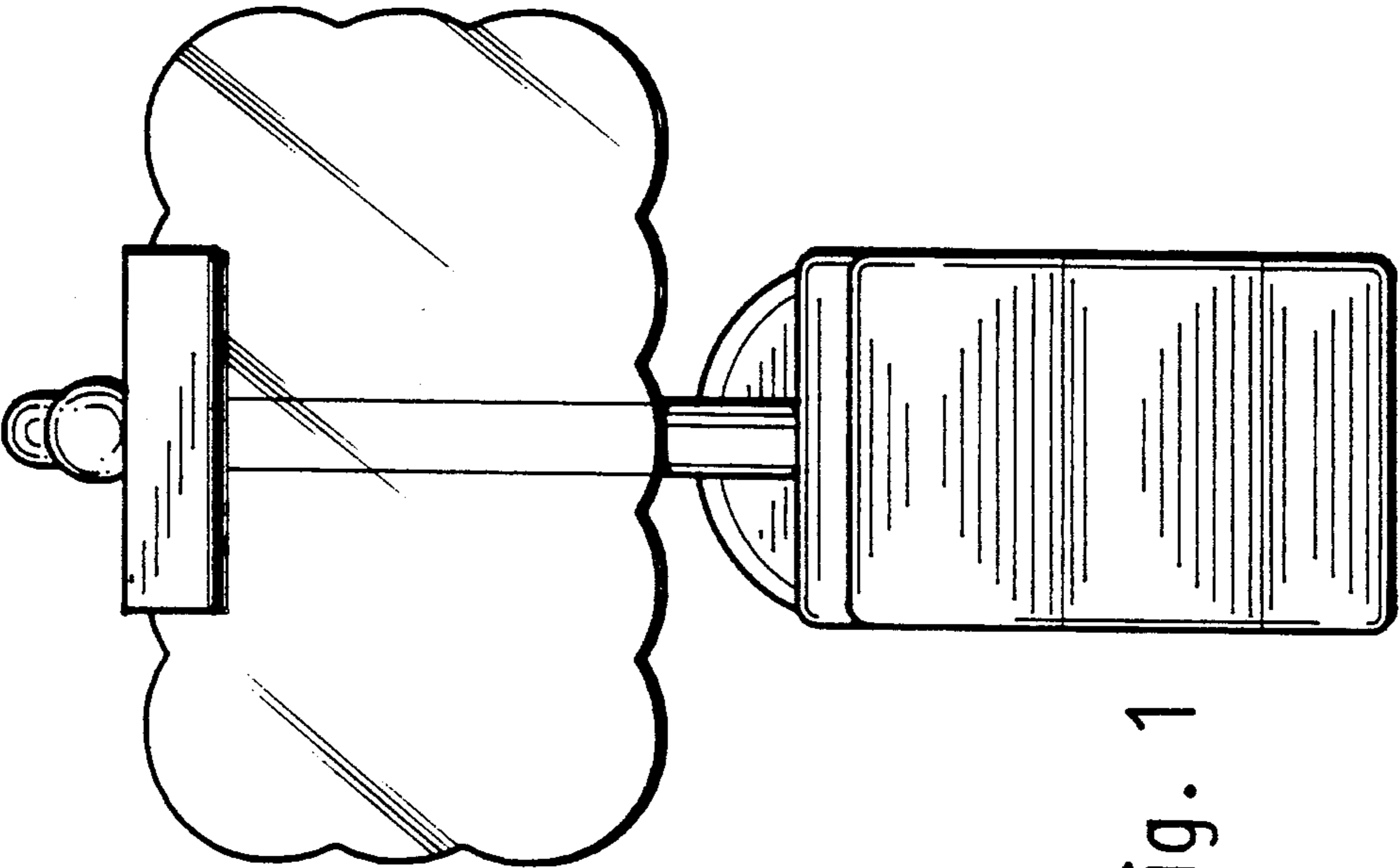

Fig. 1

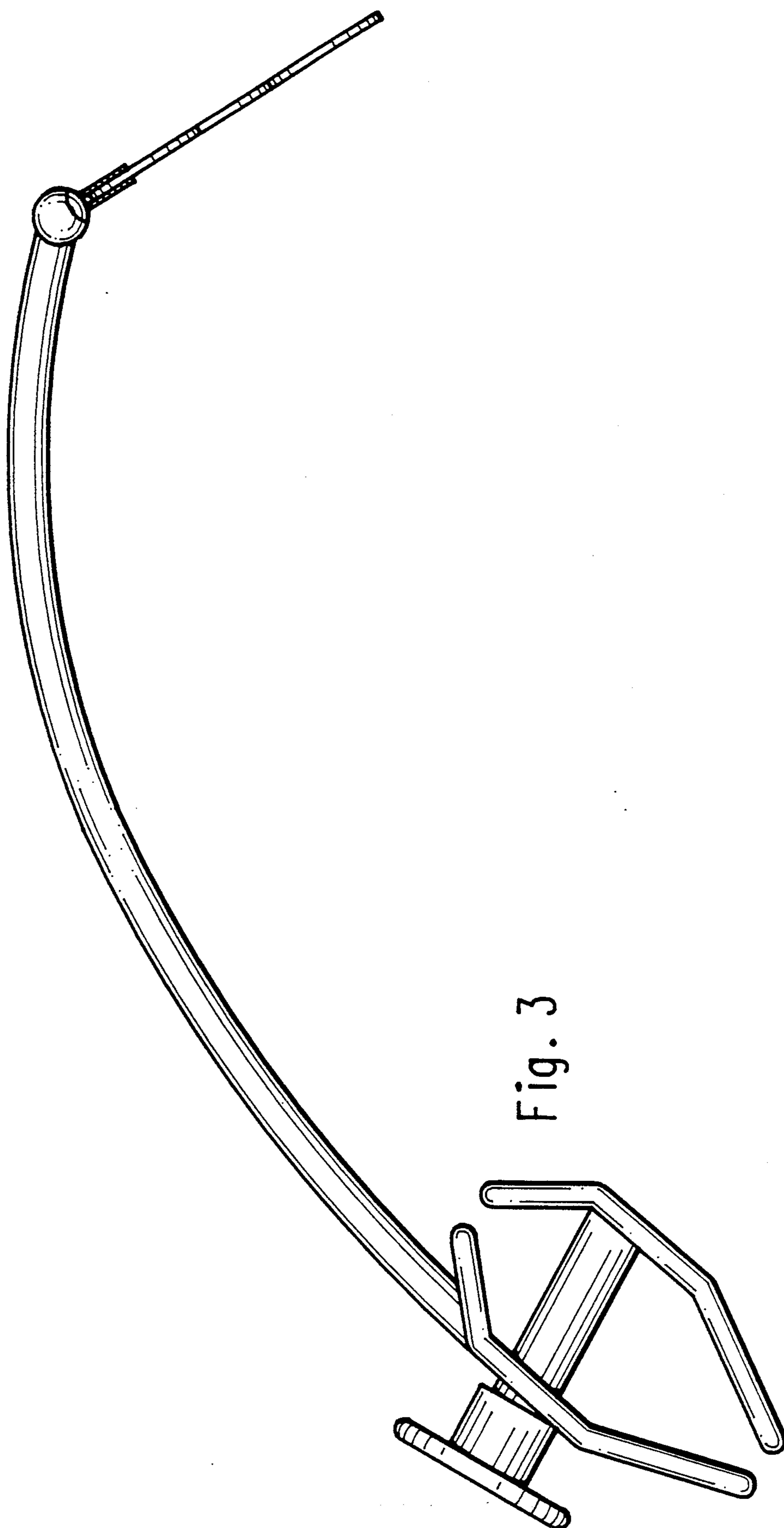

Fig. 3

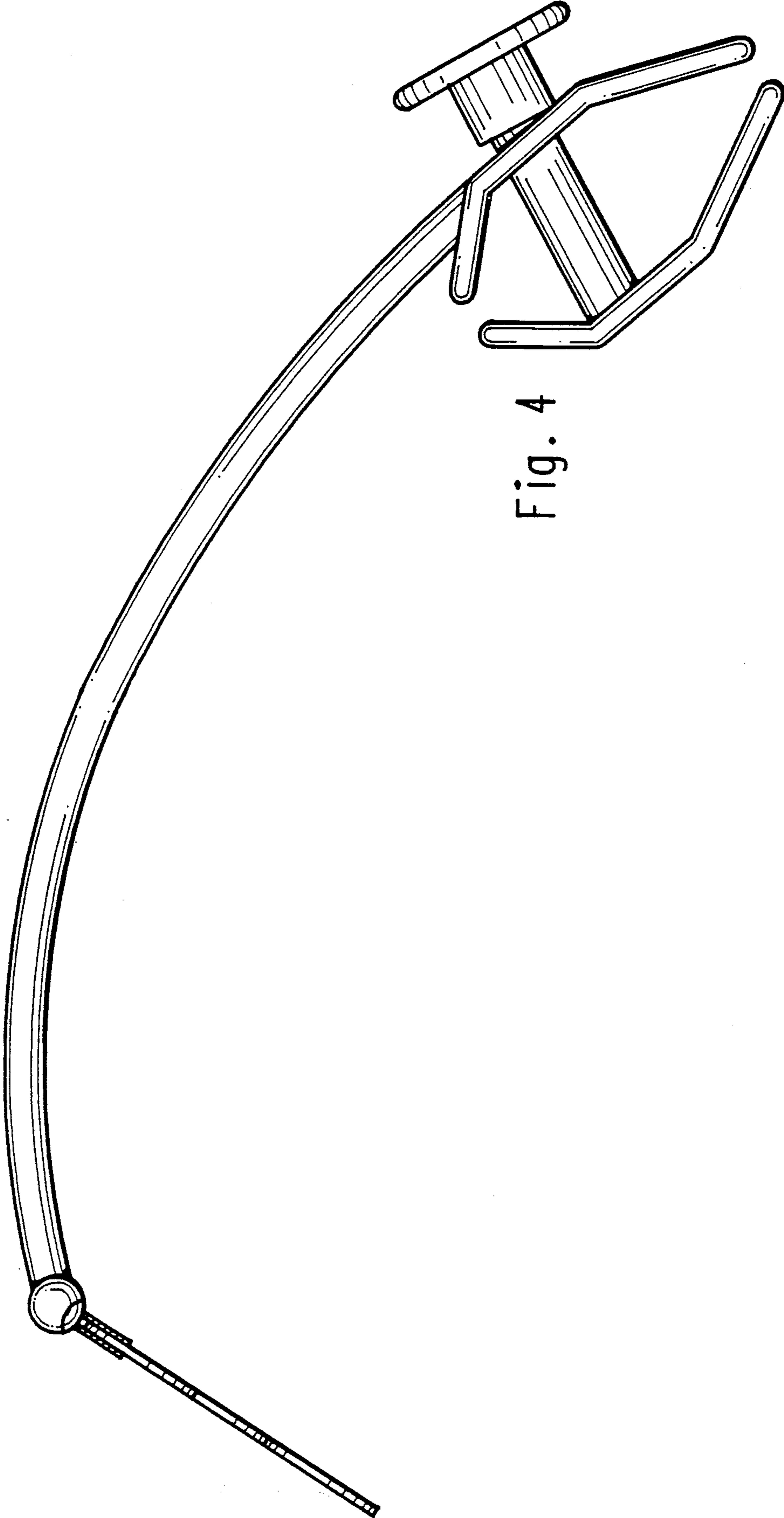

Fig. 4

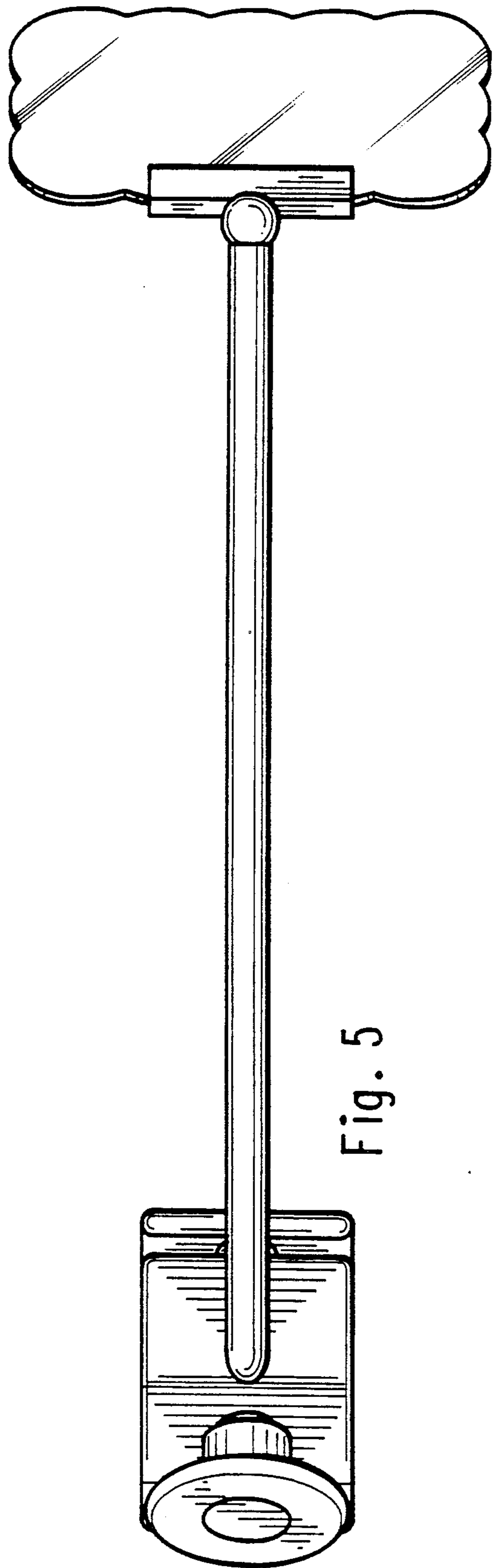

Fig. 5

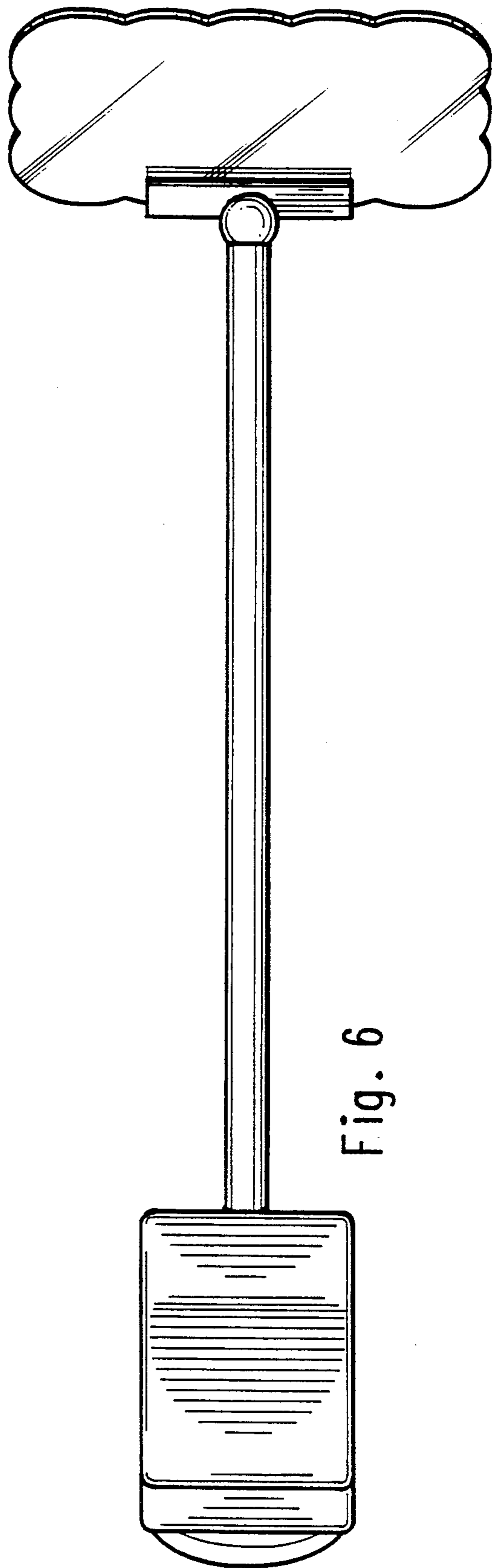

Fig. 6

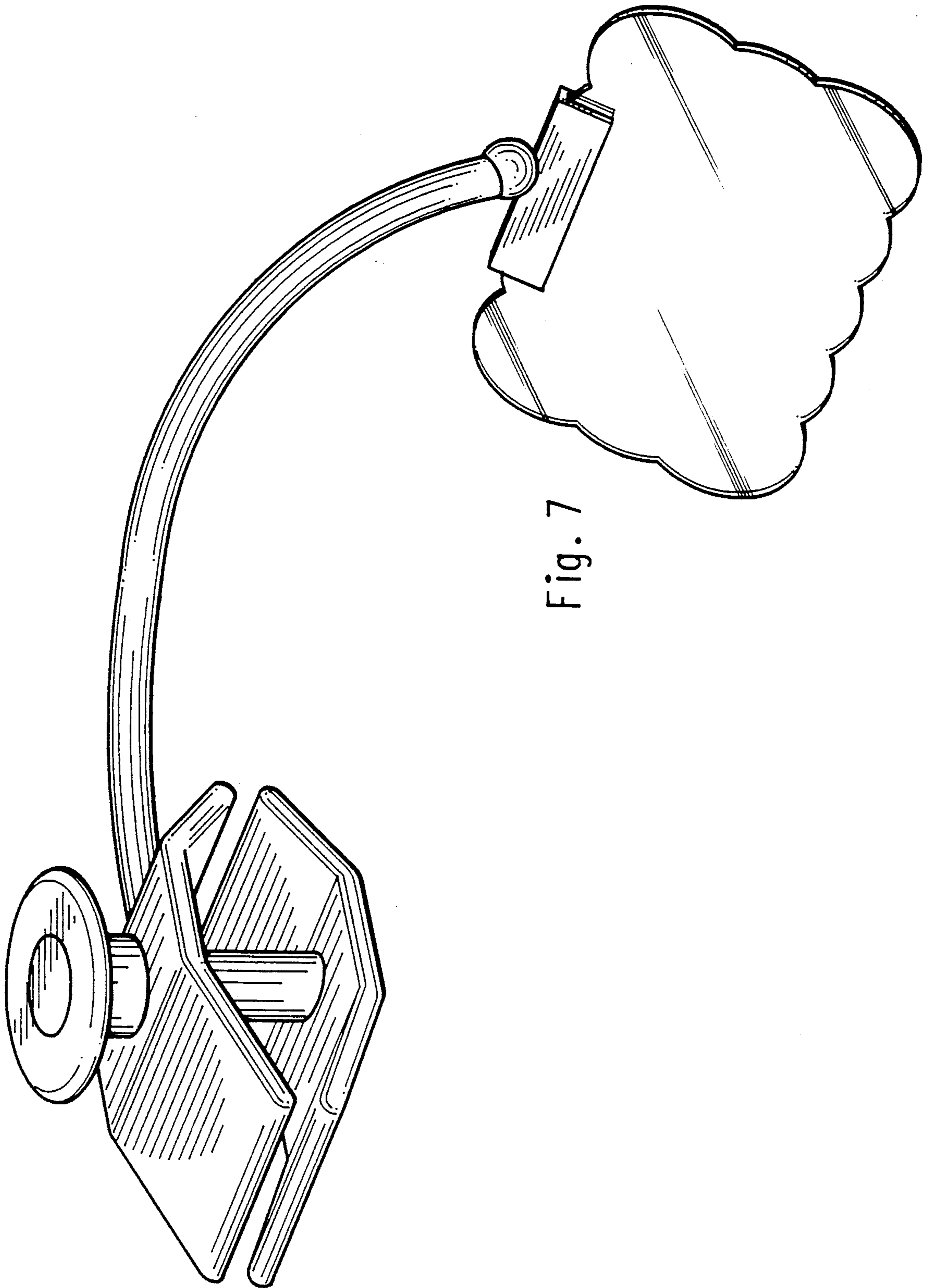

Fig. 7