

[54] **NET SUPPORT**

[76] **Inventor: Gary K. Sephton, 690 Island Way,
#906, Clearwater, Fla. 34630**

[**] **Term: 14 Years**

[21] **Appl. No.: 454,127**

[22] **Filed: Dec. 21, 1989**

[52] **U.S. Cl. D21/201**

[58] **Field of Search D21/200, 201;
273/1.5 R, 1.5 A, 55 D**

[56] **References Cited**

U.S. PATENT DOCUMENTS

4,786,053 11/1988 Barnes, Jr. 273/1.5 R
4,915,381 4/1990 Hackett 273/1.5 A

*Primary Examiner—Terry A. Pfeffer
Attorney, Agent, or Firm—Frijouf, Rust & Pyle*

[57] **CLAIM**

The ornamental design for a net support, as shown and described.

DESCRIPTION

FIG. 1 is a perspective view of a net support showing my new design;
FIG. 2 is a front elevational view thereof;
FIG. 3 is a rear elevational view thereof;
FIG. 4 is a top plan view thereof;
FIG. 5 is a bottom plan view thereof;
FIG. 6 is a right side elevational view thereof; and
FIG. 7 is a left side elevational view thereof.

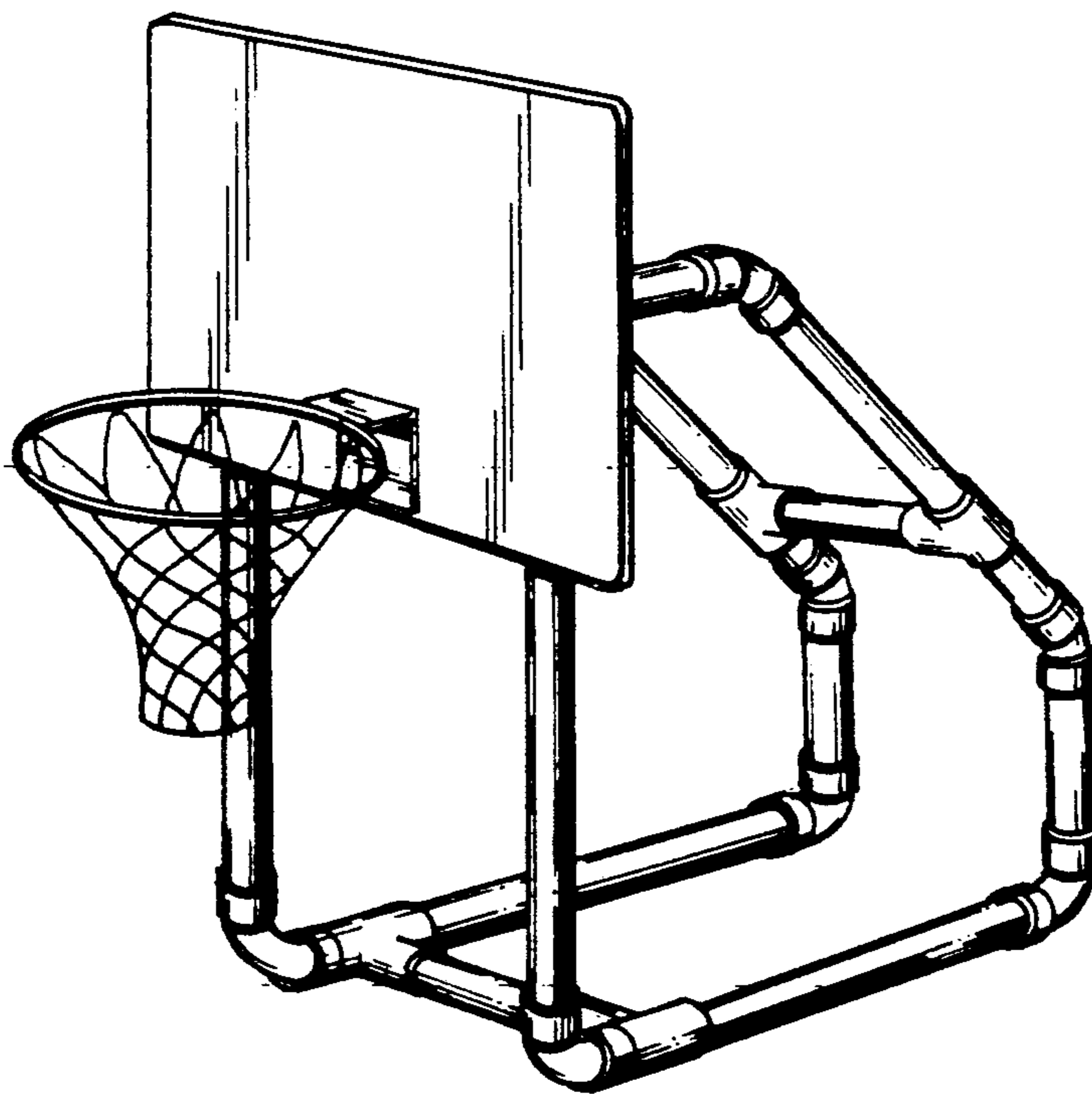

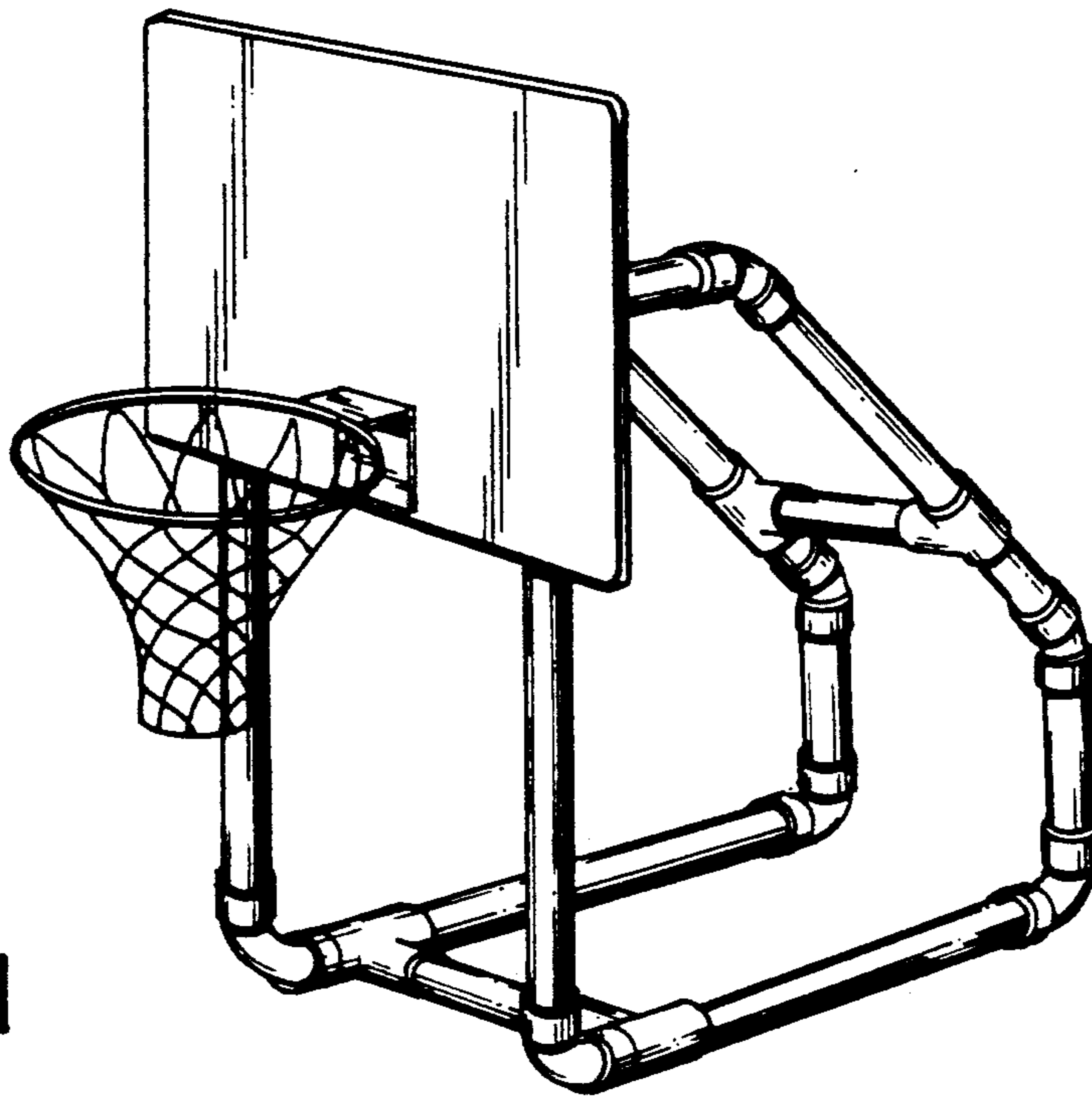

FIG. 1

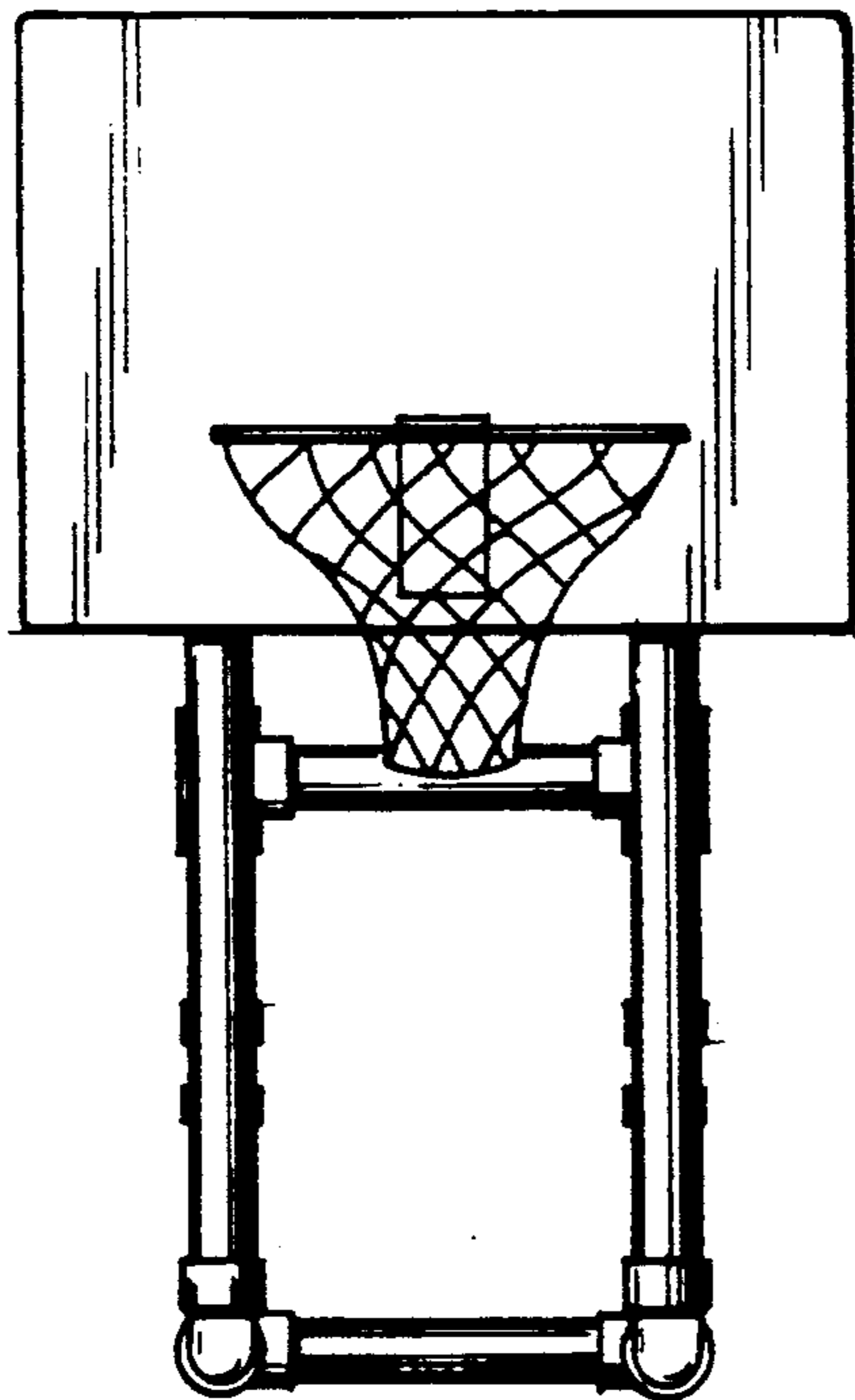

FIG. 2

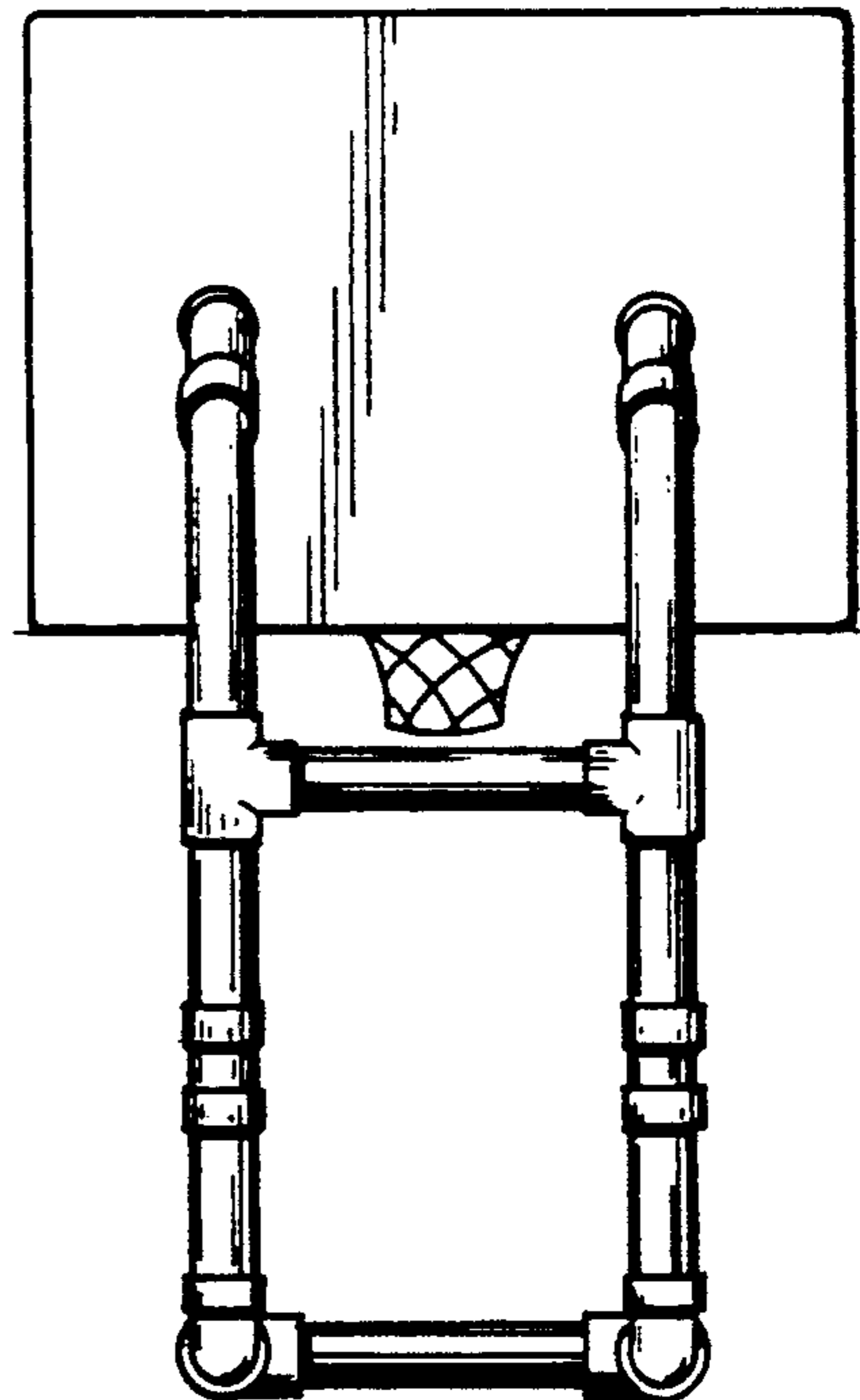

FIG. 3

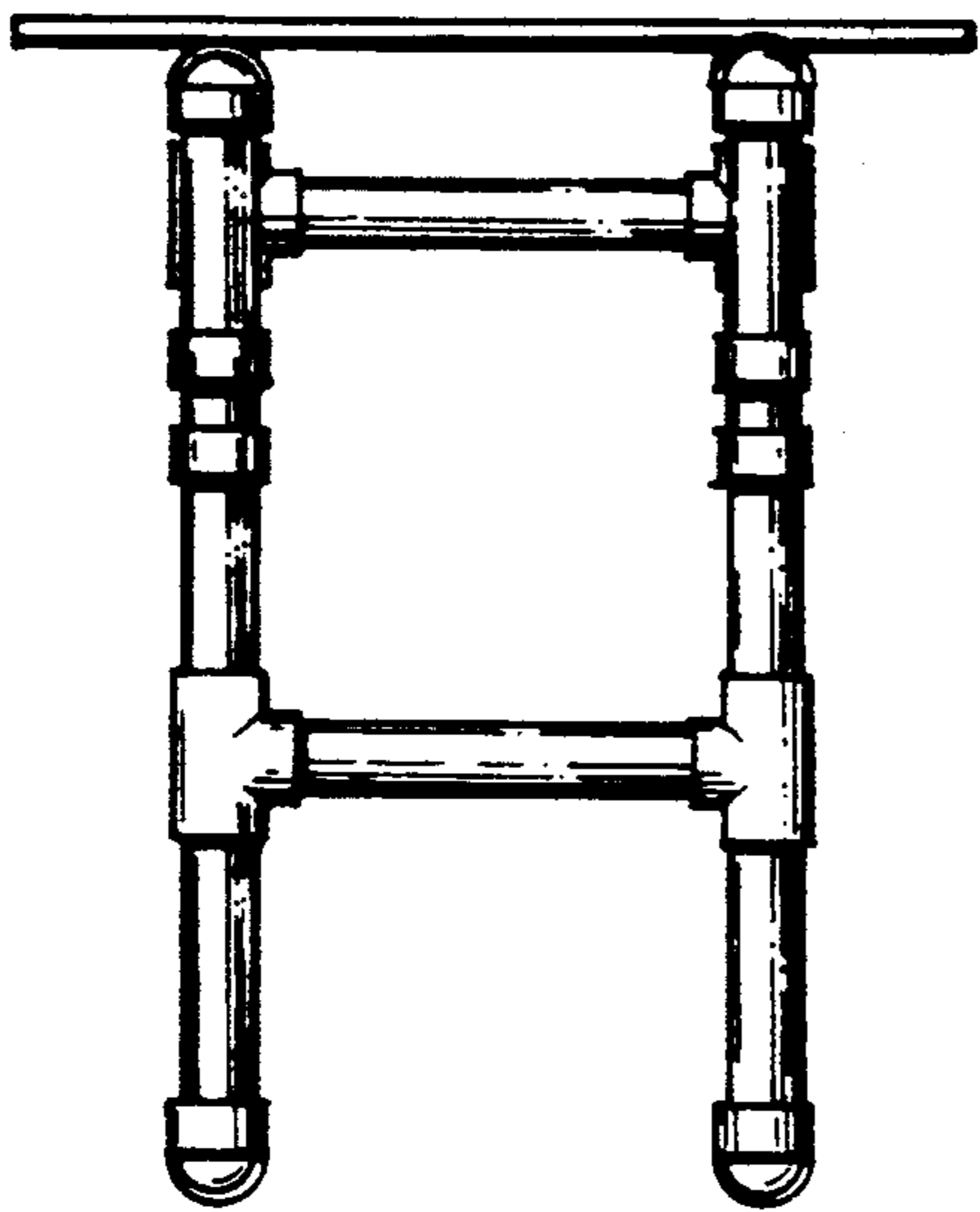

FIG. 4

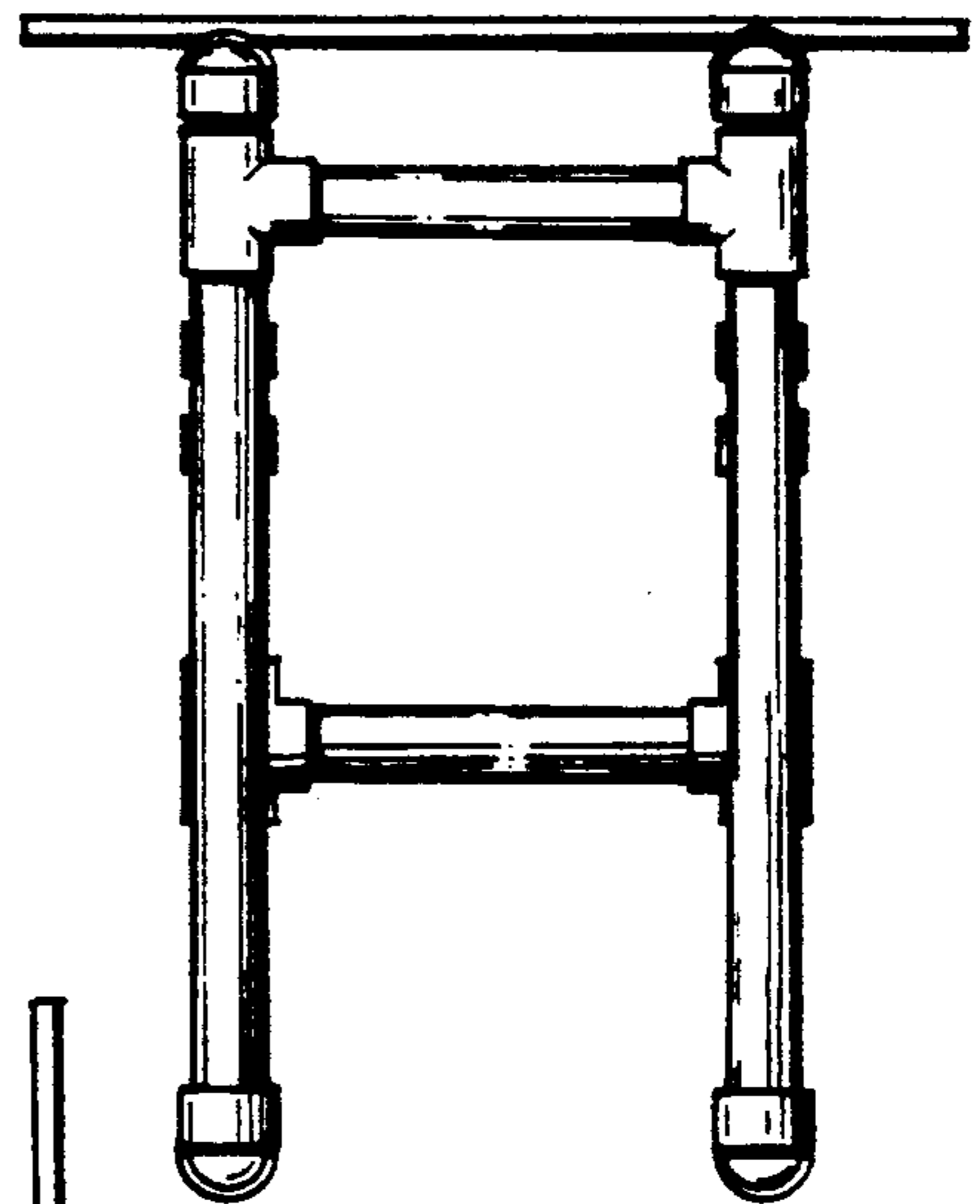

FIG. 5

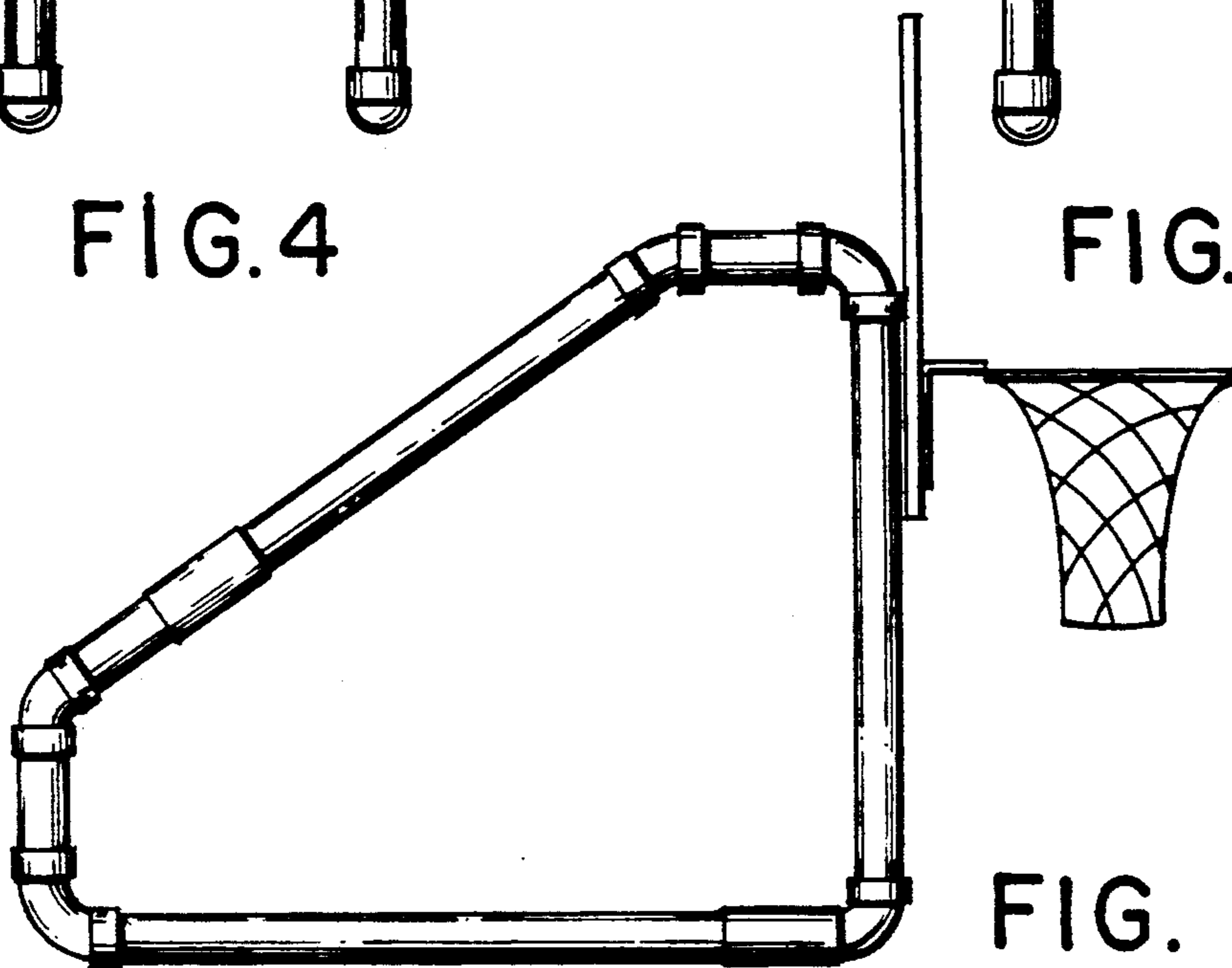

FIG. 6

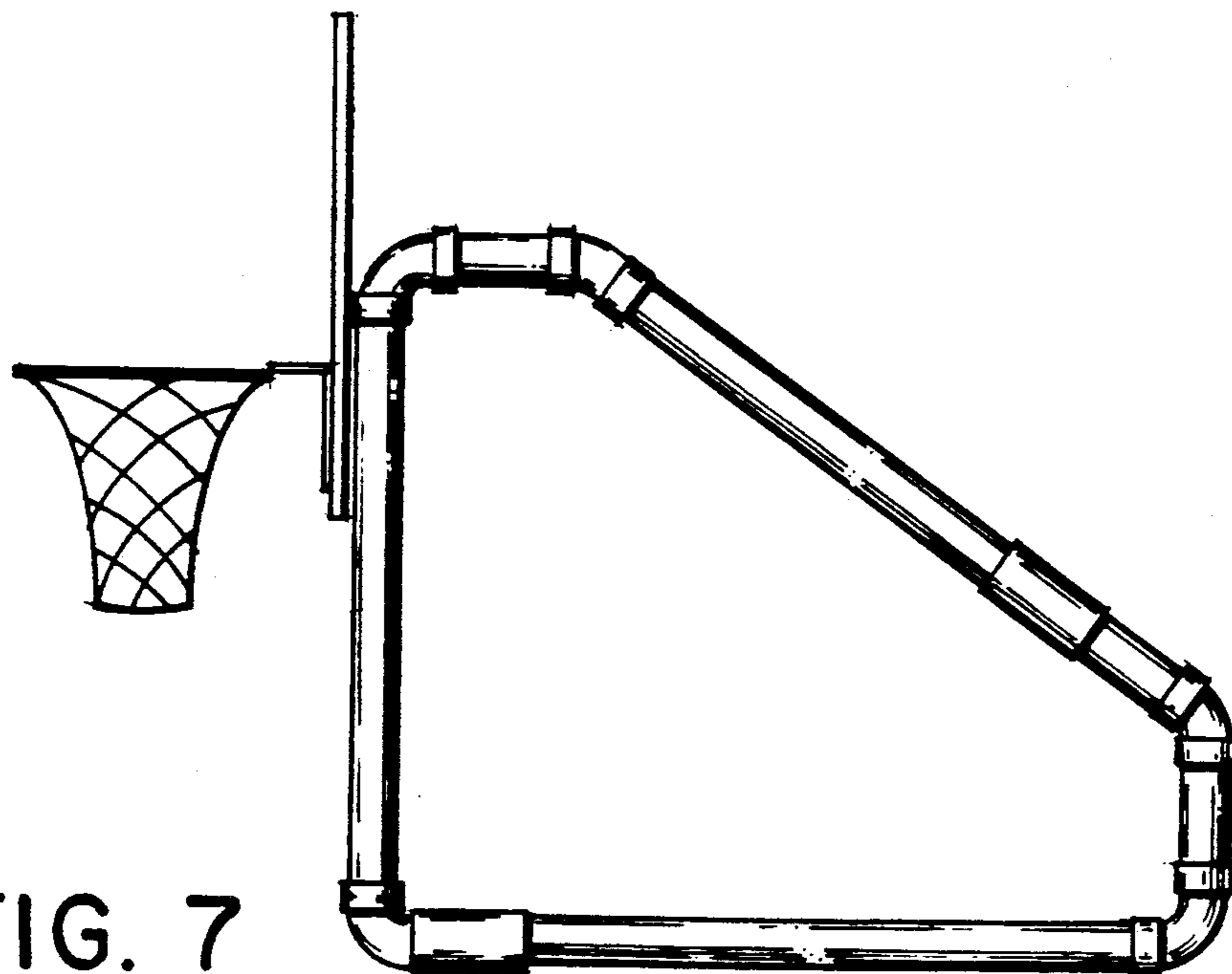

FIG. 7