

United States Patent [19]

Thurler et al.

[11] Patent Number: Des. 322,016

[45] Date of Patent: ** Dec. 3, 1991

[54] RIGHT ANGLE SANDER/GRINDER

[75] Inventors: James E. Thurler, Pickens, S.C.;
Philip J. Snoke, Atlanta; Devin L.
Moore, Decatur, both of Ga.

[73] Assignee: Ryobi Motor Products Corp.,
Pickens, S.C.

[**] Term: 14 Years

[21] Appl. No.: 327,580

[22] Filed: Mar. 23, 1989

[52] U.S. Cl. D8/62

[58] Field of Search D8/61, 62, 67, 69, 70;
51/170 T, 170 R, 170 TL, 170 EB, 170 MT

[56] **References Cited**

U.S. PATENT DOCUMENTS

- D. 277,638 2/1985 Somers D8/62
D. 297,907 10/1988 Hoshimo et al. D8/62

- D. 301,830 6/1989 Ogawa et al. D8/62
D. 305,399 1/1990 Fushiya et al. D8/62
D. 305,606 1/1990 Cavedo D8/62

Primary Examiner—Nelson C. Holtje
Assistant Examiner—J. H. Musgrove
Attorney, Agent, or Firm—David L. Davis

[57] **CLAIM**

The ornamental design for a right angle sander/grinder, as shown and described.

DESCRIPTION

FIG. 1 is a front perspective view of a right angle sander/grinder showing our new design;
FIG. 2 is a front elevational view thereof;
FIG. 3 is a rear elevational view thereof;
FIG. 4 is a left side elevational view thereof;
FIG. 5 is a right side elevational view thereof;
FIG. 6 is a top plan view thereof; and
FIG. 7 is a bottom plan view thereof.

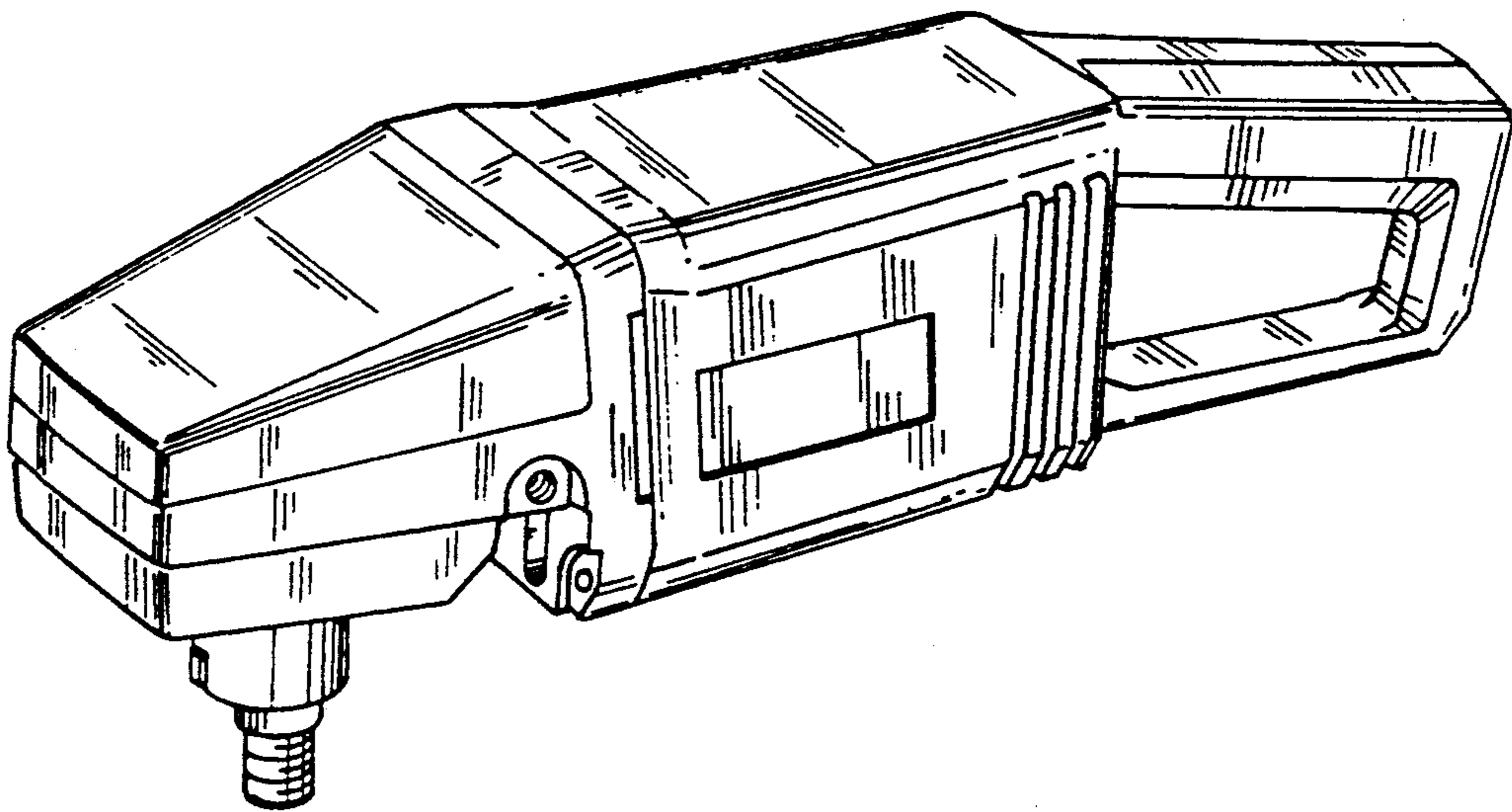

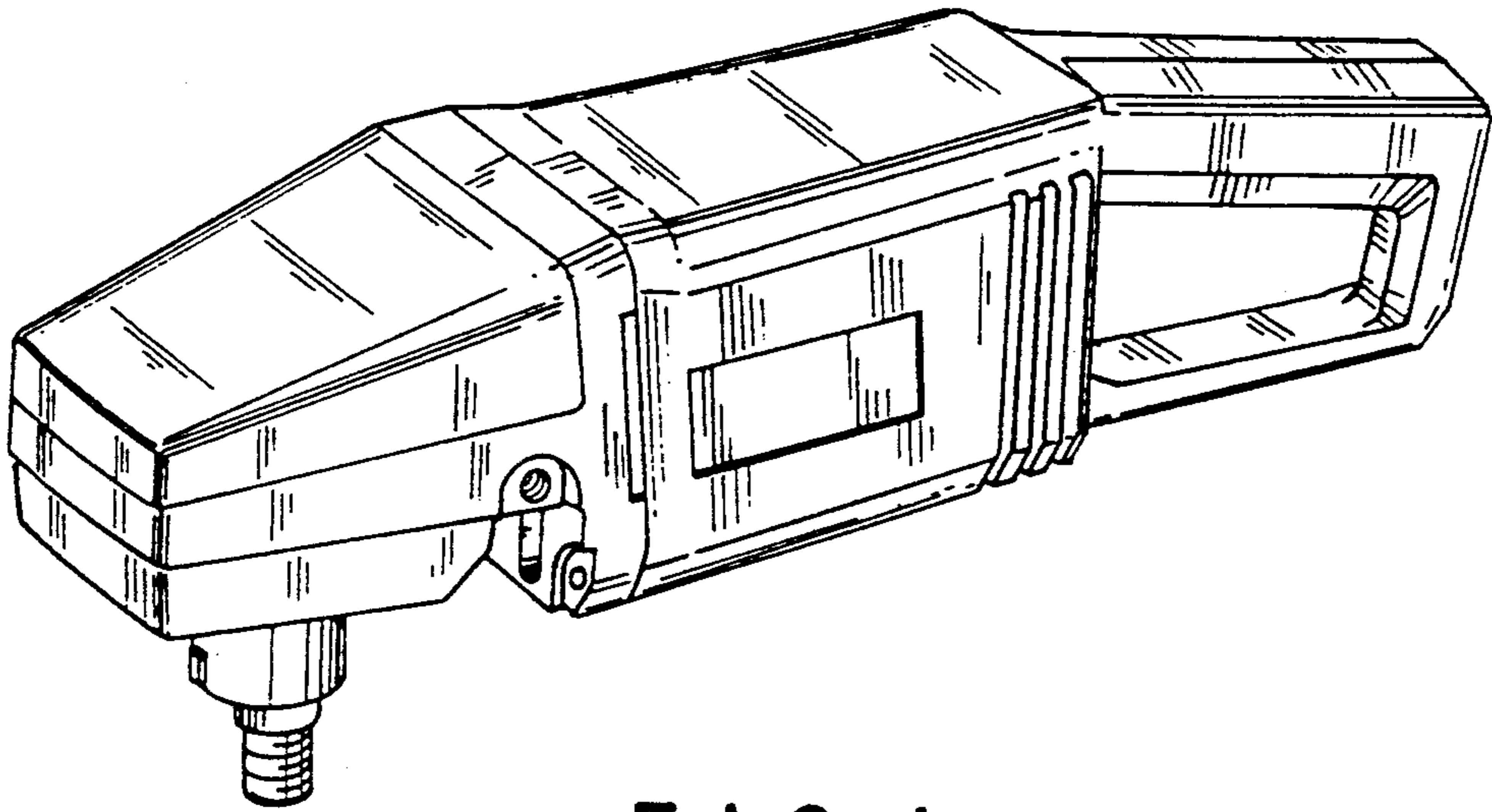

FIG. 1

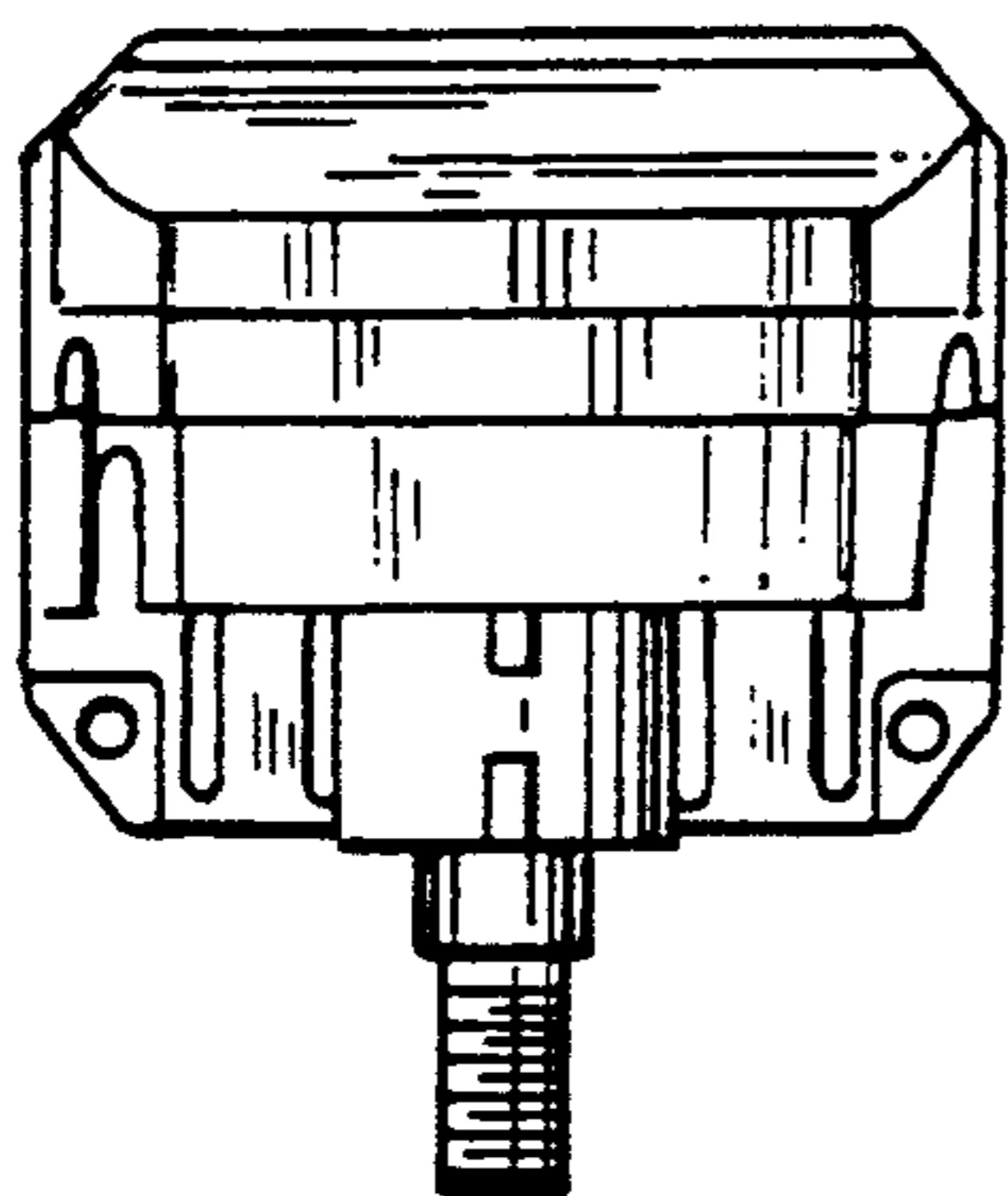

FIG. 2

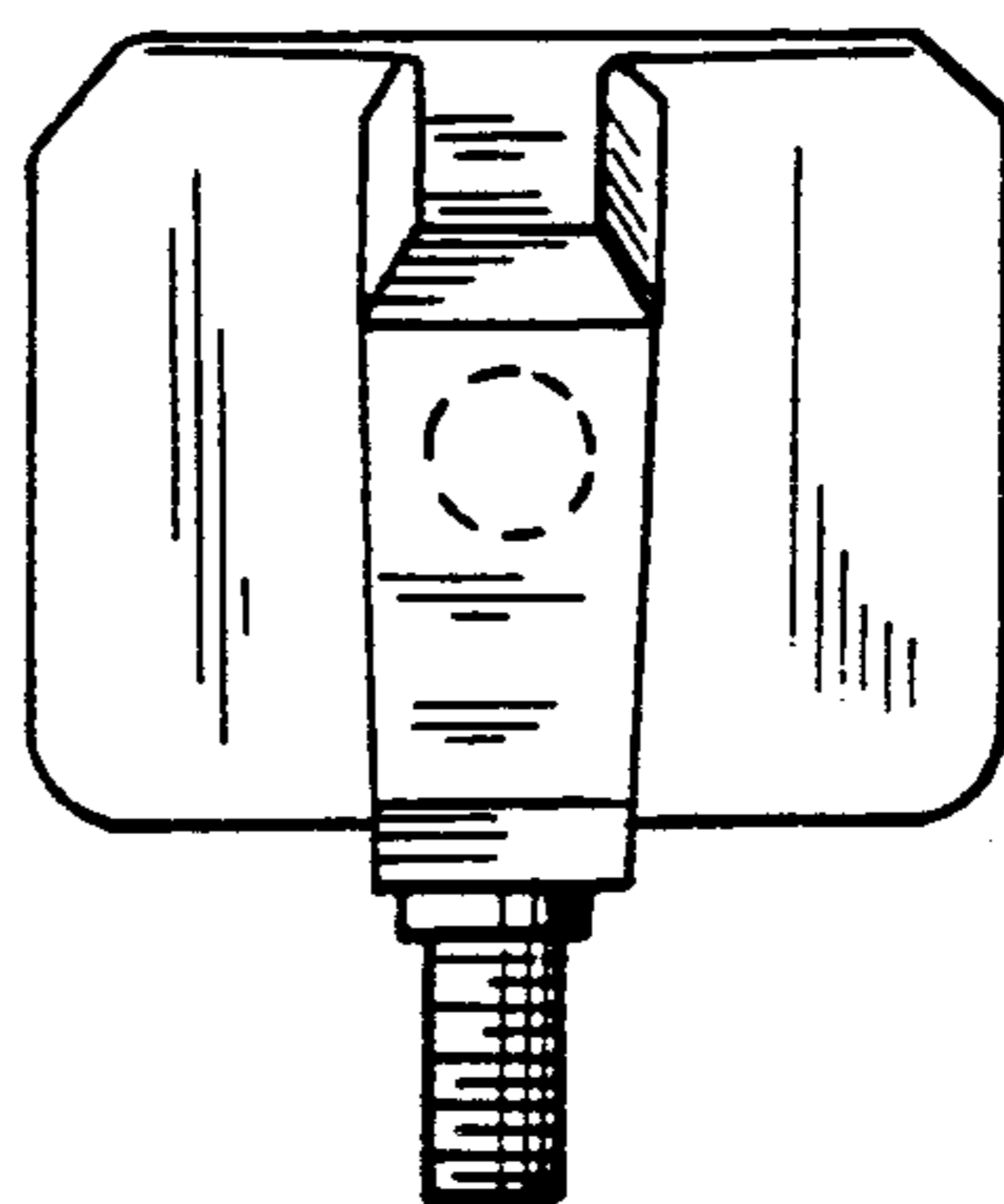

FIG. 3

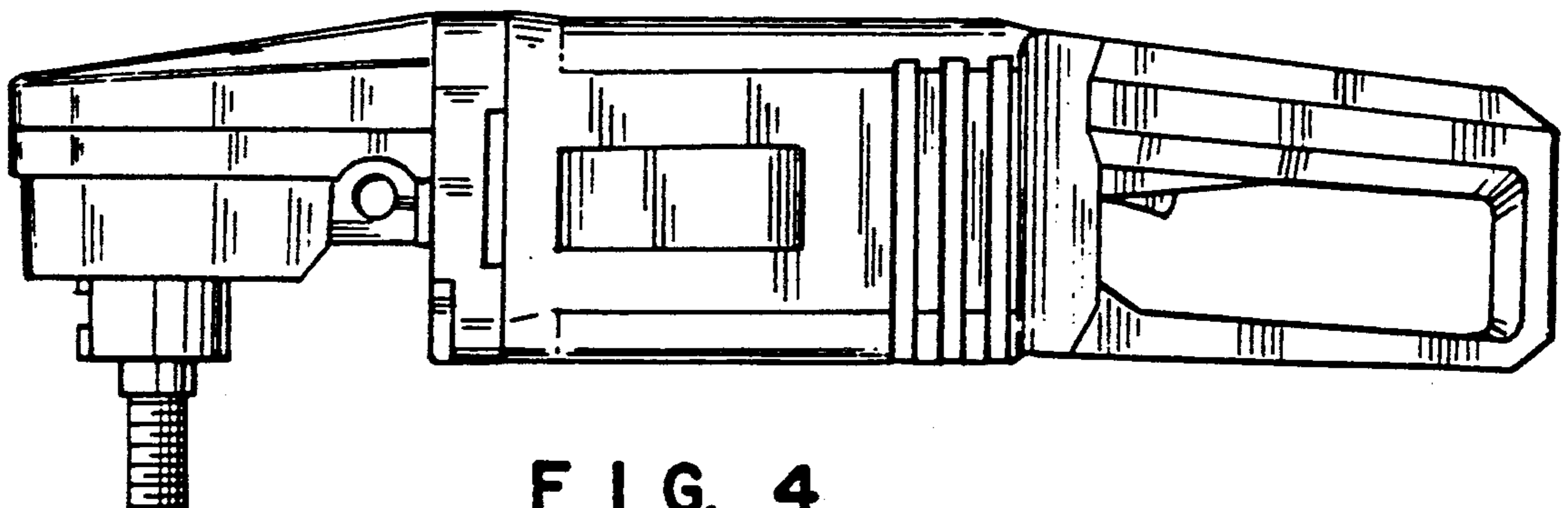

FIG. 4

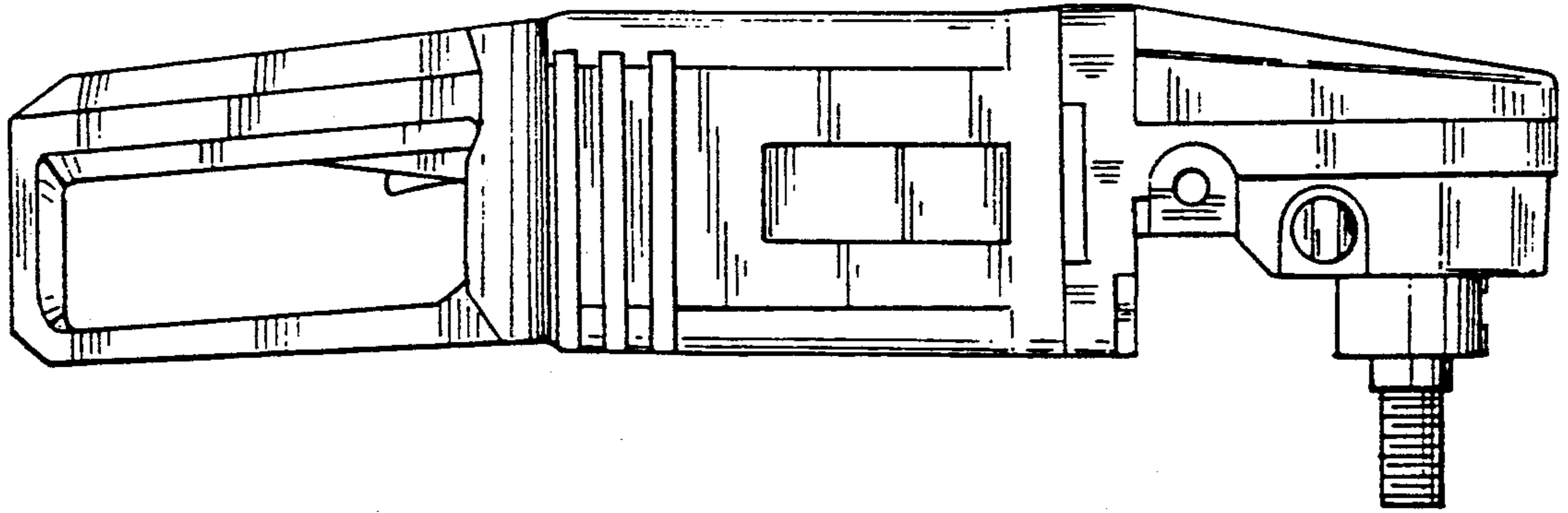

FIG. 5

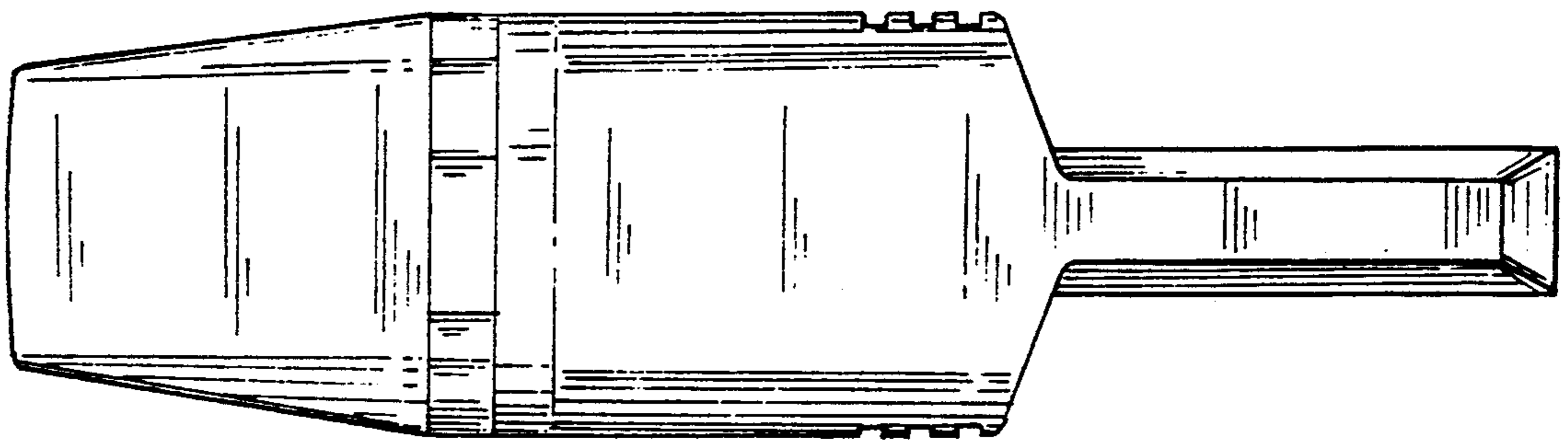

FIG. 6

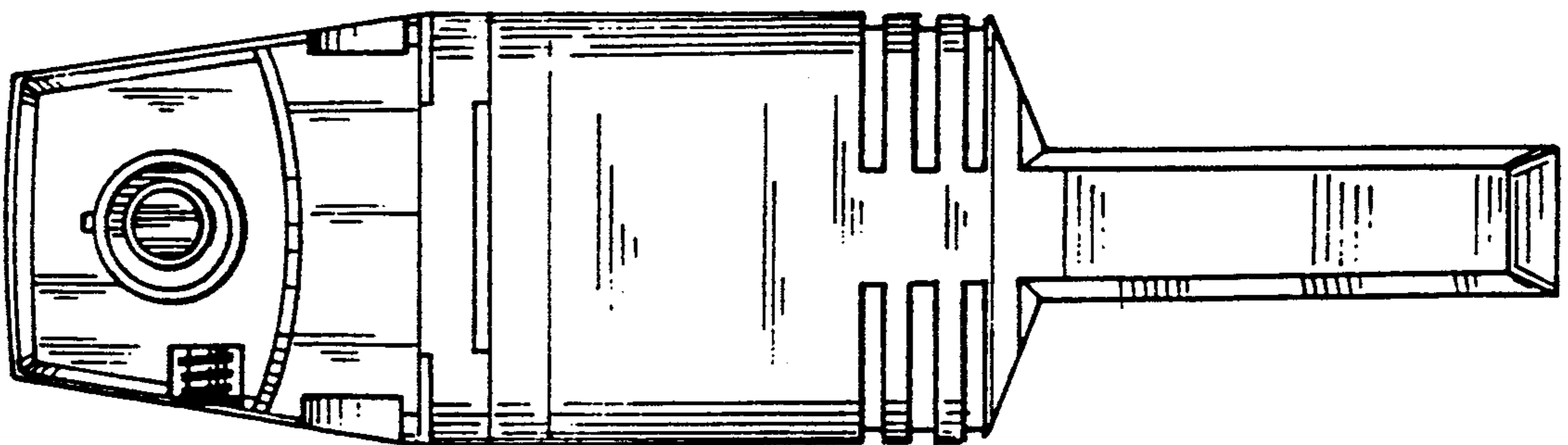

FIG. 7