

[54] **DISK STORAGE CASE**

[75] Inventor: **Makio Hasuike, Milan, Italy**
[73] Assignee: **Seima Italiana SpA, Tolmezzo, Italy**
[**] Term: **14 Years**
[21] Appl. No.: **144,856**
[22] Filed: **Jan. 15, 1988**

[30] **Foreign Application Priority Data**
Jul. 21, 1987 [IT] Italy 60408/87[U]
[52] U.S. Cl. **D6/446**
[58] Field of Search **D6/446, 448, 432;**
312/111, 209

[56] **References Cited**
U.S. PATENT DOCUMENTS
D. 277,816 3/1985 Kleinert et al. D6/446
D. 287,554 1/1987 Radtke D6/448 X
D. 291,633 9/1987 Merzon D6/446

OTHER PUBLICATIONS
Global, ©1987, p. 44; Storage Cabinet #104830, top left center on page.
Primary Examiner—Carmen H. Vales-Lado

Attorney, Agent, or Firm—Flynn, Thiel, Boutell & Tanis

[57] **CLAIM**
The ornamental design for a disk storage case, as shown and described.

DESCRIPTION

FIG. 1 is a perspective view of a disk storage case showing my new design;
FIG. 2 is a perspective view with one drawer in open condition;
FIG. 3 is a left side elevational view of FIG. 1, the right side being a mirror image thereof;
FIG. 4 is a front elevational view thereof;
FIG. 5 is a rear elevational view thereof;
FIG. 6 is a bottom plan view thereof;
FIG. 7 is a top plan view thereof;
FIG. 8 is a perspective view of a second embodiment of the disk storage case shown in FIG. 1;
FIG. 9 is a perspective view with the drawers in open condition;
FIG. 10 is a left side elevational view of FIG. 8, the right side being a mirror image thereof;
FIG. 11 is a front elevational view thereof;
FIG. 12 is a rear elevational view thereof;
FIG. 13 is a bottom plan view thereof; and
FIG. 14 is a top plan view thereof.

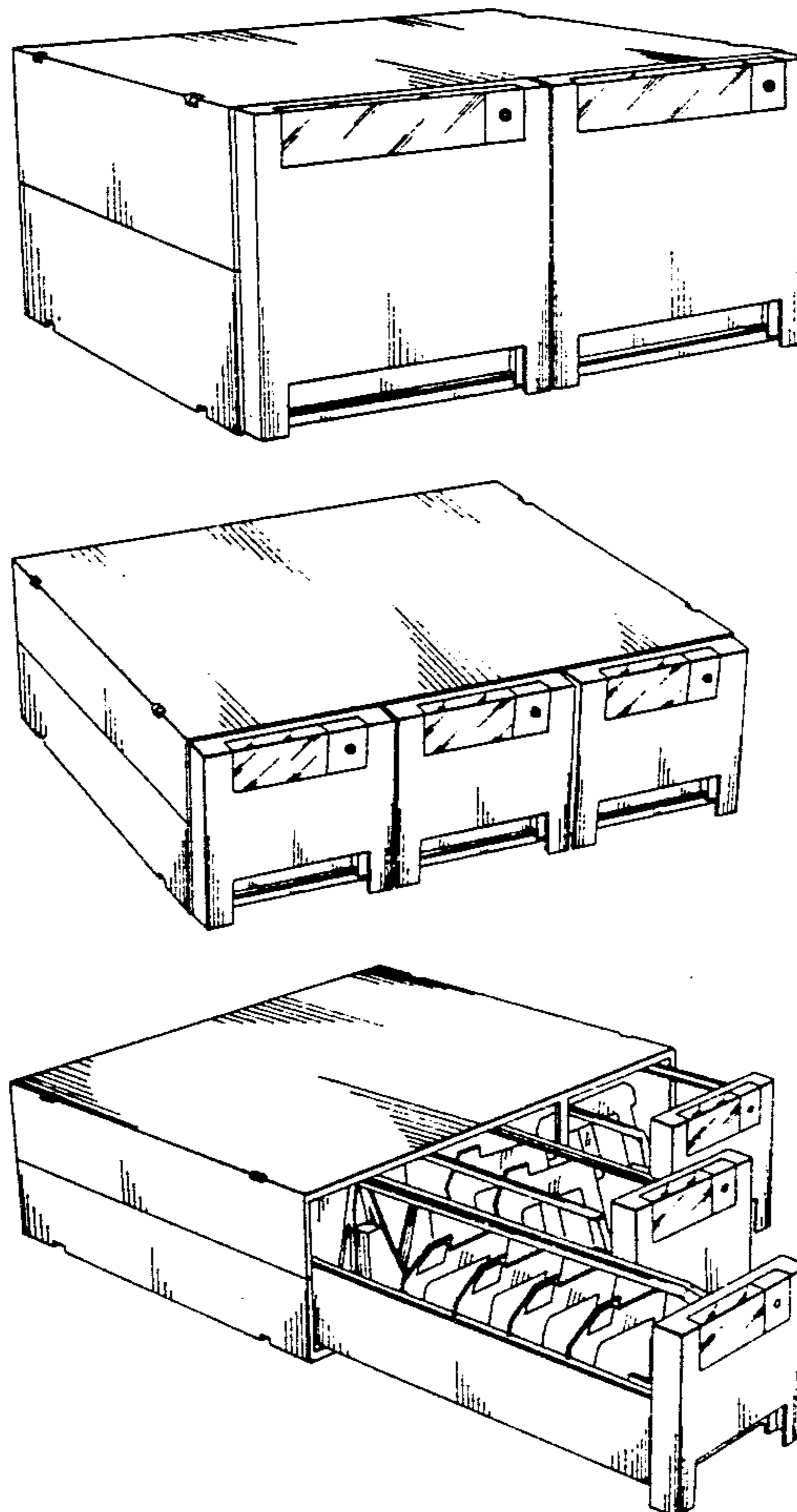

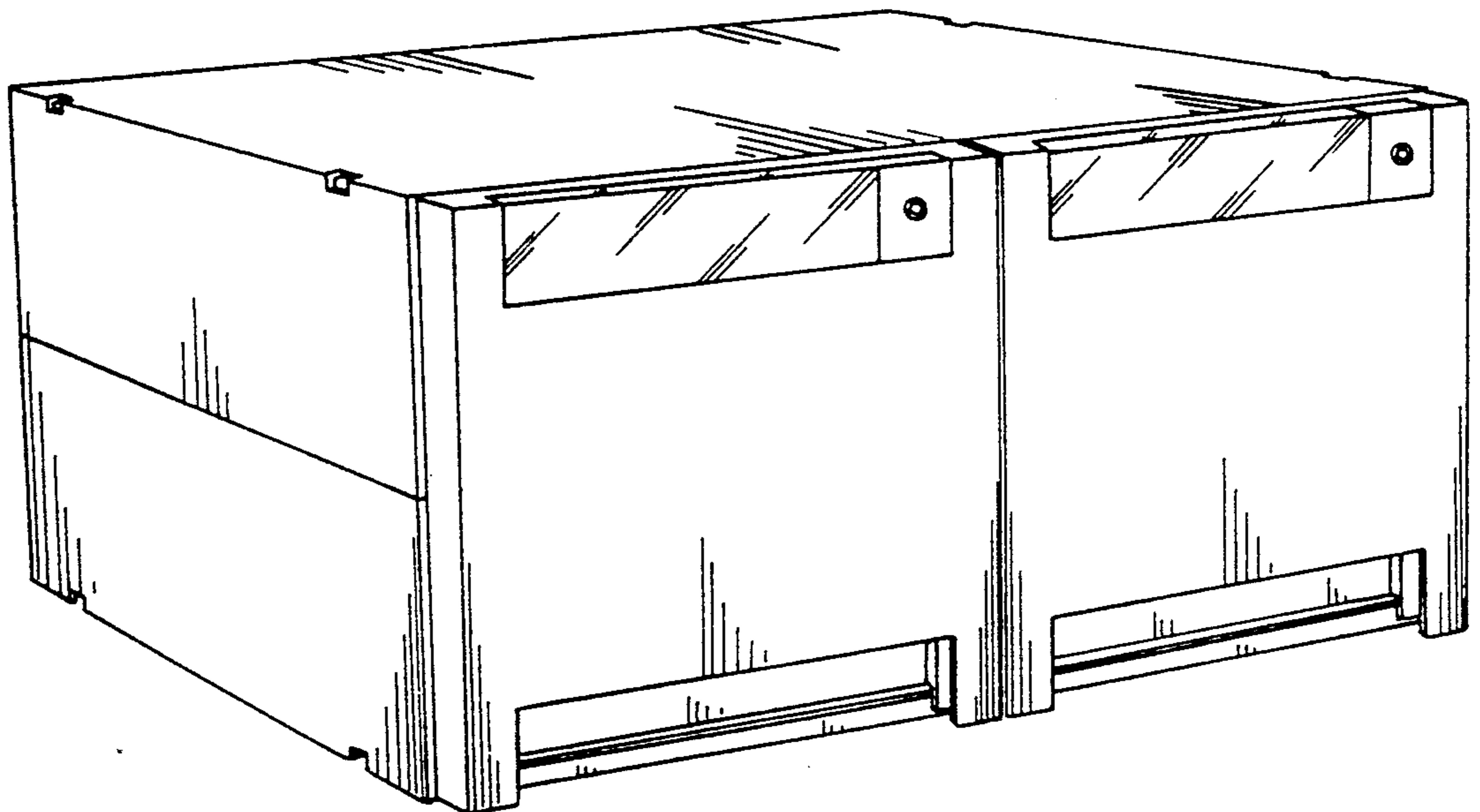

fig. 1

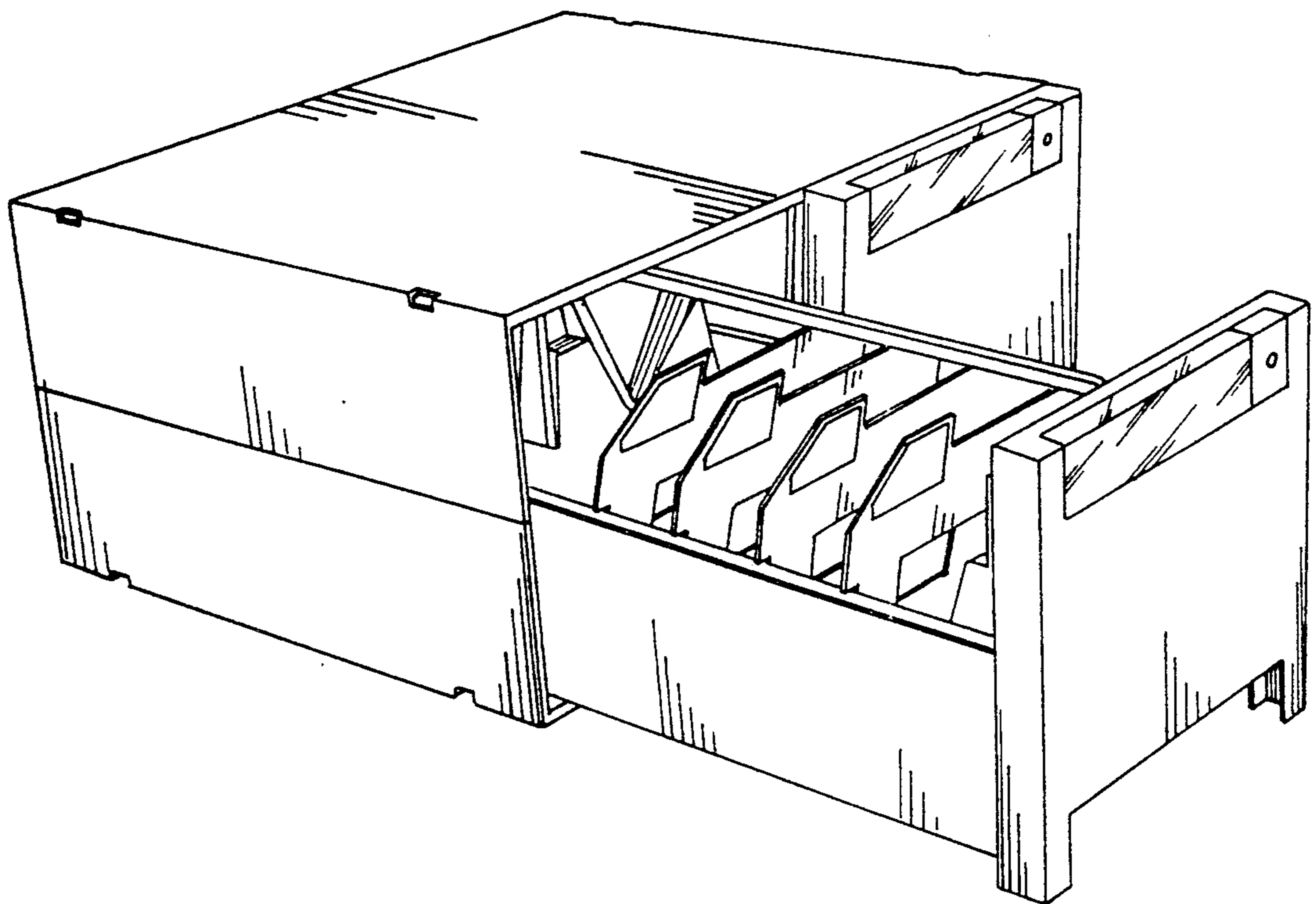

fig. 2

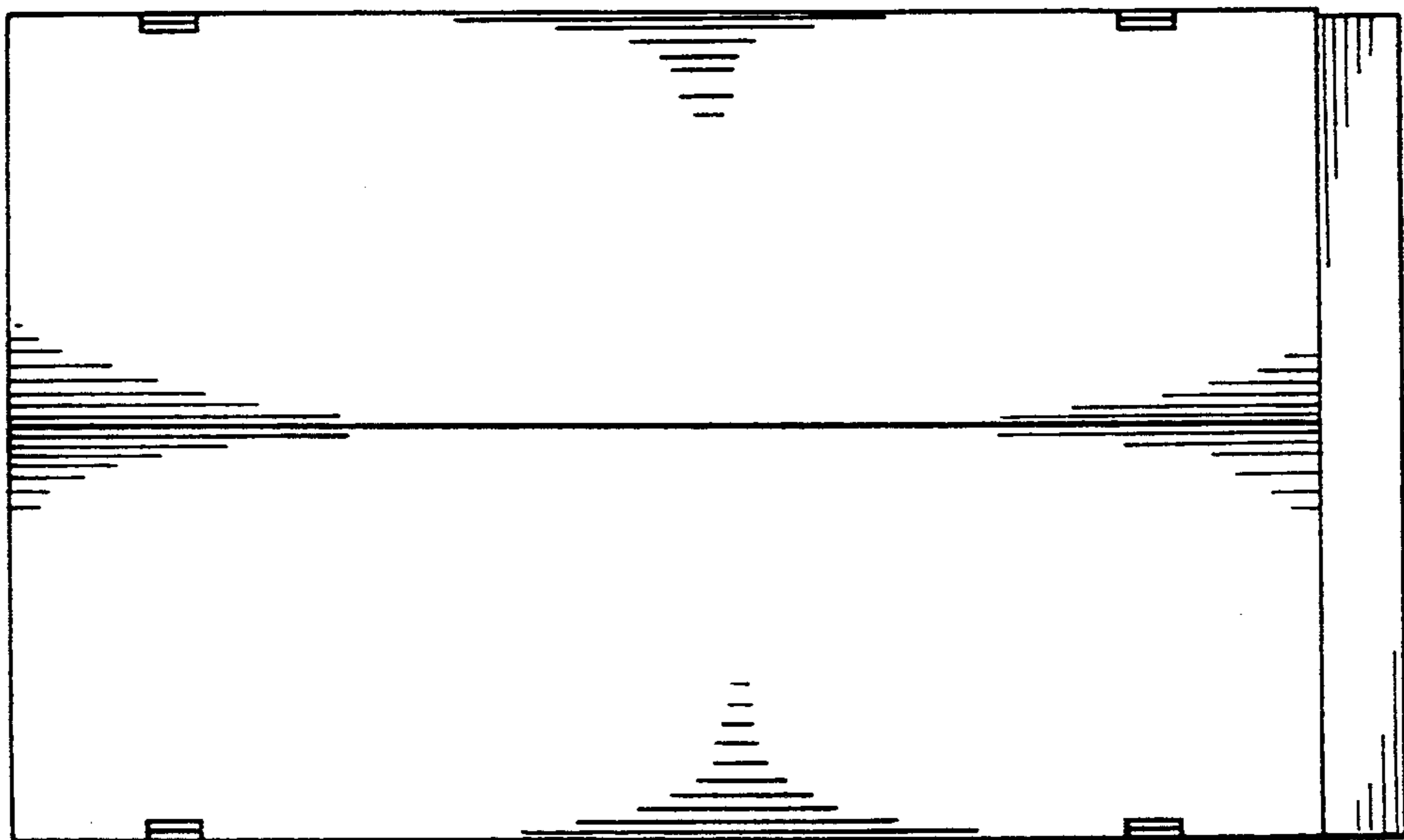

fig. 3

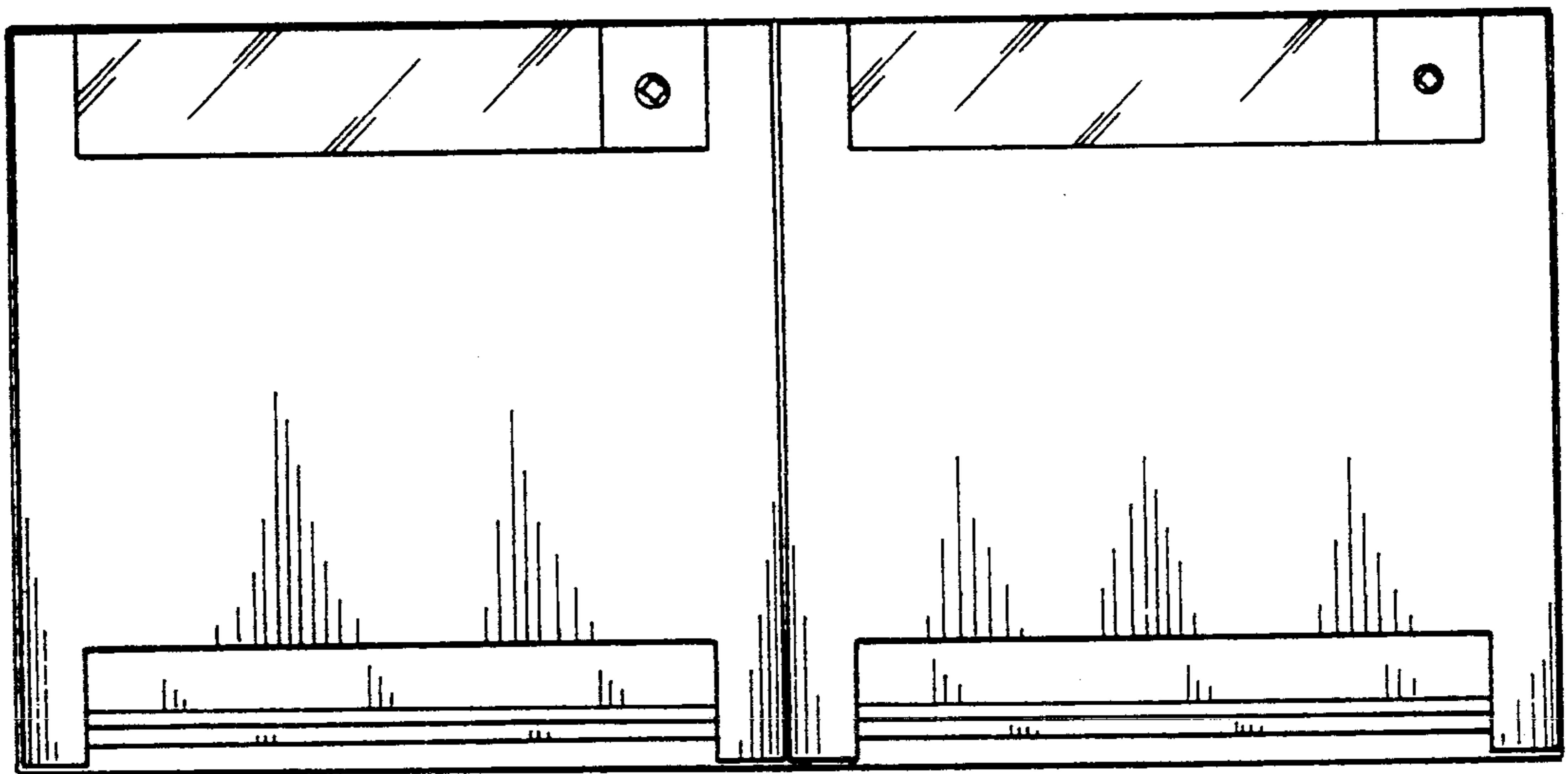

fig. 4

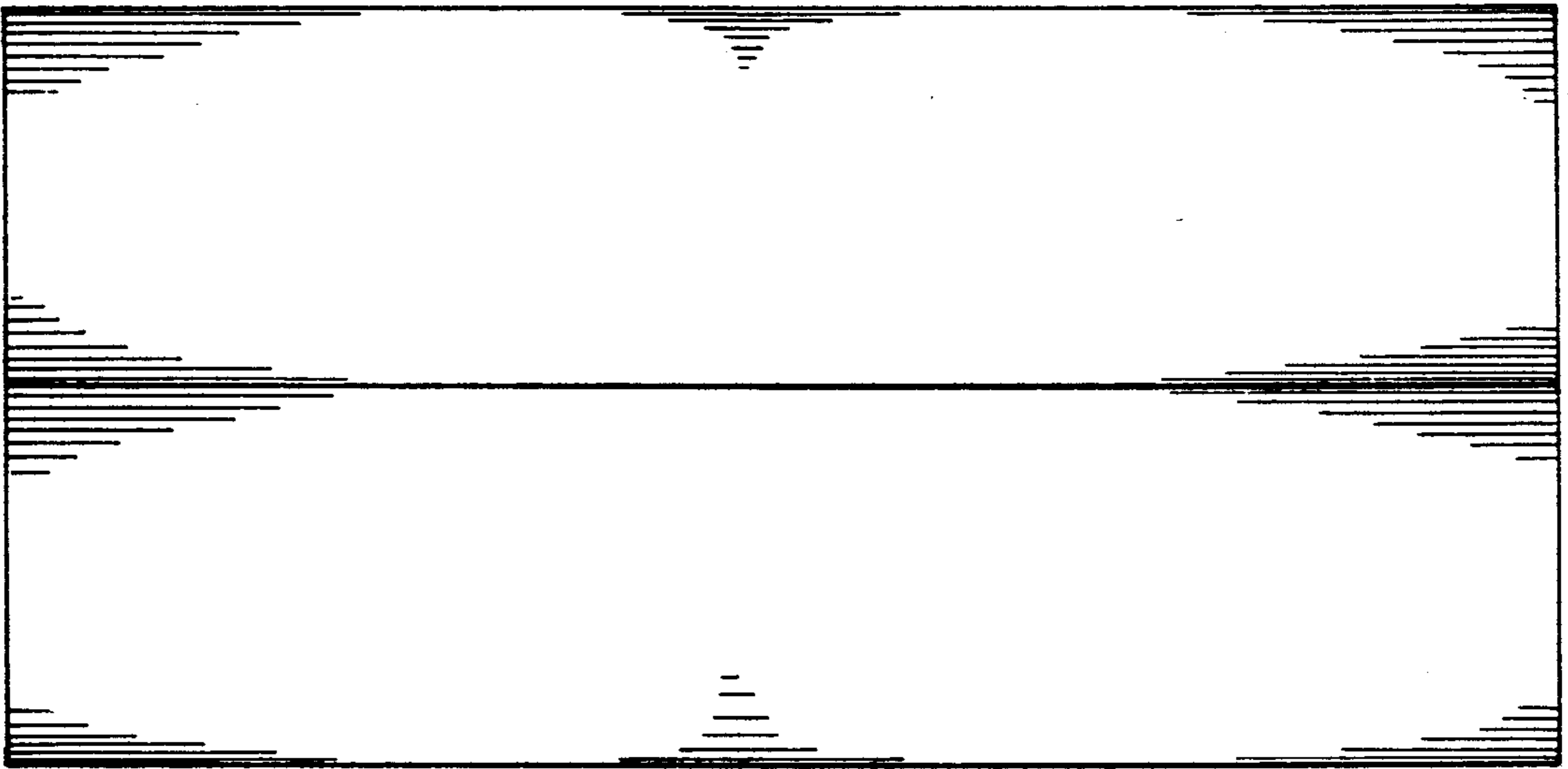

fig. 5

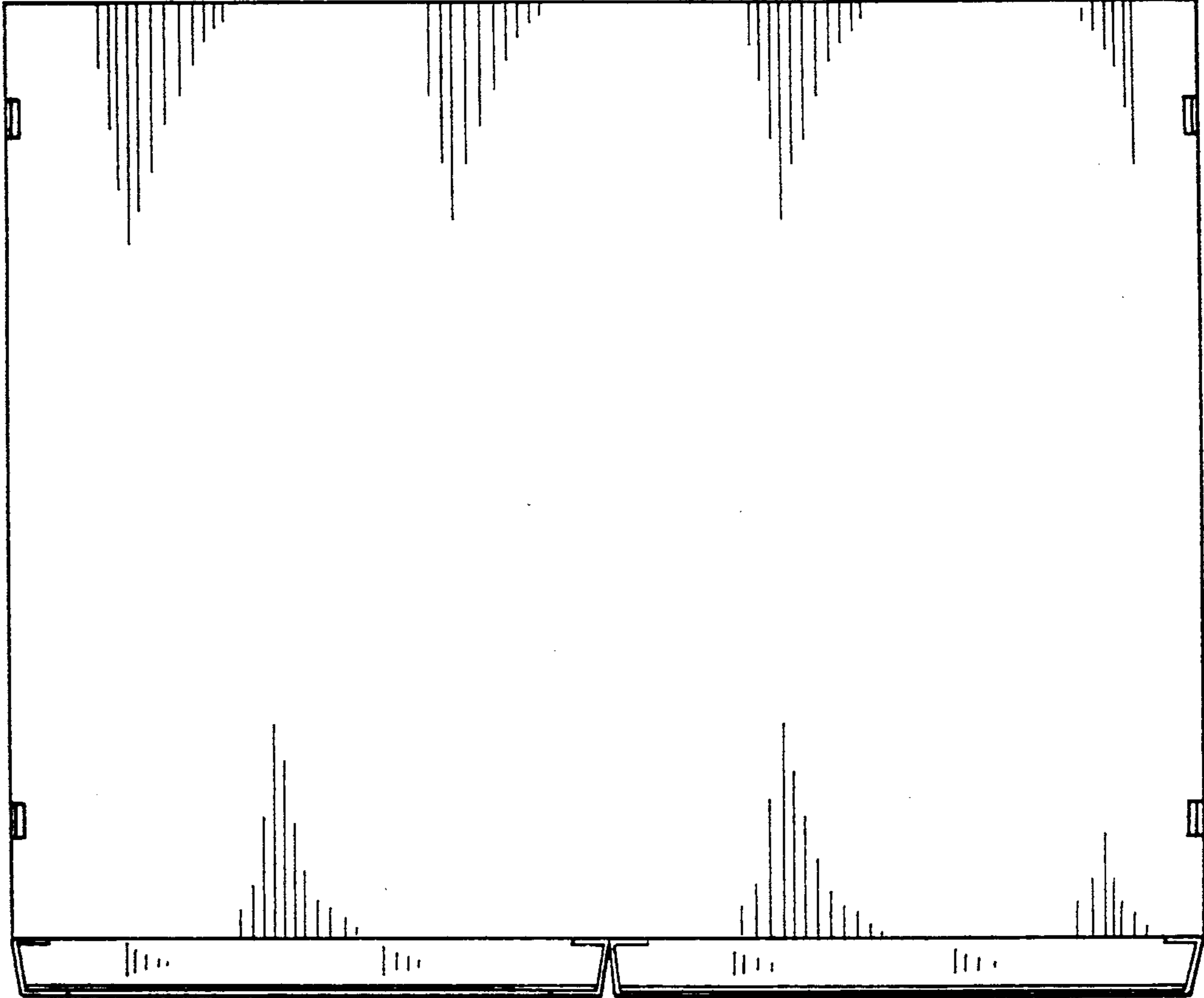

fig.6

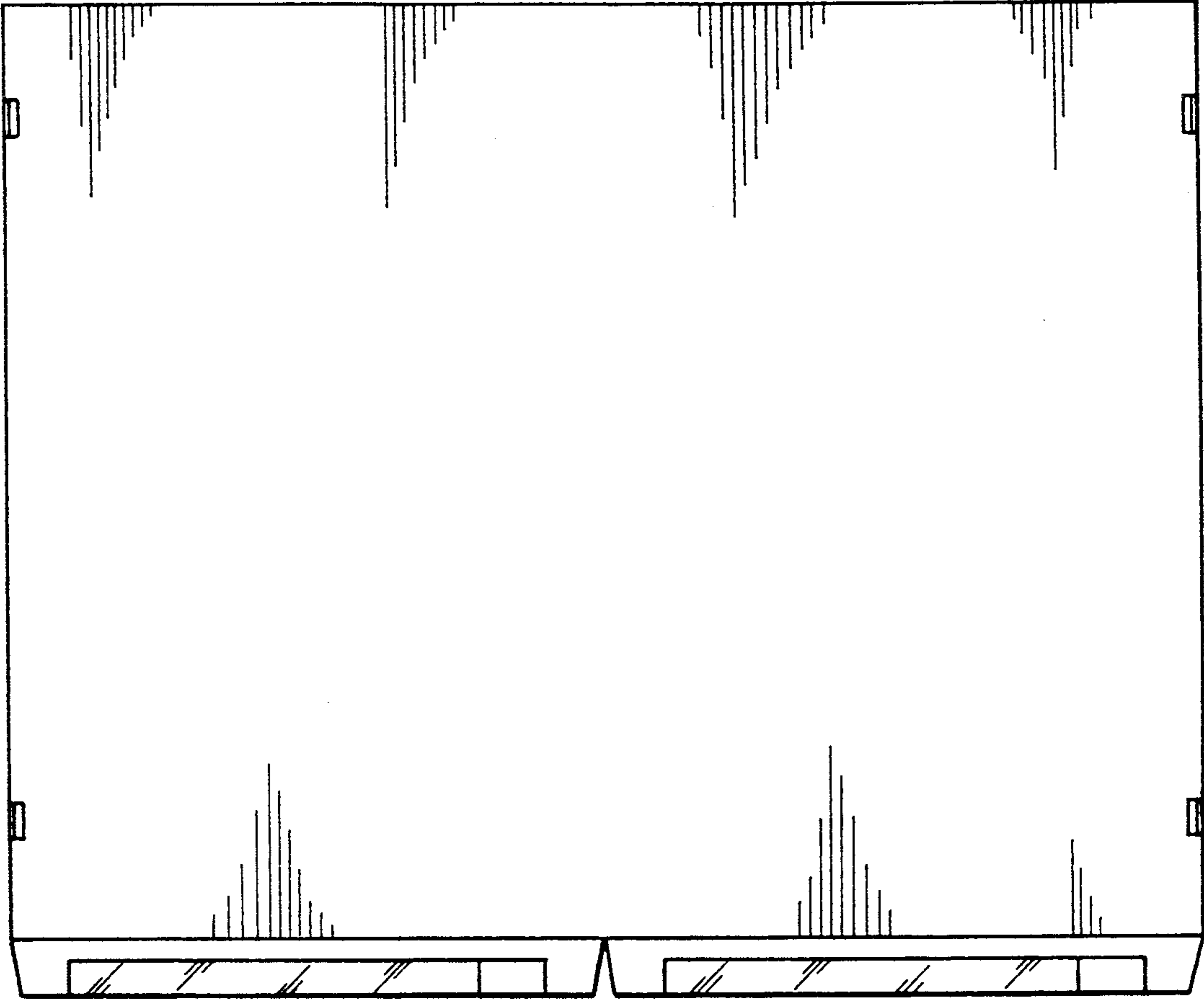

fig. 7

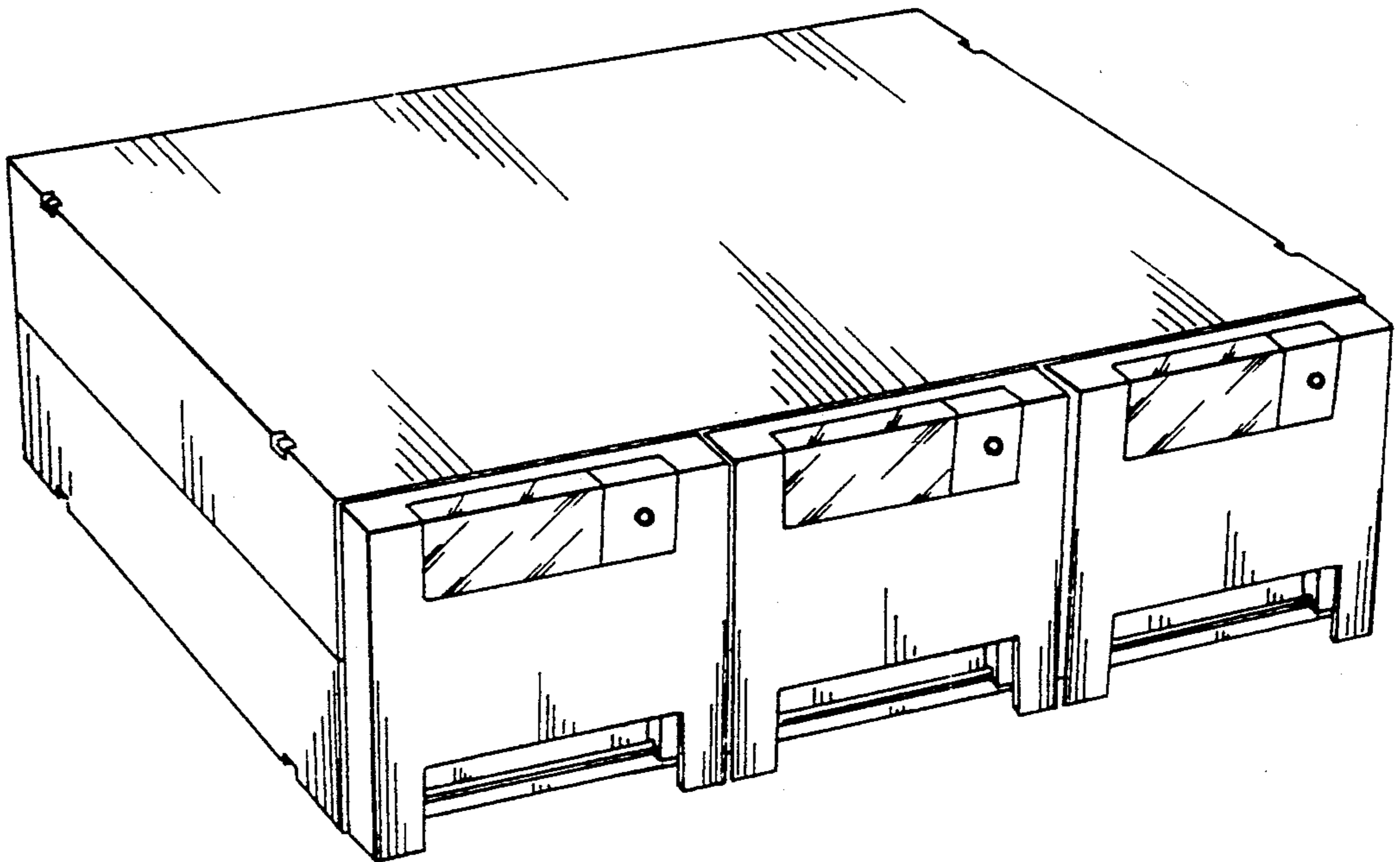

fig. 8

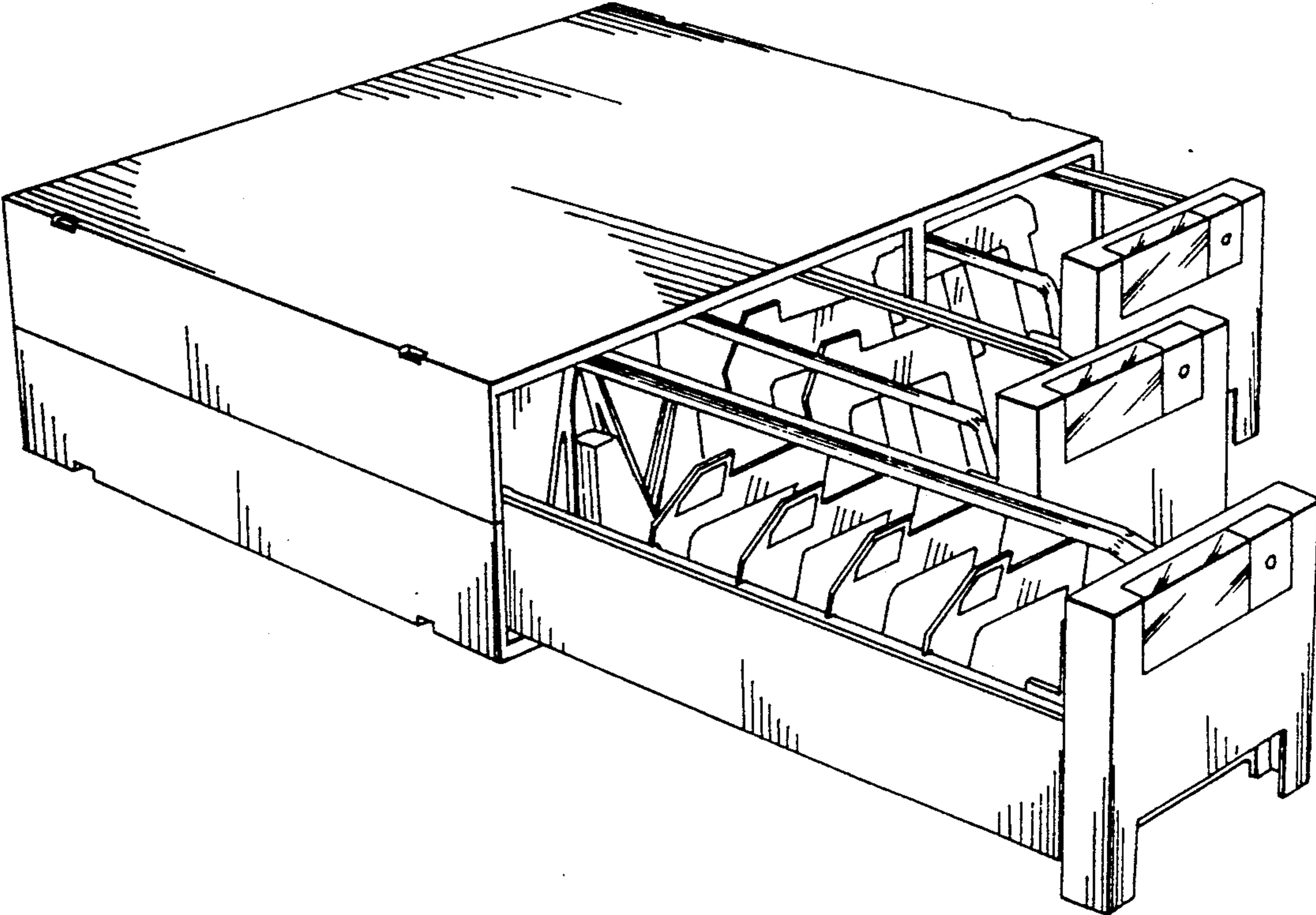

fig. 9

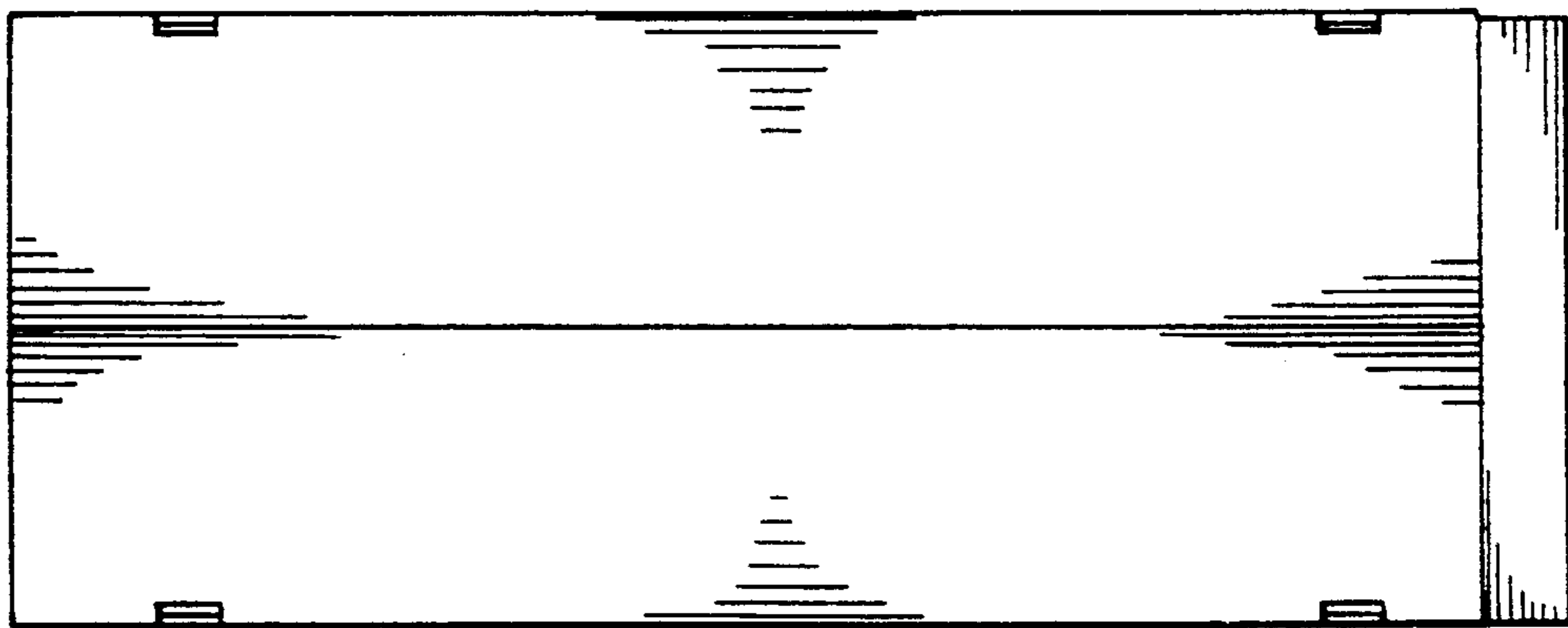

fig. 10

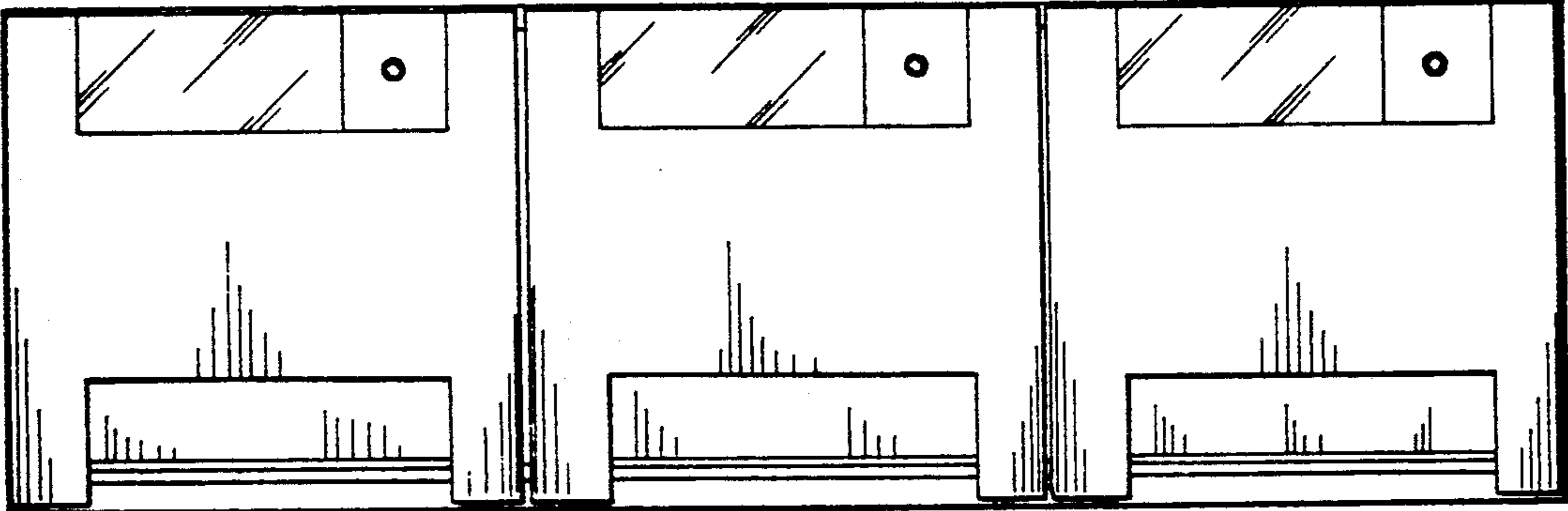

fig. 11

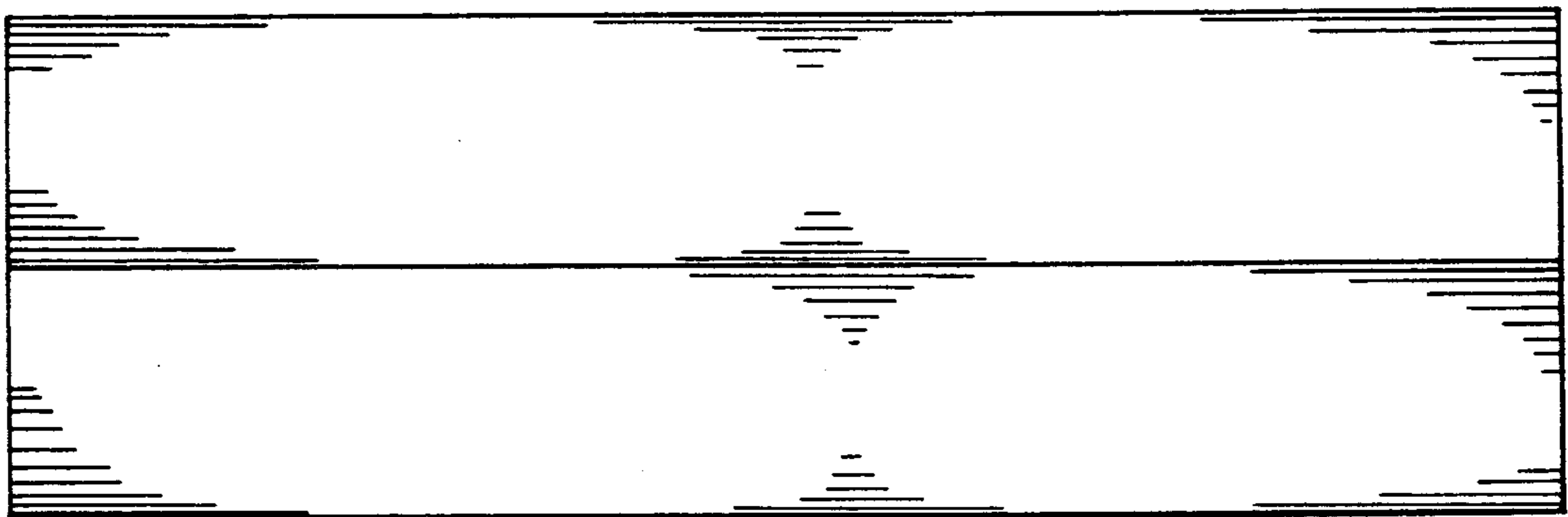

fig. 12

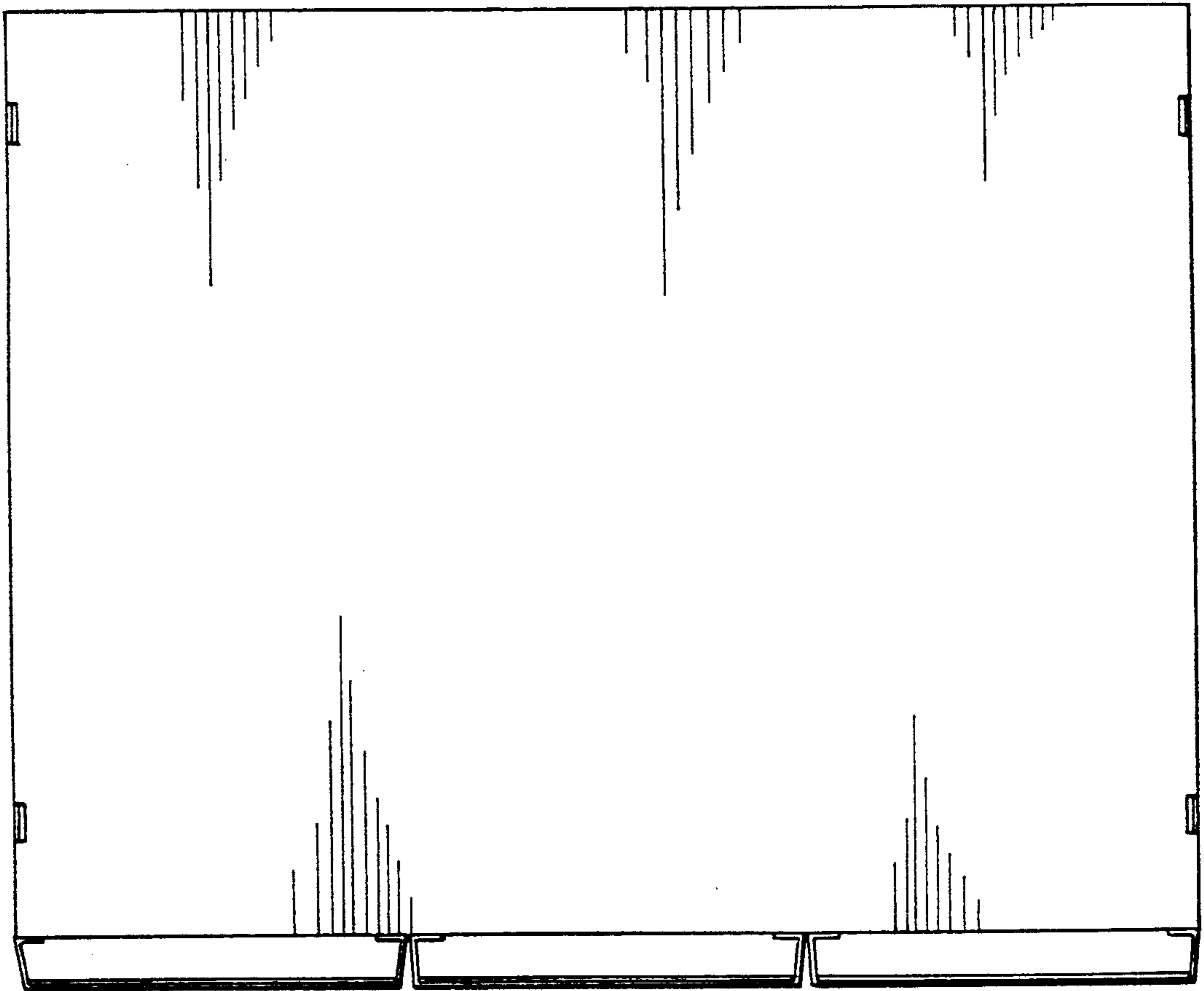

fig. 13

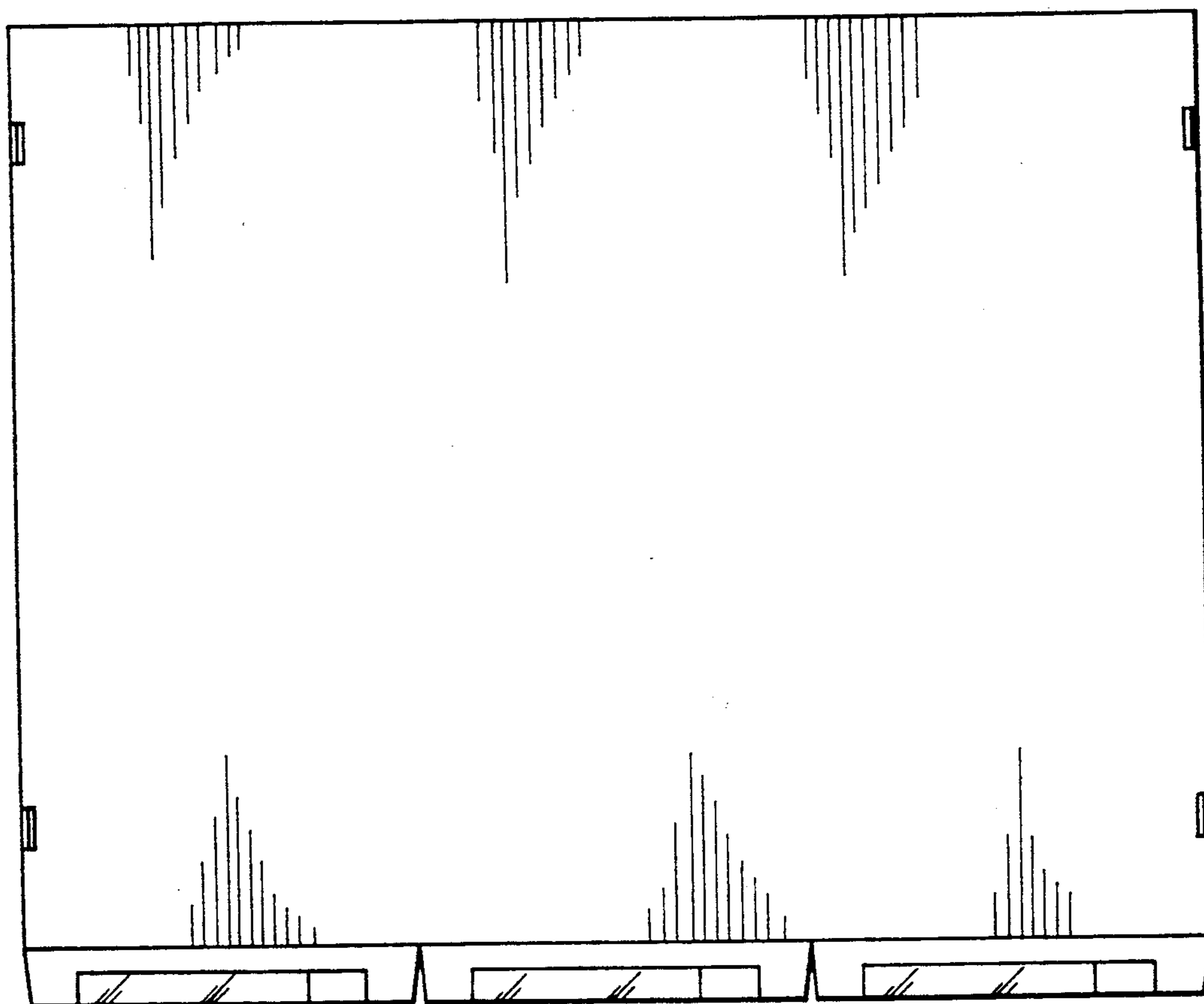

fig.14