

[54] SAND AND WATER PLAYBOX  
[76] Inventor: Peter W. Ross, R.R. No. 1,  
Frazerville, Ontario, Canada, K0L  
1V0

D. 264,629 5/1982 Longmire ..... D24/204  
D. 273,508 4/1984 Mariol ..... D21/252  
D. 308,574 6/1990 D'Innocente et al. .... D24/204  
3,660,957 5/1972 Schankler ..... D25/2

[\*\*] Term: 14 Years

Primary Examiner—Bruce W. Dunkins  
Assistant Examiner—Jeffrey Asch  
Attorney, Agent, or Firm—Arne I. Fors

[21] Appl. No.: 269,948

[22] Filed: Nov. 10, 1988

[57] CLAIM

[30] Foreign Application Priority Data

The ornamental design for a sand and water playbox, as shown and described.

May 11, 1988 [CA] Canada ..... 11-05-88-6

[52] U.S. Cl. .... D21/252; D24/204;  
D25/2

DESCRIPTION

[58] Field of Search ..... D21/252; D25/2;  
D24/204, 200; D6/475; 272/1 A

FIG. 1 is a front and right side perspective view of a sand and water playbox showing my new design; FIG. 2 is a rear elevational view; FIG. 3 is a top plan view; FIG. 4 is a right side elevational view, the left side having a mirror image thereof; FIG. 5 is a front elevational view, and FIG. 6 is a bottom plan view thereof. FIGS. 2-6 have been shown on an enlarged scale with respect to FIG. 1.

[56] References Cited

U.S. PATENT DOCUMENTS

D. 229,950 1/1974 Mitchko ..... D21/252  
D. 230,749 3/1974 Brooks ..... D21/252  
D. 245,541 8/1977 Melchior ..... D21/252 X  
D. 251,201 2/1979 Mathis ..... D25/2 X

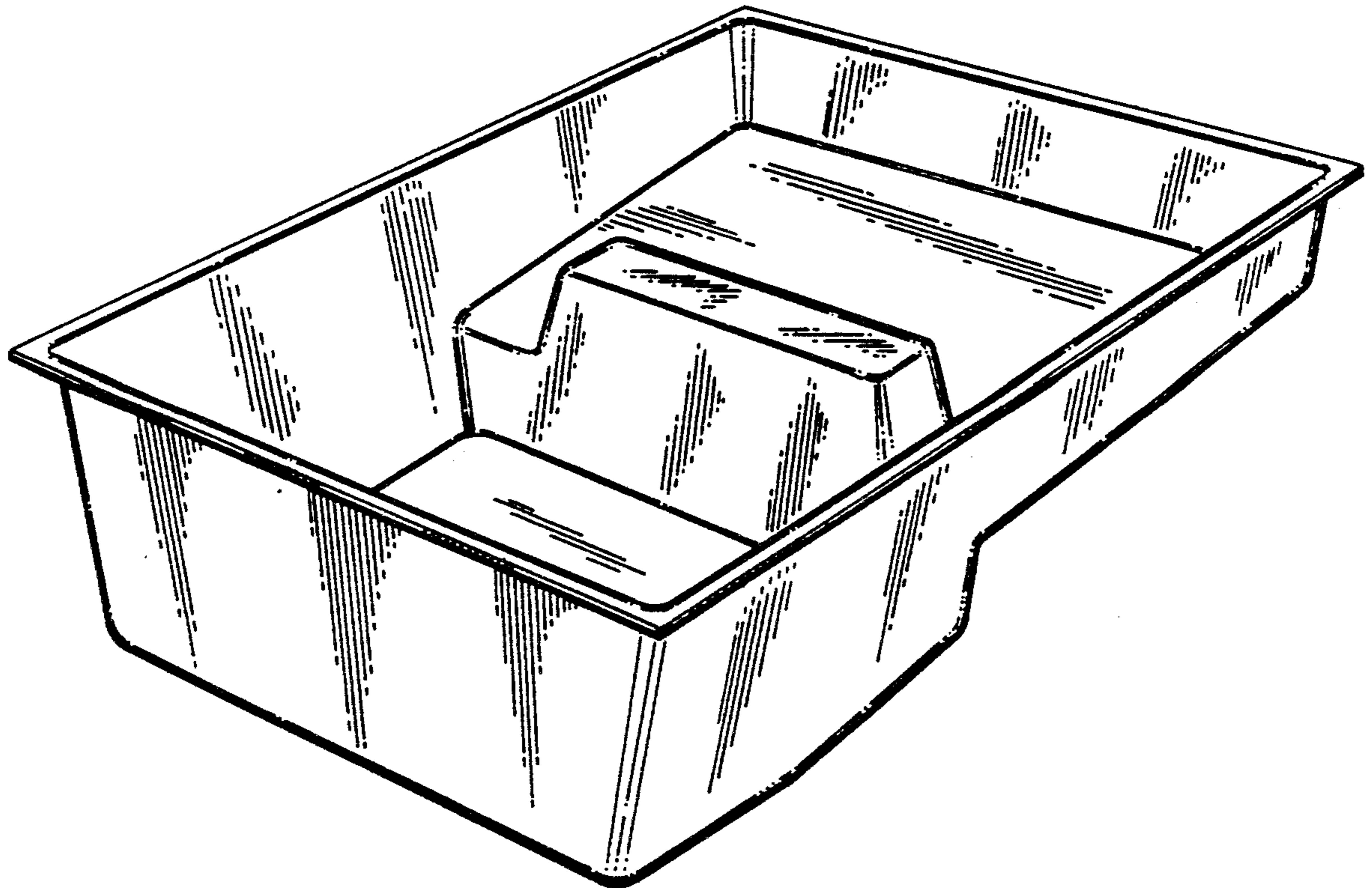

FIG.1.

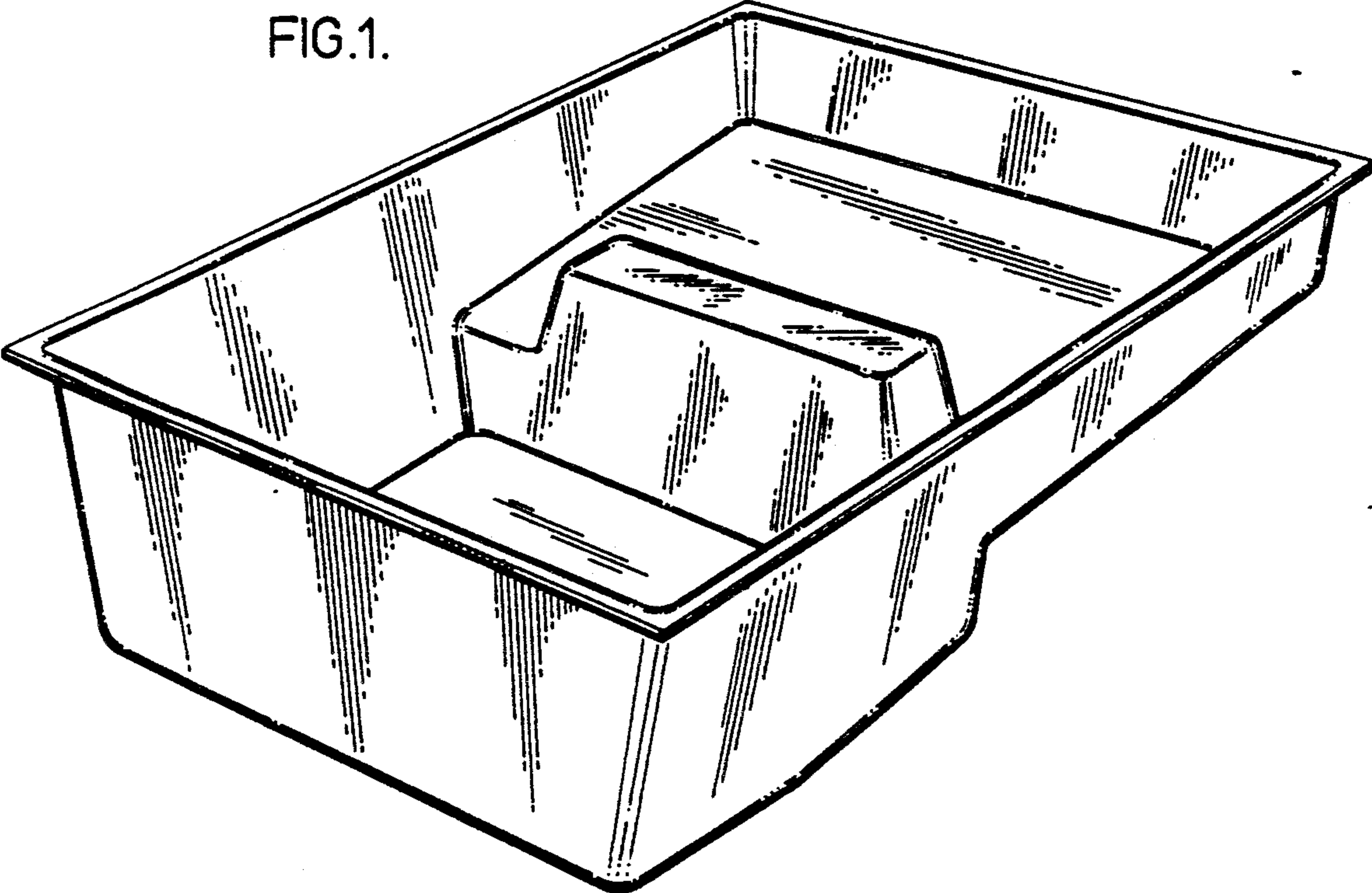
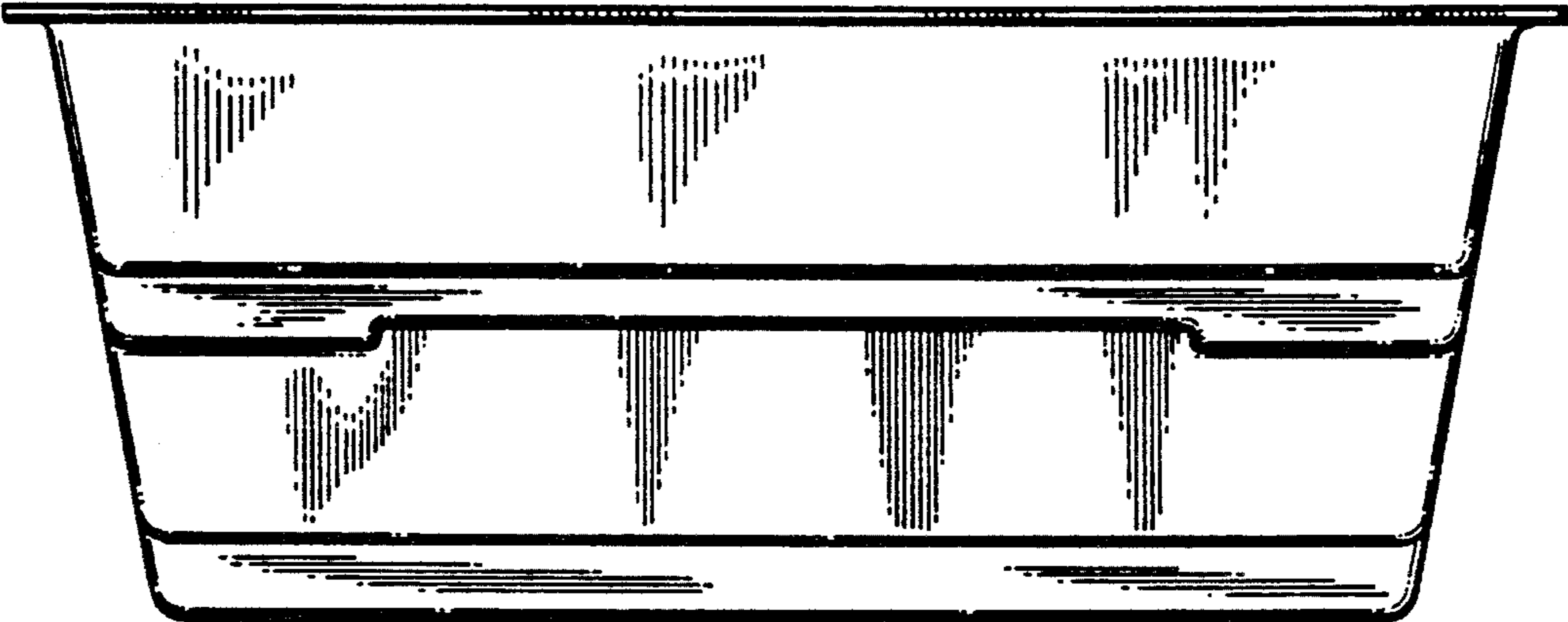

FIG. 2.



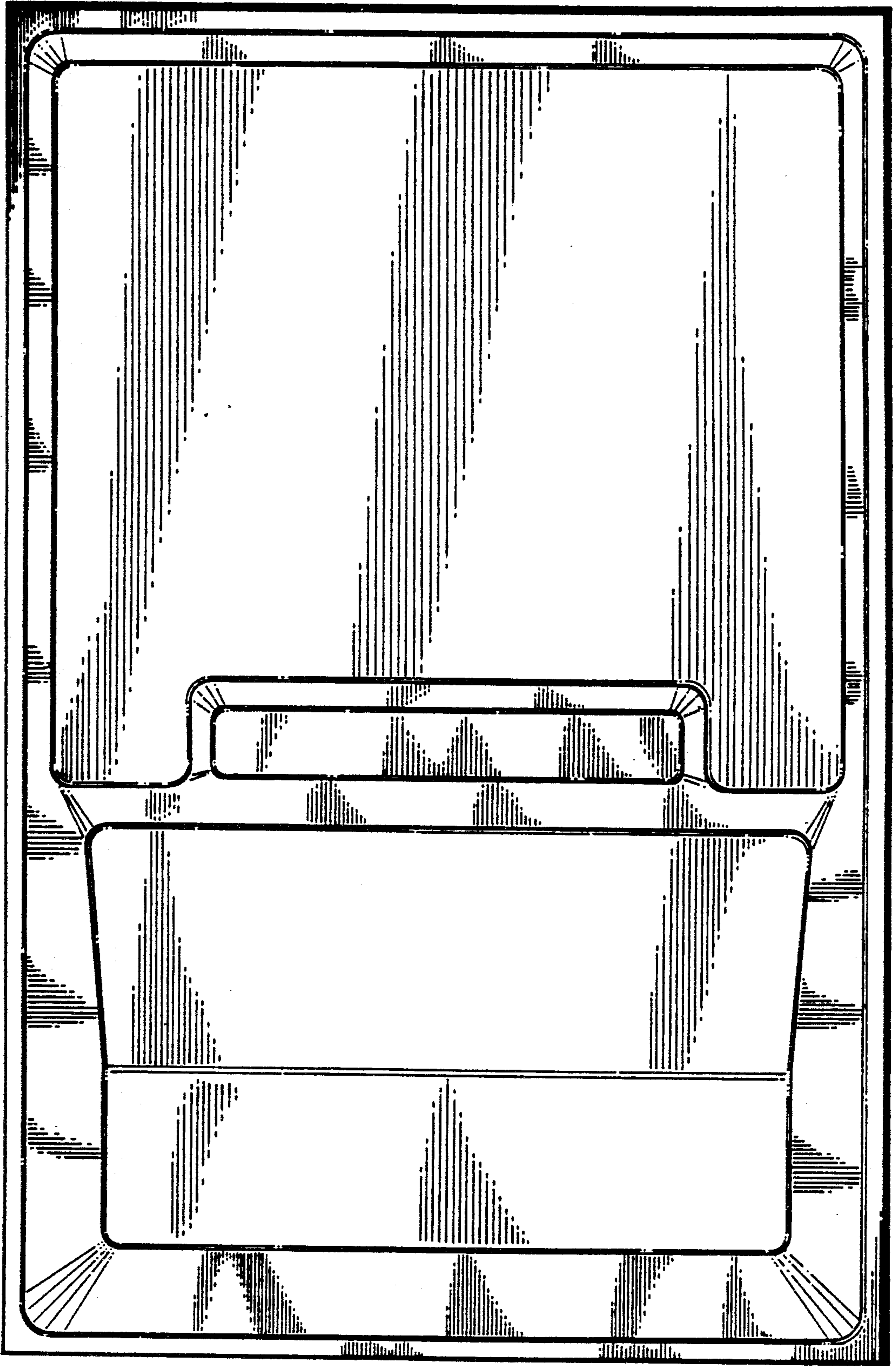

FIG. 3.

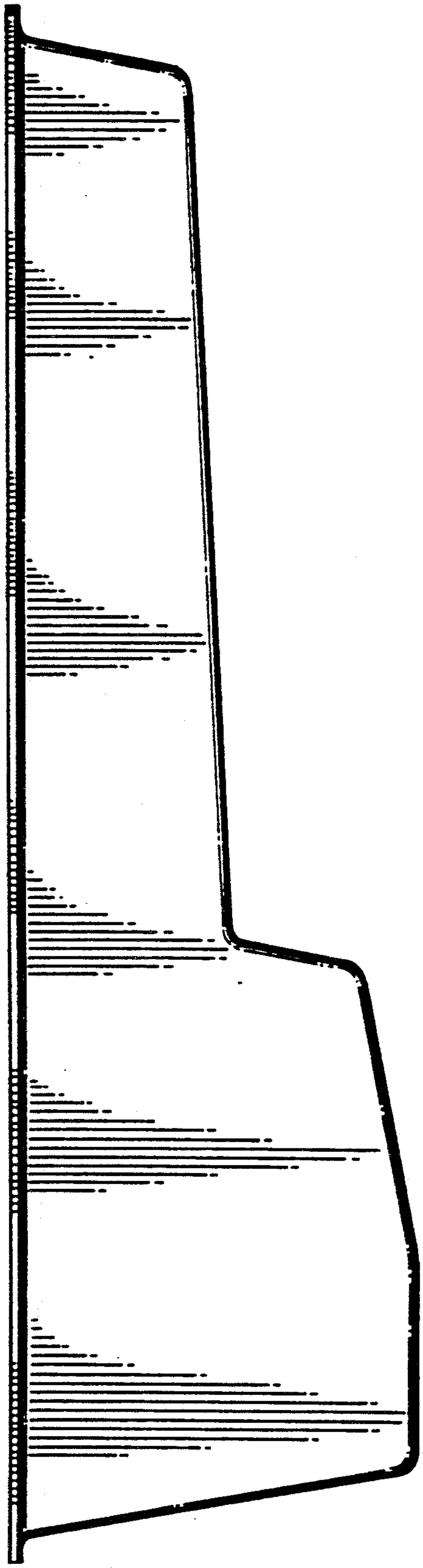

FIG. 4.

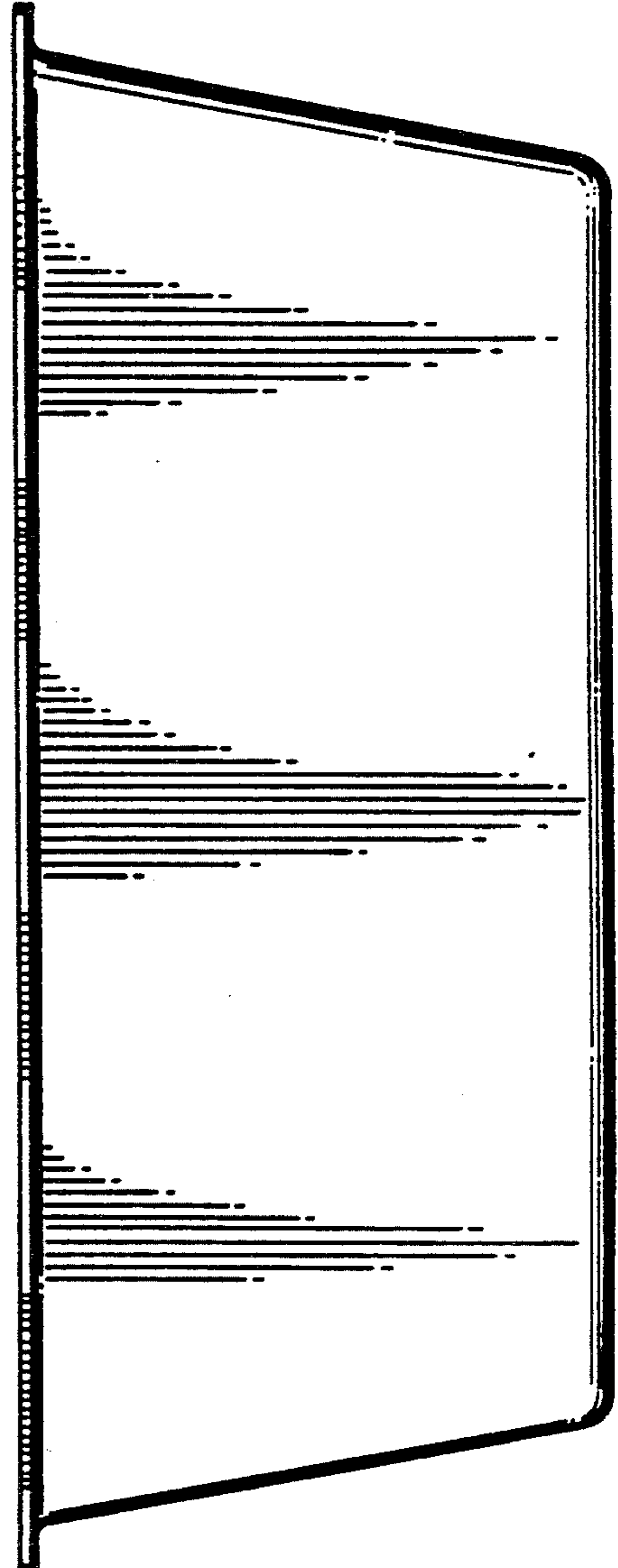

FIG. 5.

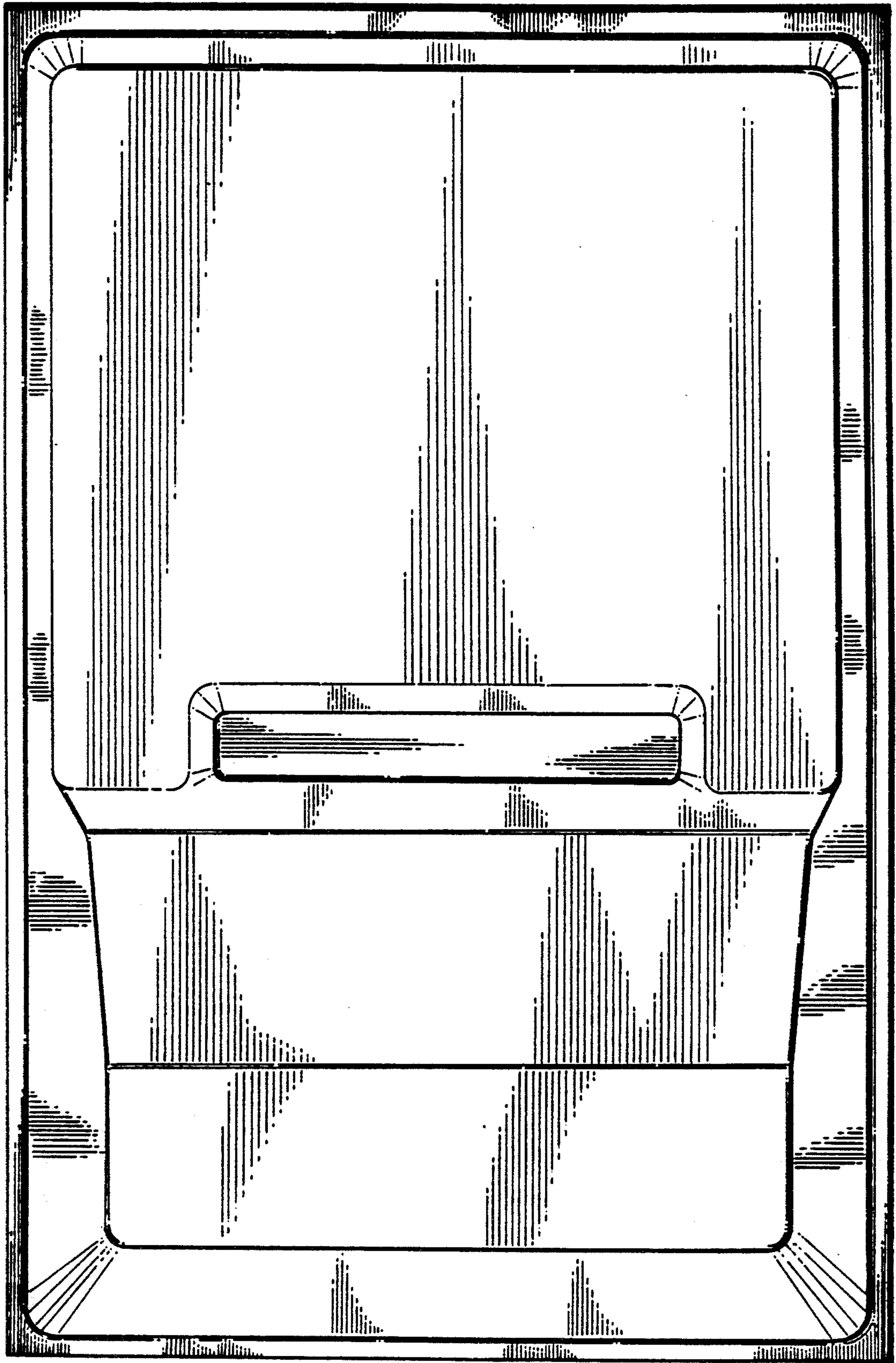

FIG. 6.