

[54] BASKETBALL HOOP AND BASKETBALL SPORTS FIGURE

[76] Inventor: Peter Nys, Watermolenstraat 20, 2958 Zemst, Belgium

[**] Term: 14 Years

[21] Appl. No.: 357,750

[22] Filed: May 26, 1989

[52] U.S. Cl. D11/157; D11/131

[58] Field of Search D11/131, 157; D21/201; D19/96, 97; 248/518, 519

[56] References Cited

U.S. PATENT DOCUMENTS

D. 59,656	11/1921	Hudson	D19/96
D. 110,225	6/1938	Schutt	D21/201
D. 299,041	12/1988	Thornell	D21/201
D. 315,185	3/1991	Maloney	D21/201
3,244,420	4/1966	Poynten	D21/201 X

OTHER PUBLICATIONS

Wallace Catalog; 1930; p. 38; Trophy V316/7 (left). Spalding Catalog; 1978; p. 52, basketball 61-241 (left).

Primary Examiner—Bernard Ansher
Assistant Examiner—Dominic Simone
Attorney, Agent, or Firm—Foley & Lardner

[57] CLAIM

The ornamental design for a basketball hoop and basketball sports figure, as shown and described.

DESCRIPTION

FIG. 1 is a front perspective view of a basketball hoop and basketball sports figure, showing my new design; FIG. 2 is a front elevational view thereof; FIG. 3 is a left side elevational view thereof; FIG. 4 is a right side elevational view thereof; FIG. 5 is a rear elevational view thereof; FIG. 6 is a top plan view thereof; and FIG. 7 is a bottom plan view thereof.

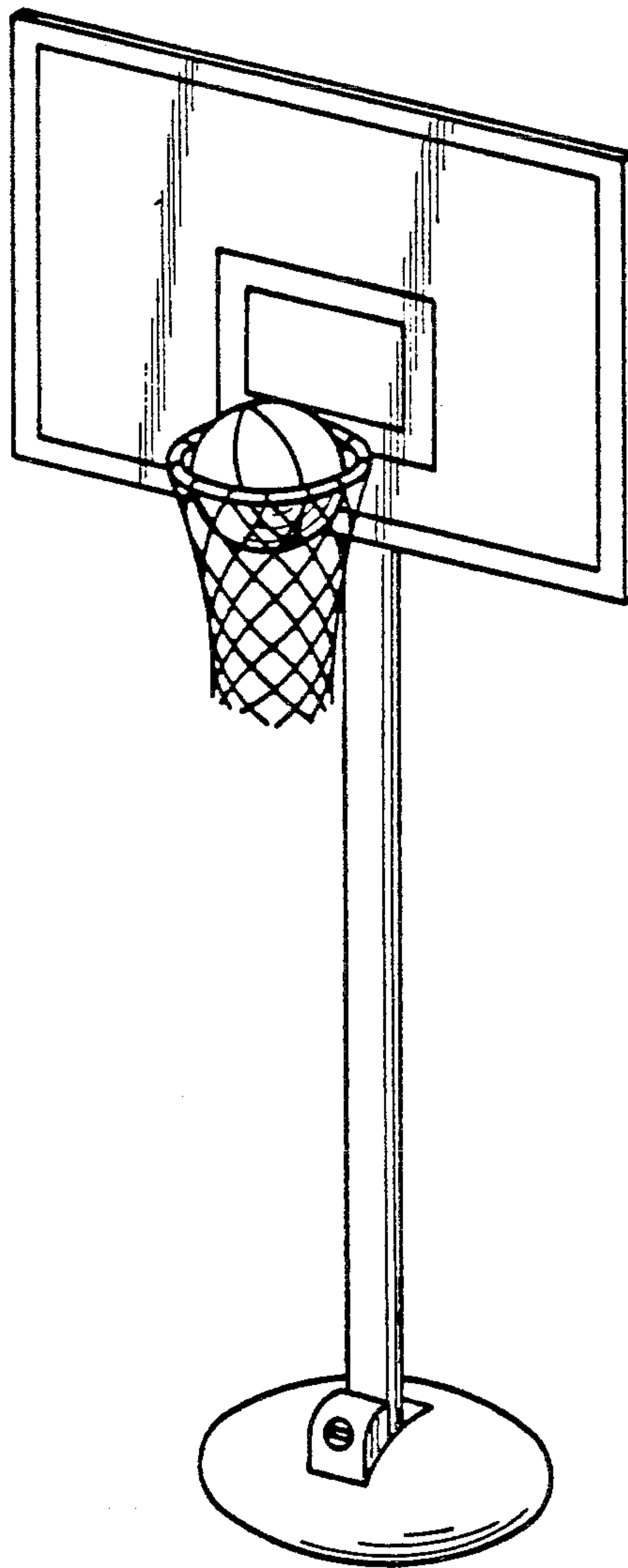

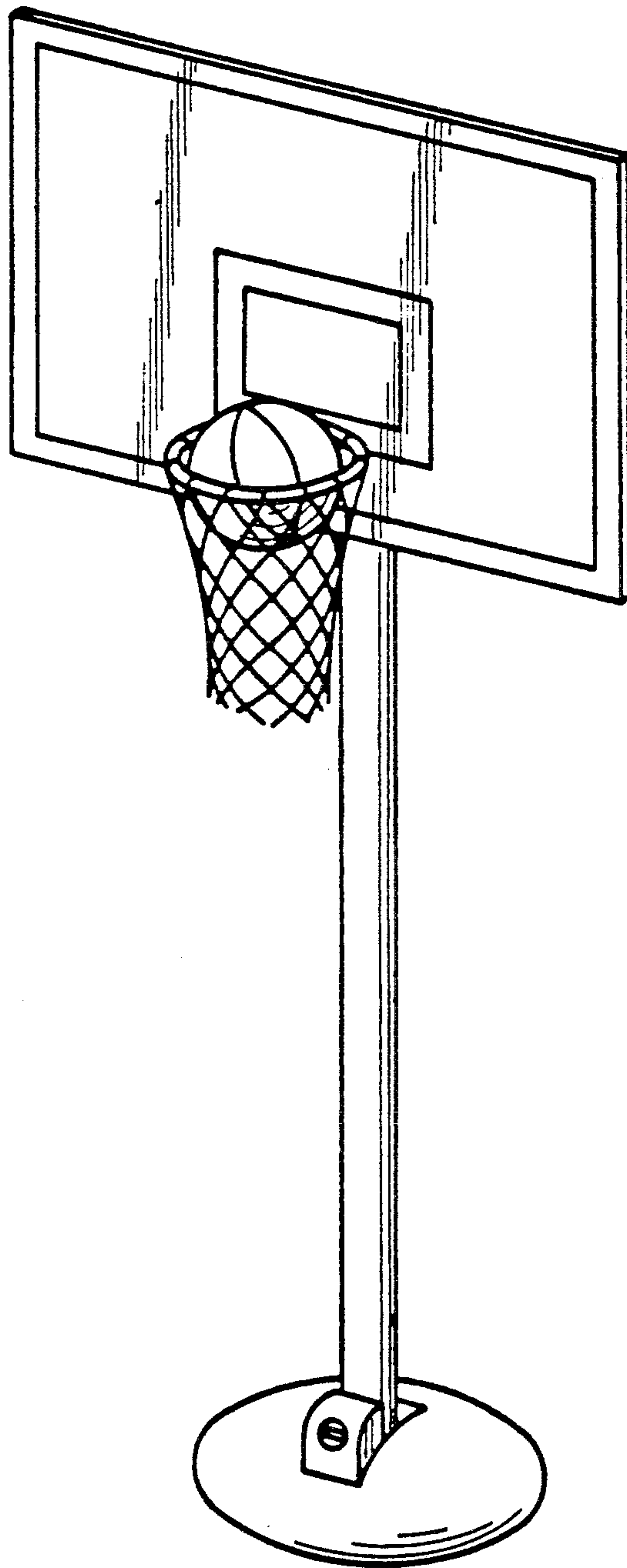

Fig. 1

Fig. 6

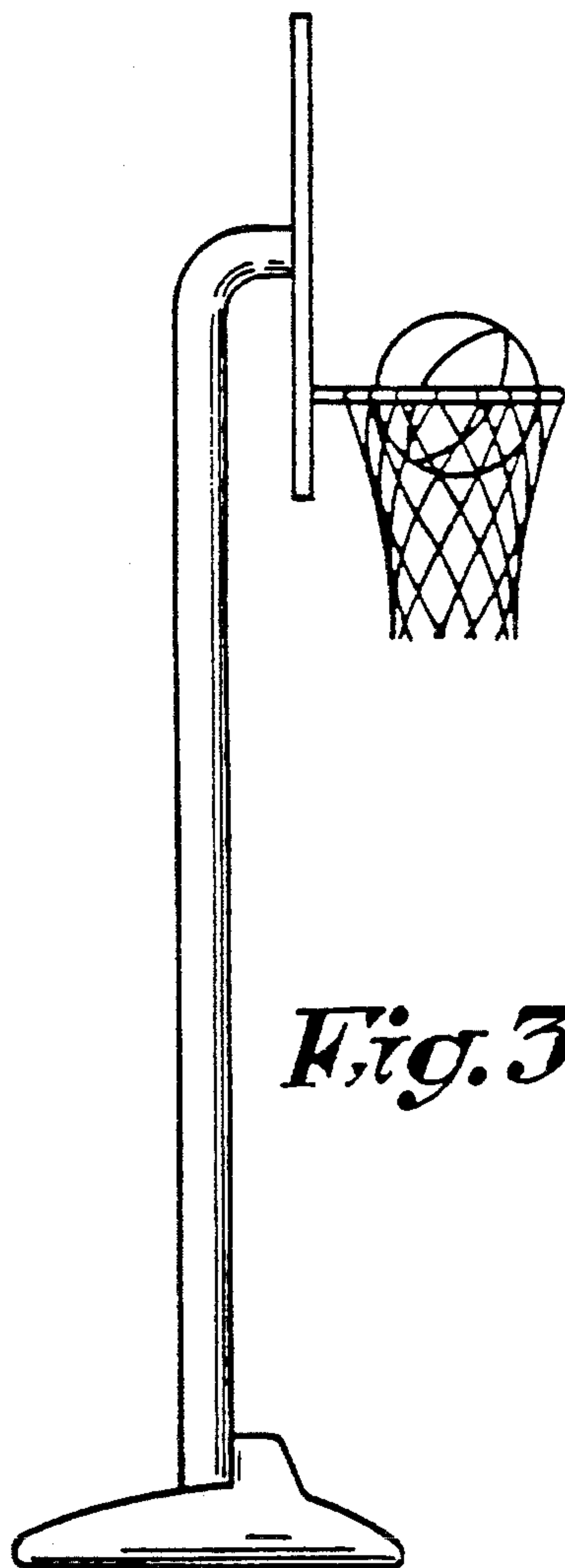
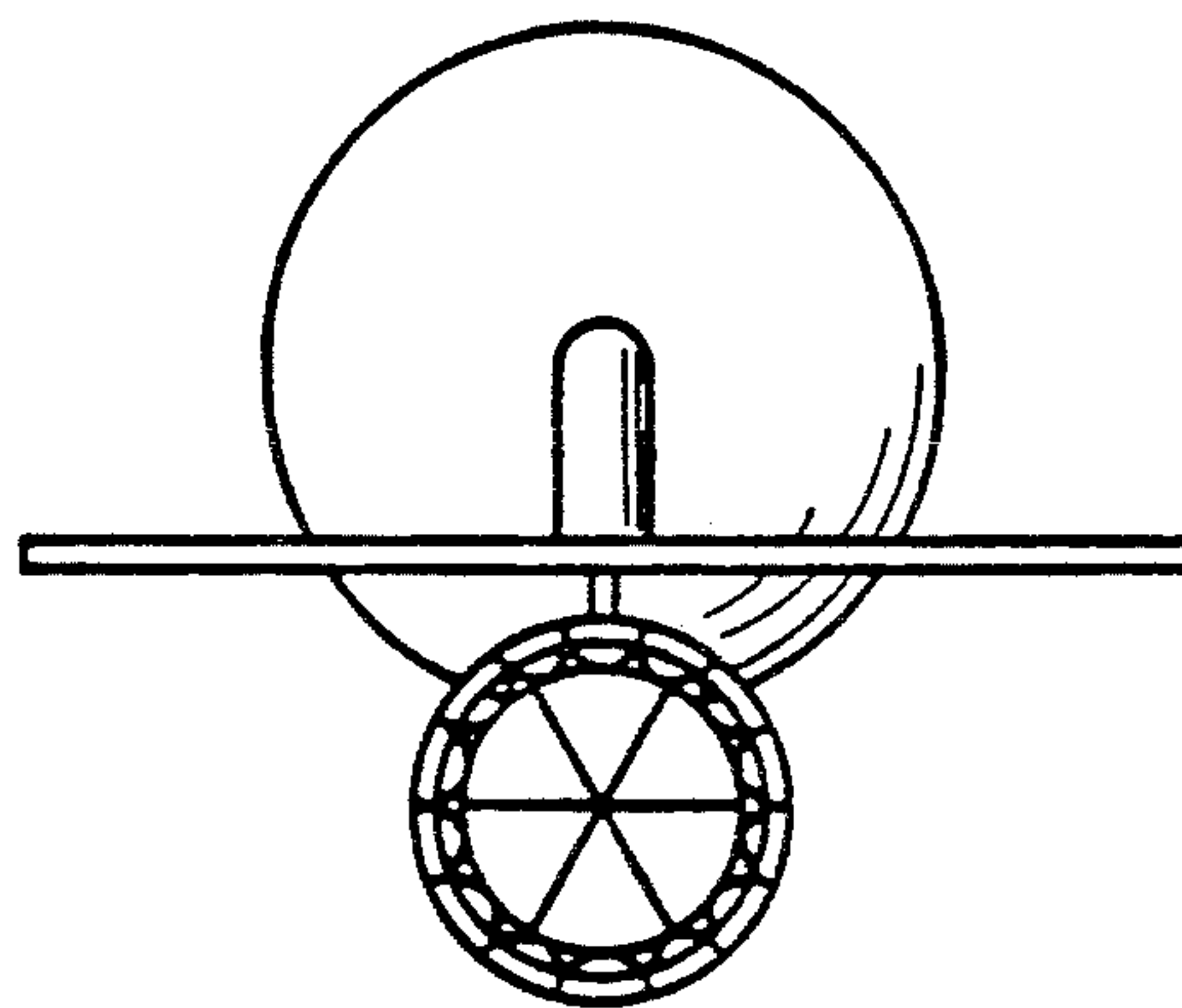

Fig. 3

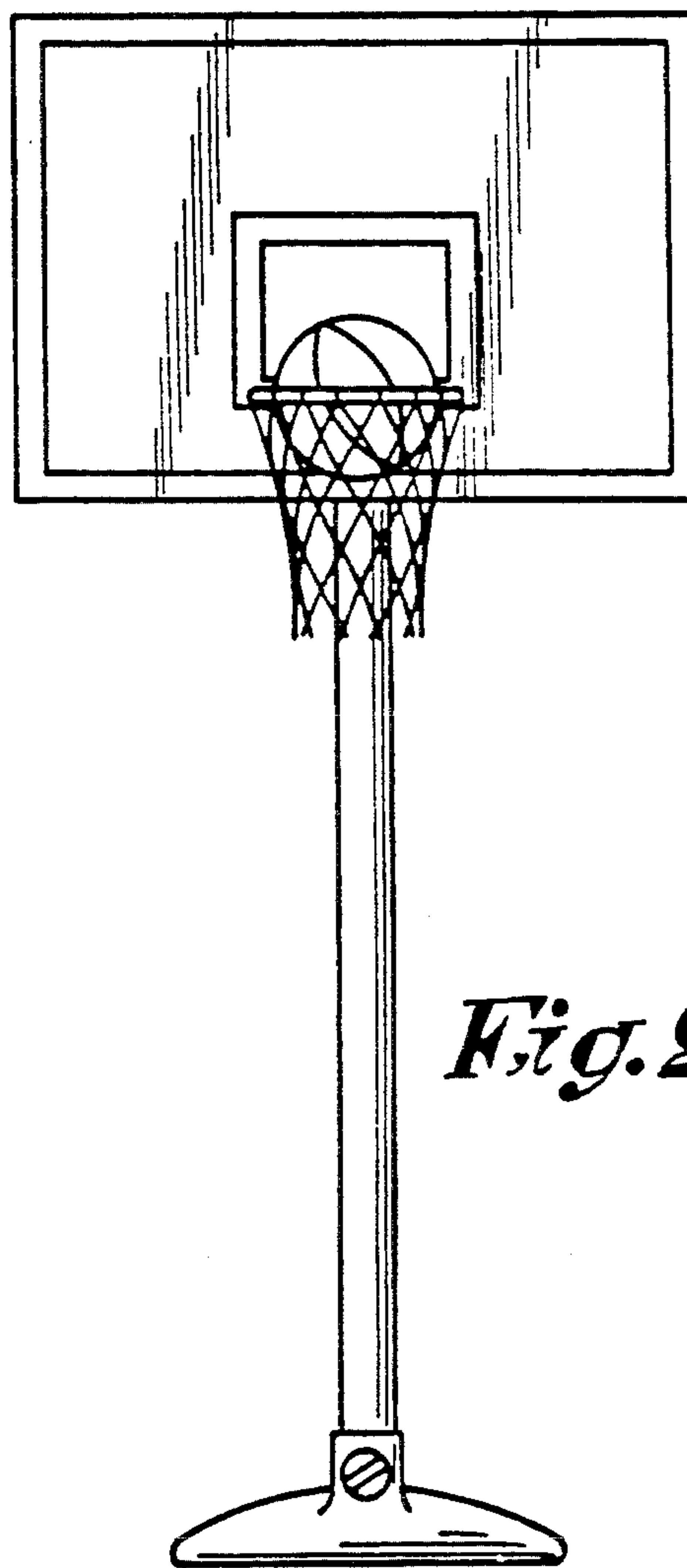
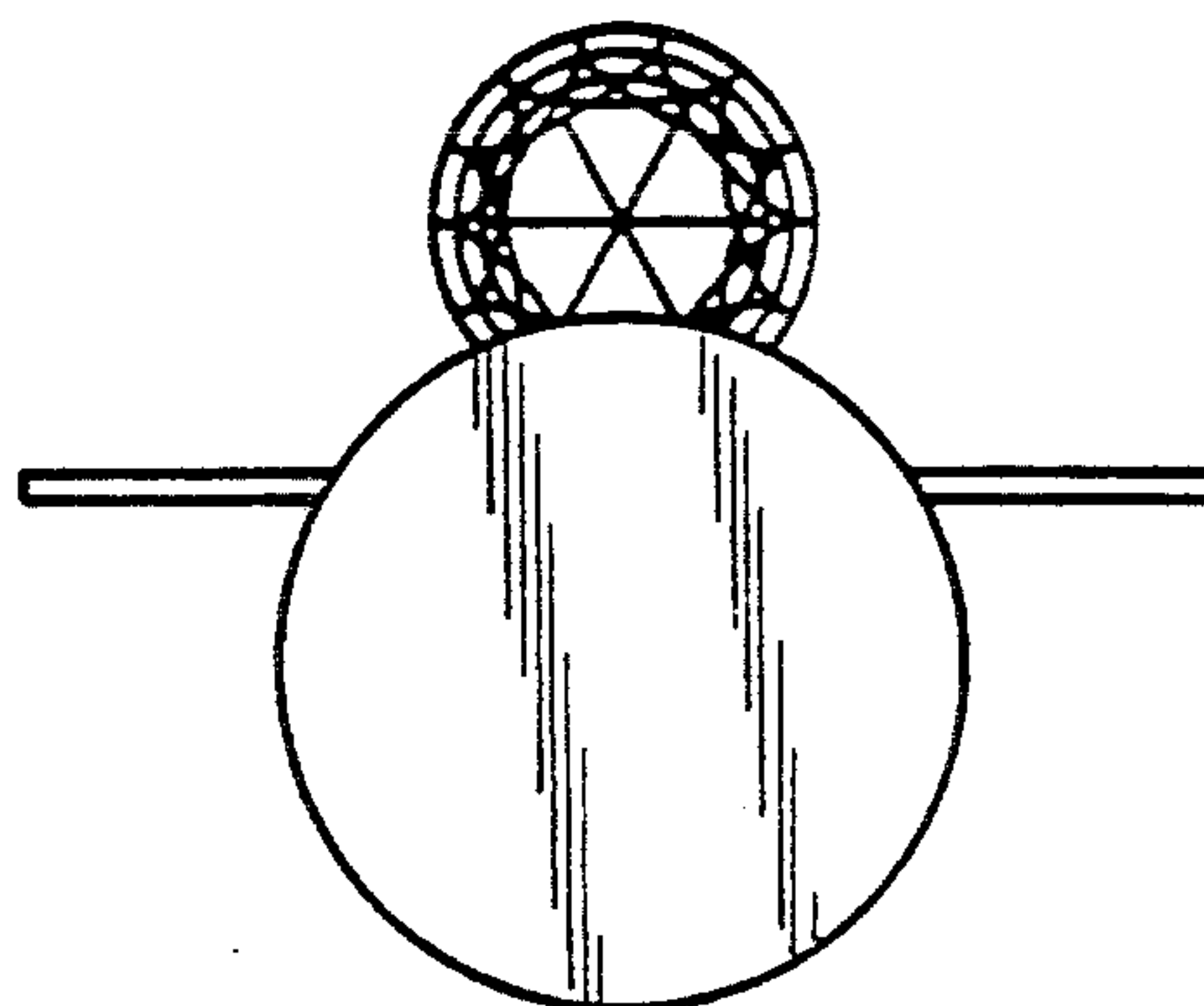

Fig. 2

Fig. 7



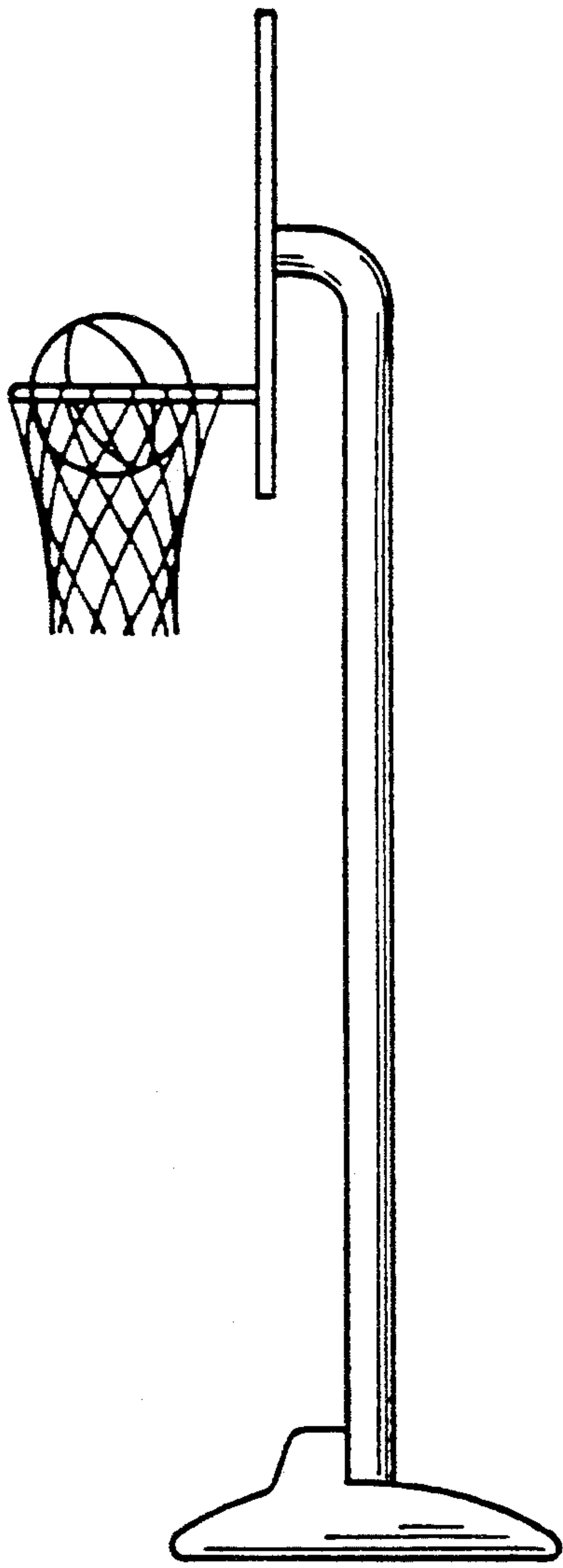

Fig. 4

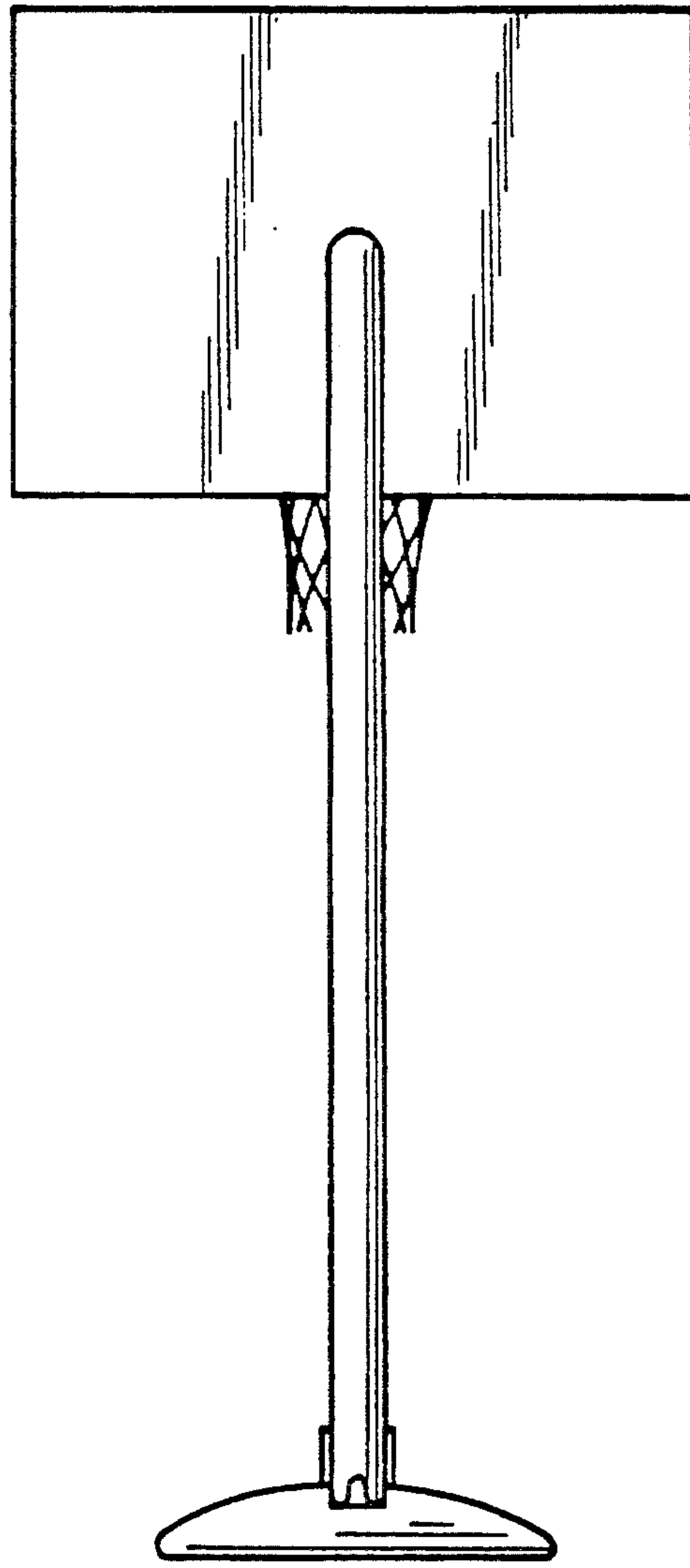

Fig. 5