

[54] TREE STAND OR SIMILAR ARTICLE

[76] Inventor: Leo Rosato, 64 Fairmile Road, R.R. #4, Kemptonville, Ontario K0G 1S0, Canada

[**] Term: 14 Years

[21] Appl. No.: 382,873

[22] Filed: Jul. 20, 1989

[30] Foreign Application Priority F

Feb. 3, 1989 [CA] Canada 0302894

[52] U.S. Cl. D11/130.1

[58] Field of Search D11/130.1; 248/519, 248/511; 47/40.5

[56] References Cited

U.S. PATENT DOCUMENTS

- D. 26,715 3/1897 Bobrick 248/519 X
- D. 79,274 8/1929 Larochi D11/130.1
- D. 287,476 12/1986 Craft et al. D11/130.1
- 1,846,891 2/1932 Miller .
- 1,856,000 4/1932 Smith 47/40.5
- 2,044,192 6/1936 Templin, Jr. .
- 2,652,217 9/1953 Schulz .
- 2,701,699 2/1955 Chapin .
- 2,733,032 1/1956 Farley et al. .
- 2,815,908 12/1957 Scanland .

- 2,978,780 4/1961 Clarkson .
- 2,980,377 4/1961 Nielson et al. .
- 2,994,498 8/1961 Sager .
- 3,729,906 5/1973 Coblenz .
- 4,034,505 7/1977 Lydall .
- 4,130,965 12/1978 Patton et al. .
- 4,156,323 5/1979 Scheffler .
- 4,286,409 9/1981 Taylor et al. .
- 4,496,129 1/1985 Waterman et al. .
- 4,571,881 2/1986 Lathim .

Primary Examiner—Bernard Ansher
Assistant Examiner—Dominic Simone
Attorney, Agent, or Firm—Rogers & Scott

[57] CLAIM

The ornamental design for a tree stand or similar article, as shown and described.

DESCRIPTION

FIG. 1 is a top perspective view of a tree stand or similar article showing my new design;
FIG. 2 is a bottom perspective view thereof;
FIG. 3 is a top plan view thereof;
FIG. 4 is a top perspective view of a second embodiment of FIG. 1;
FIG. 5 is a bottom perspective view of FIG. 4.

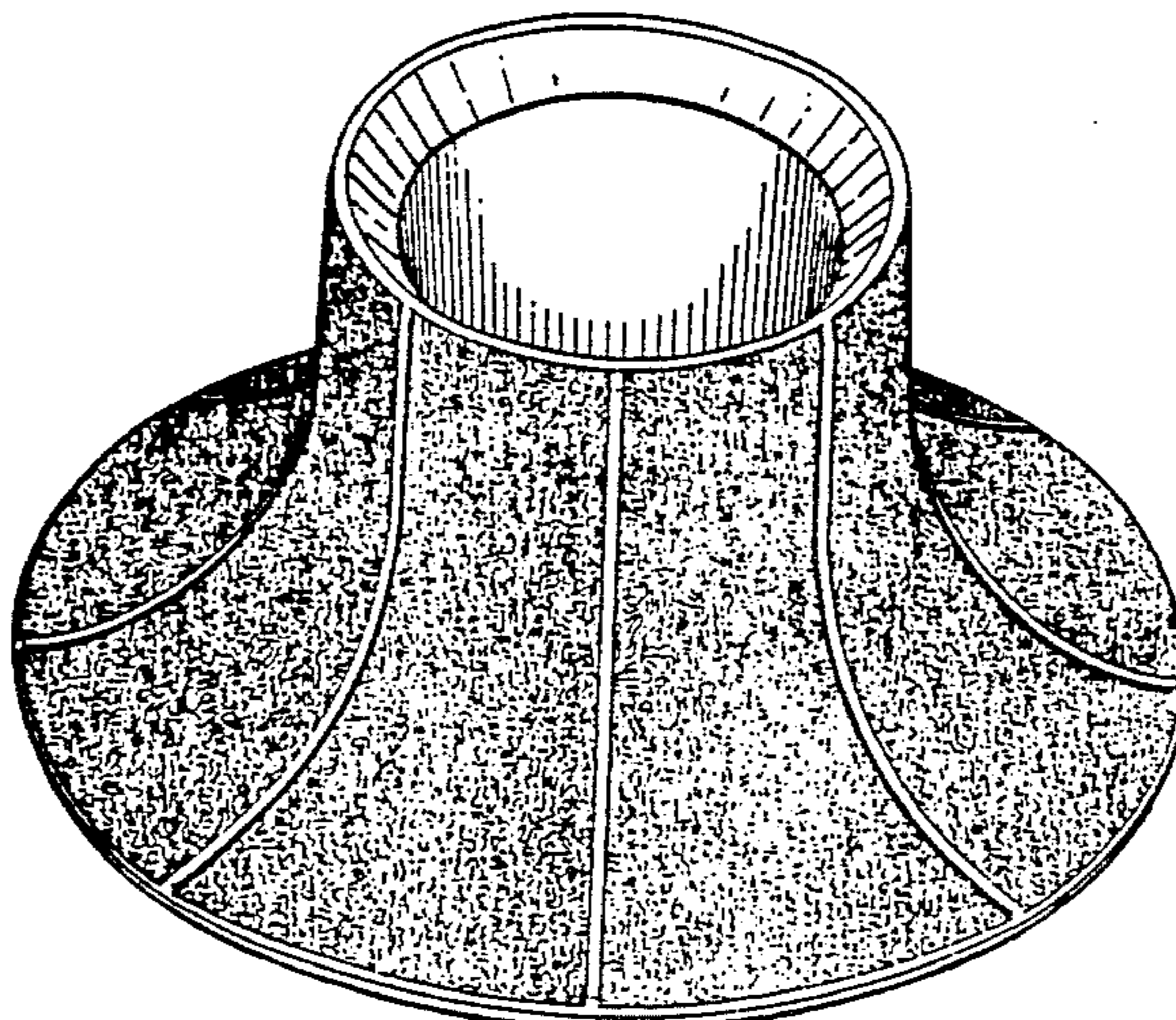
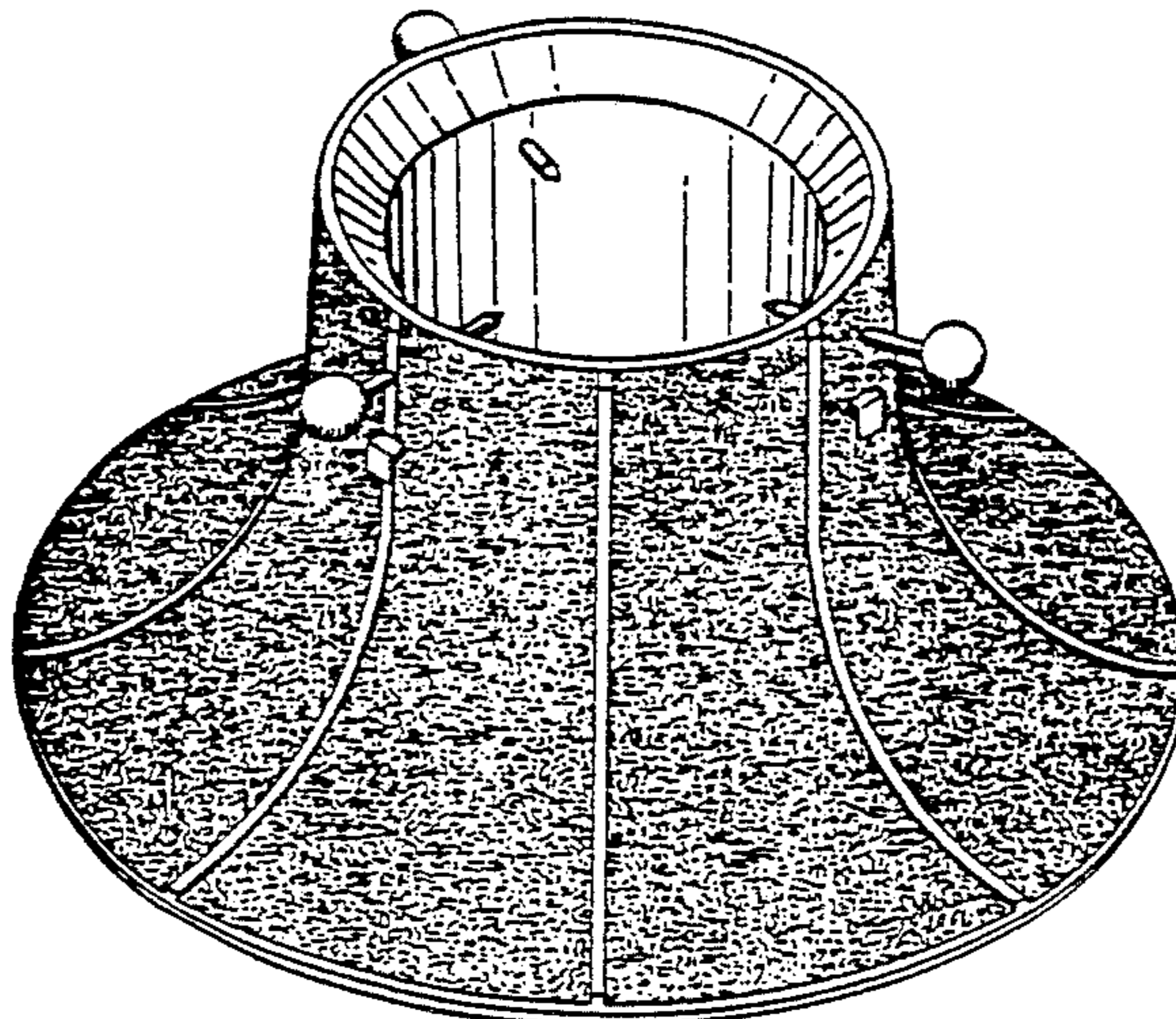

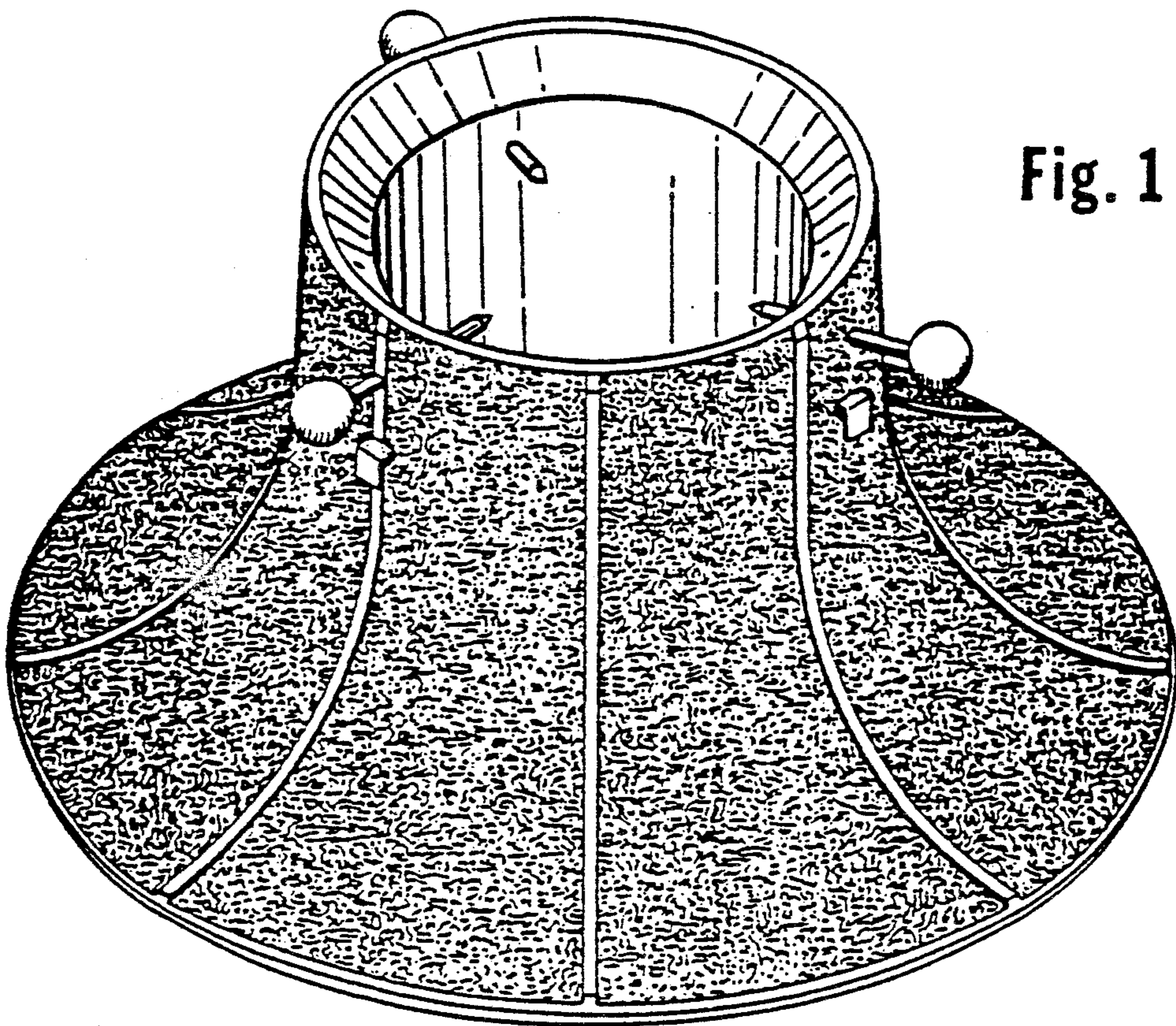

Fig. 1

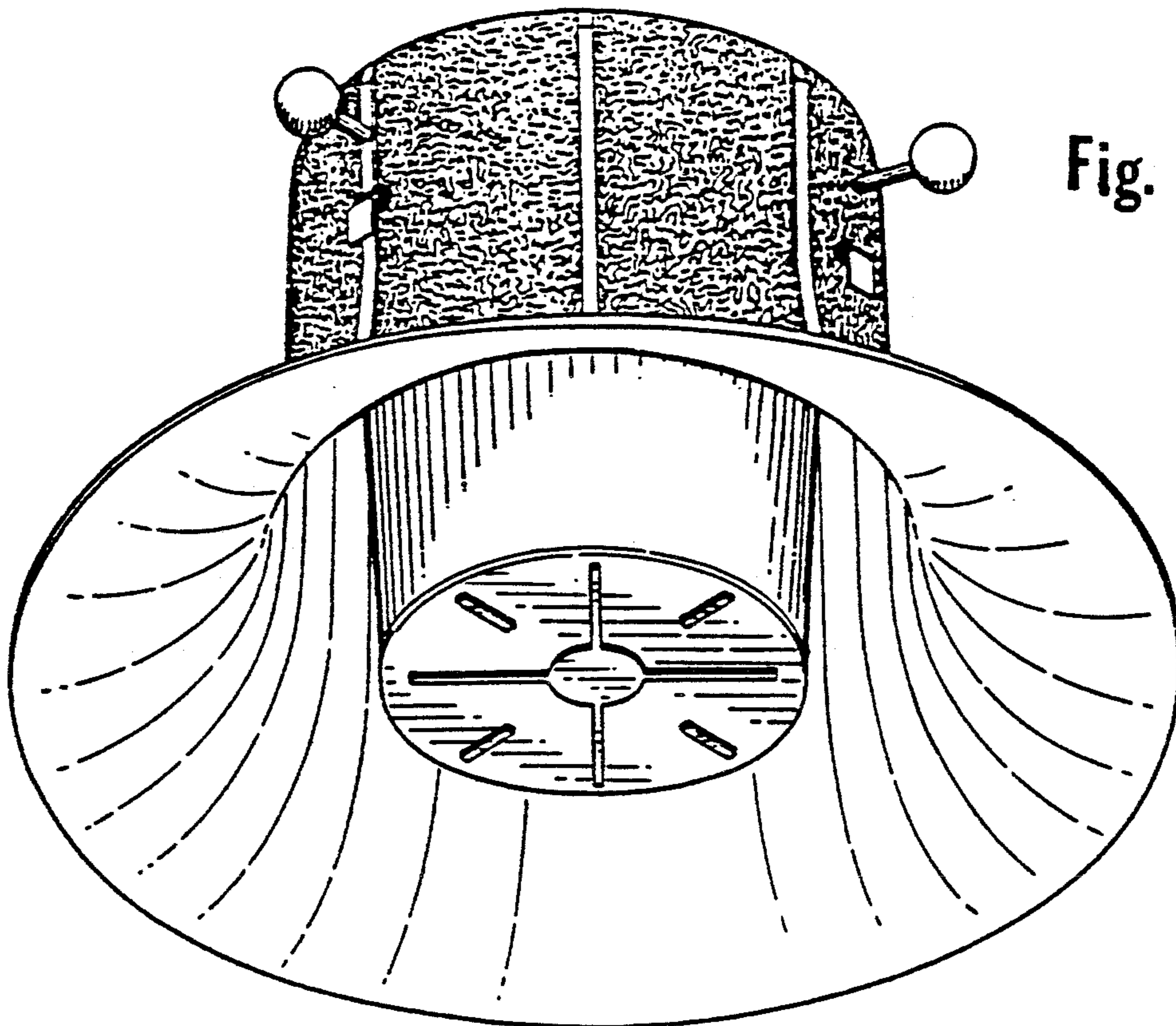

Fig. 2

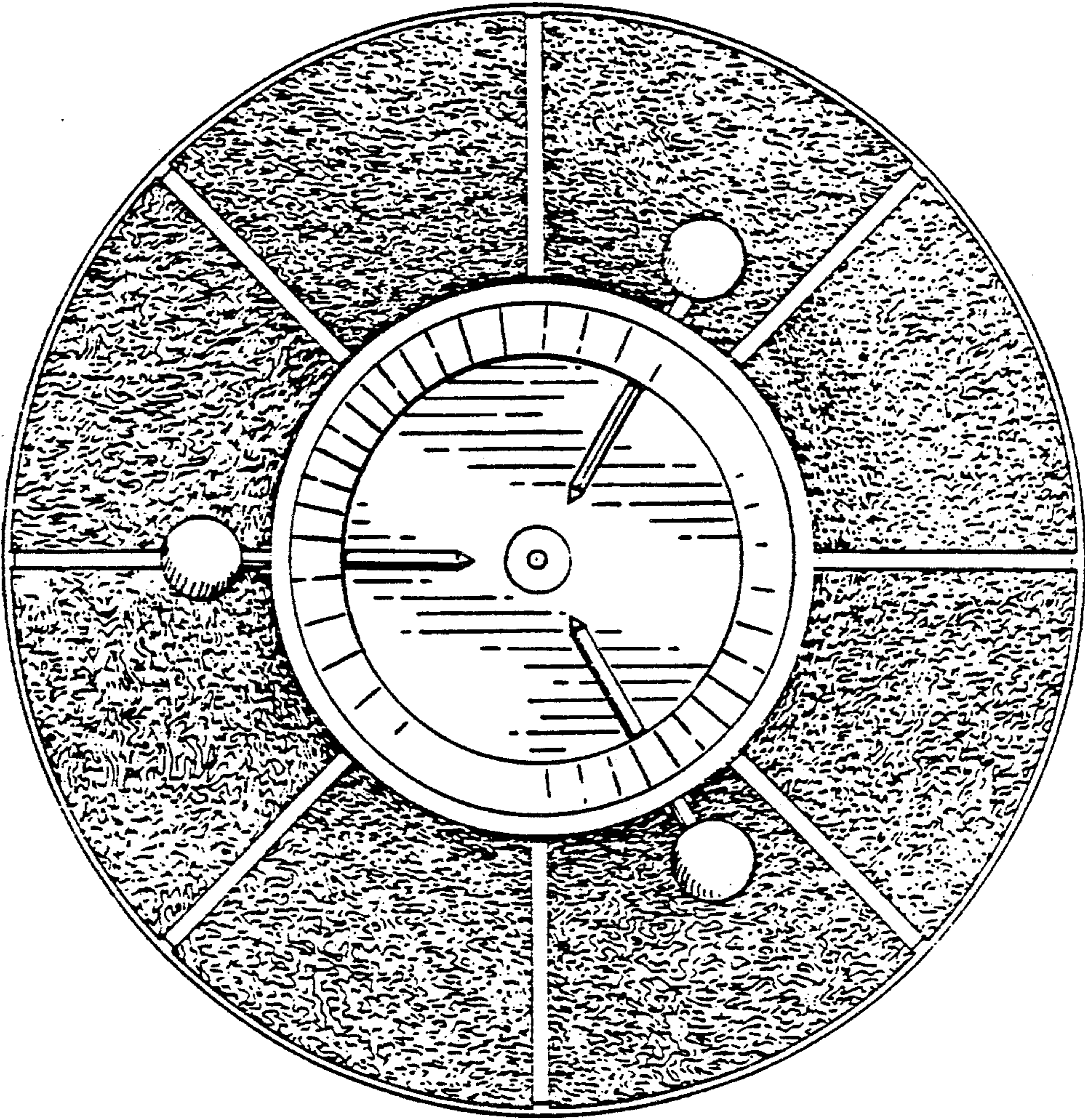

Fig. 3

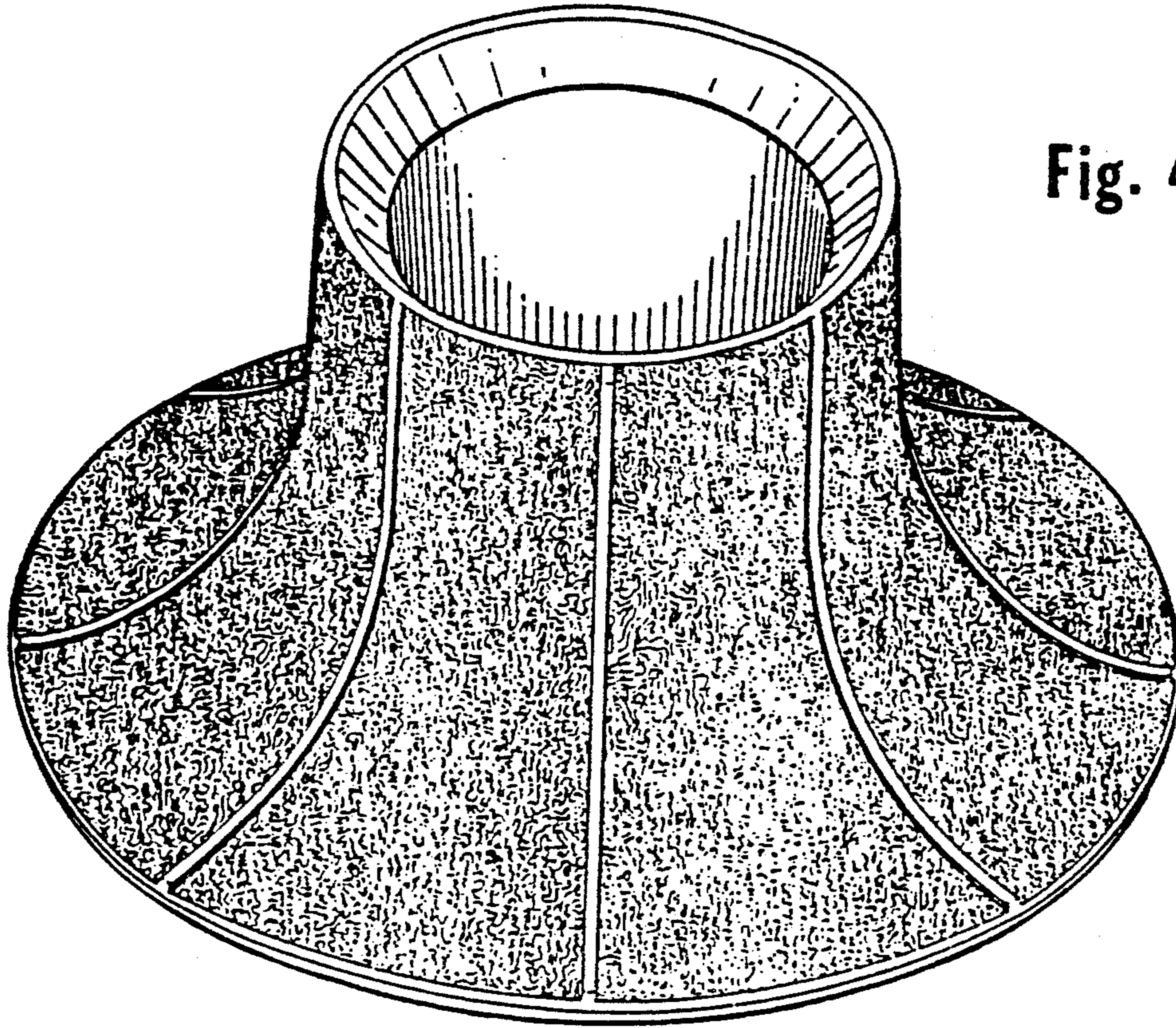

Fig. 4

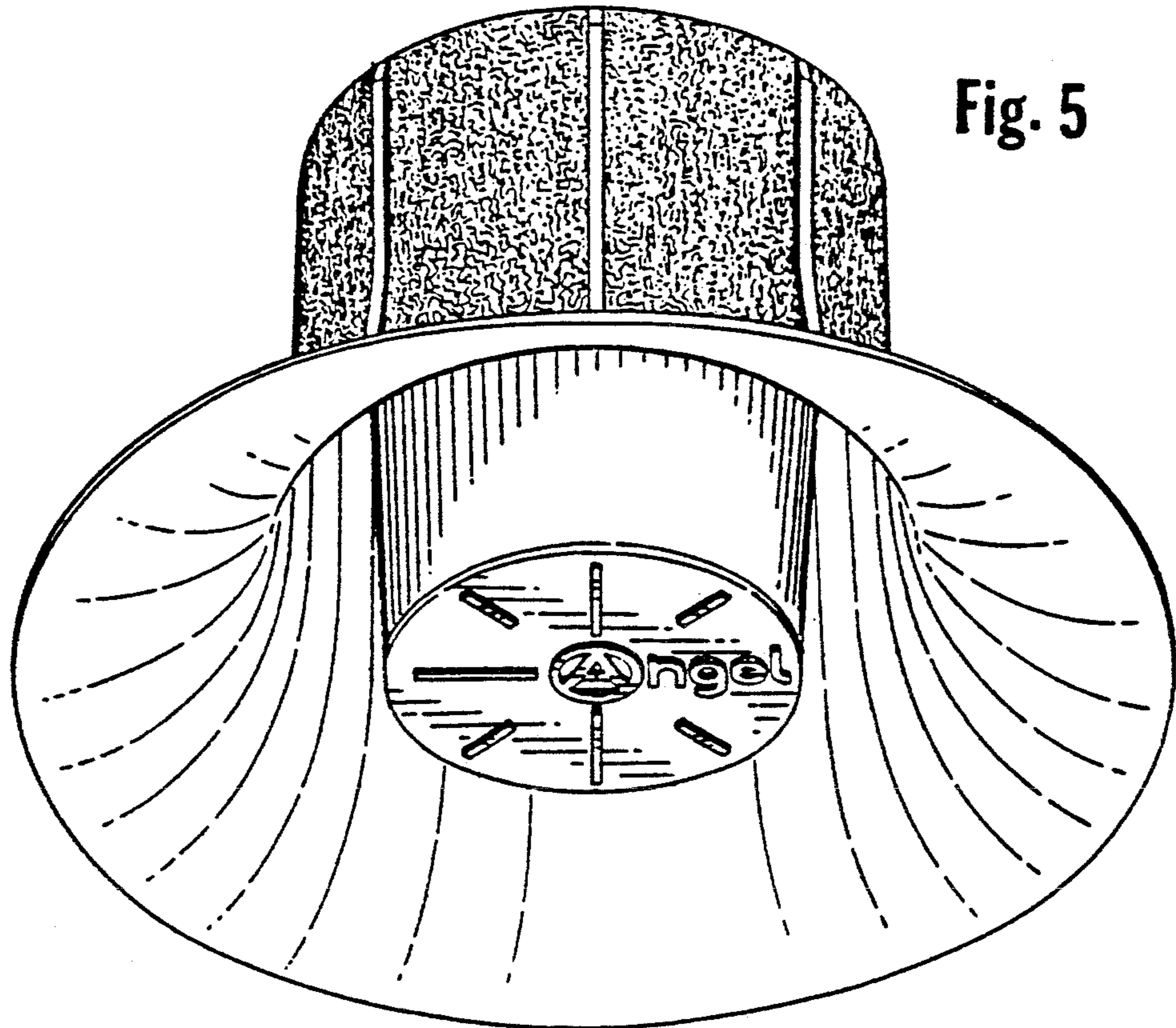

Fig. 5