

[54] GAME CONTROL HOLDER

[76] Inventor: David C. Urbanski, 1794 Covington La., Eagan, Minn. 55126

[**] Term: 14 Years

[21] Appl. No.: 421,722

[22] Filed: Oct. 16, 1989

[52] U.S. Cl. D21/48

[58] Field of Search D21/13, 48, 142, 54;
273/148 B, DIG. 28, 1 E, 85 G; D6/466, 406

[56] References Cited

U.S. PATENT DOCUMENTS

D. 272,835	2/1984	Lichae	D21/48
D. 281,515	11/1985	Klawitter	D21/48
D. 281,657	12/1985	Roczey	D6/406
D. 289,836	5/1987	Leavitt	D6/466
4,530,504	7/1985	Long, Jr.	273/148 B
4,870,389	9/1989	Ishiwata et al.	273/148 B X

OTHER PUBLICATIONS

Hong Kong Enterprise 4/1984, p. 74, bottom left of the page (in electronic games box).

Primary Examiner—Bernard Ansher
Assistant Examiner—Prabhakar Deshmukh
Attorney, Agent, or Firm—Anthony G. Eggink

[57] CLAIM

The ornamental design for a game control holder, as shown and described.

DESCRIPTION

FIG. 1 is a perspective view of a game control holder showing my new design, the broken lines showing a game control are environmental only and form no part of the claimed design;

FIG. 2 is a bottom plan view thereof;

FIG. 3 is a top plan view thereof;

FIG. 4 is a front elevation thereof;

FIG. 5 is a left side elevation thereof;

FIG. 6 is a rear elevation of alternate embodiment of FIG. 1; and

FIG. 7 is a right elevation of FIG. 1.

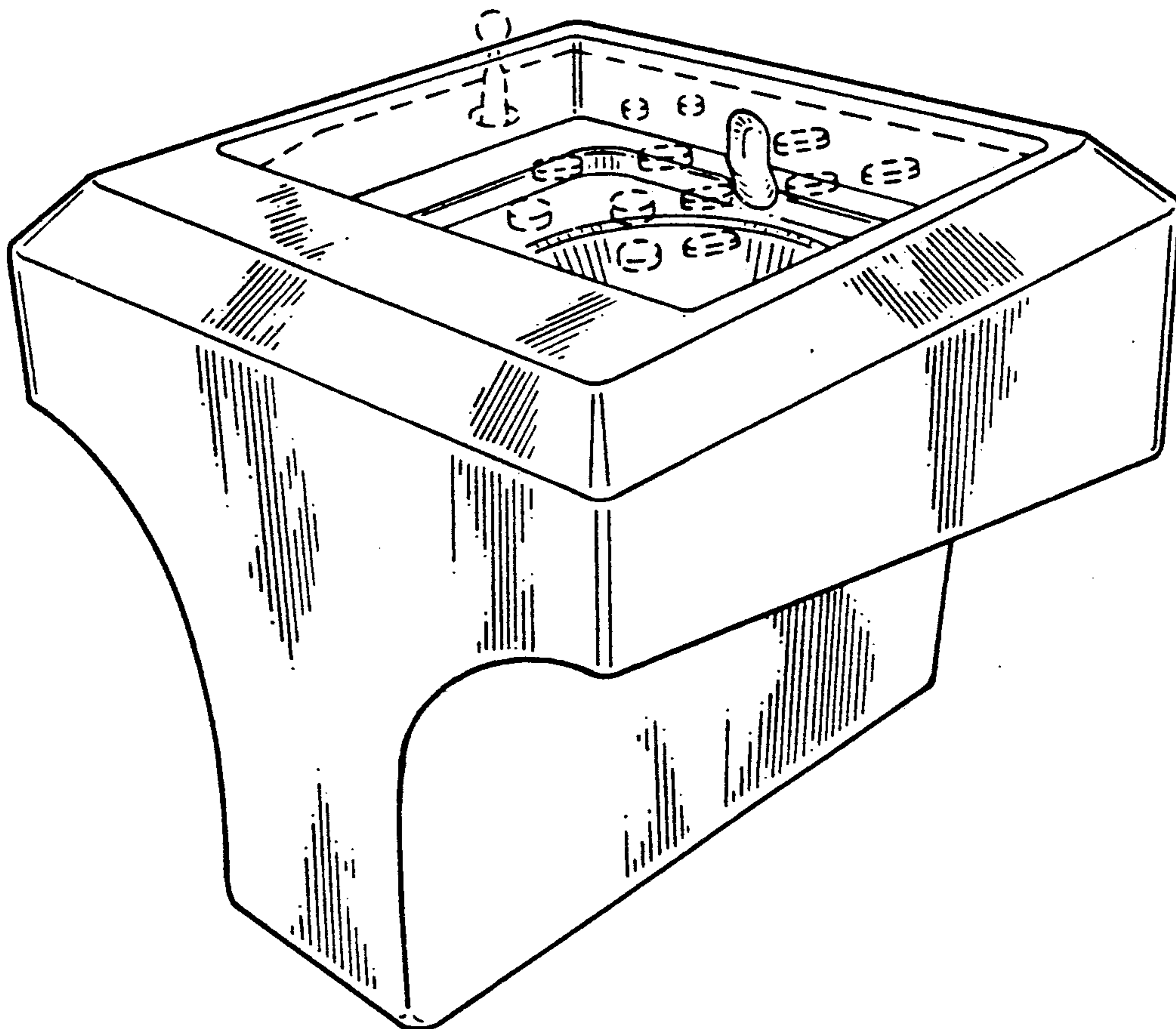

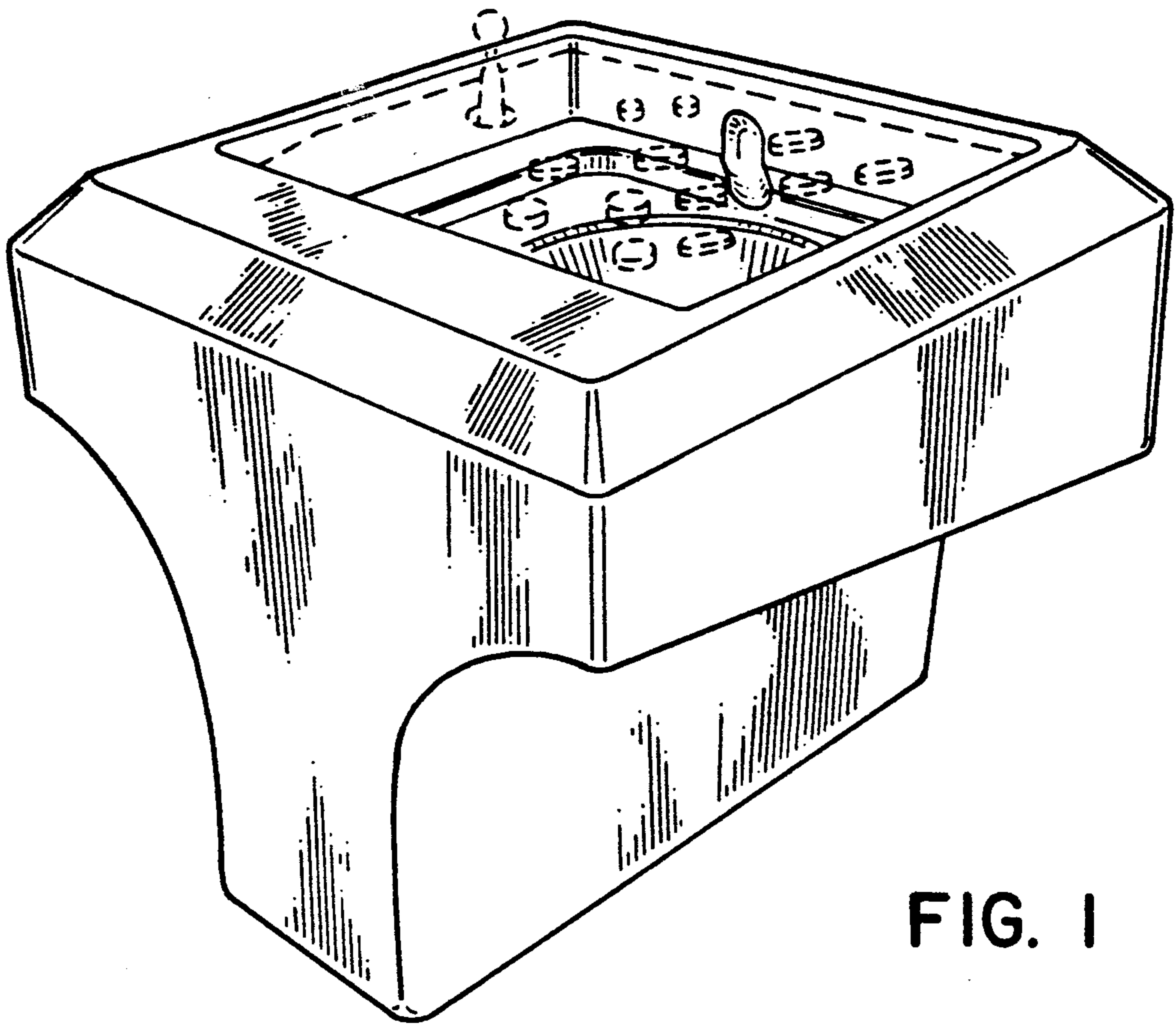

FIG. 1

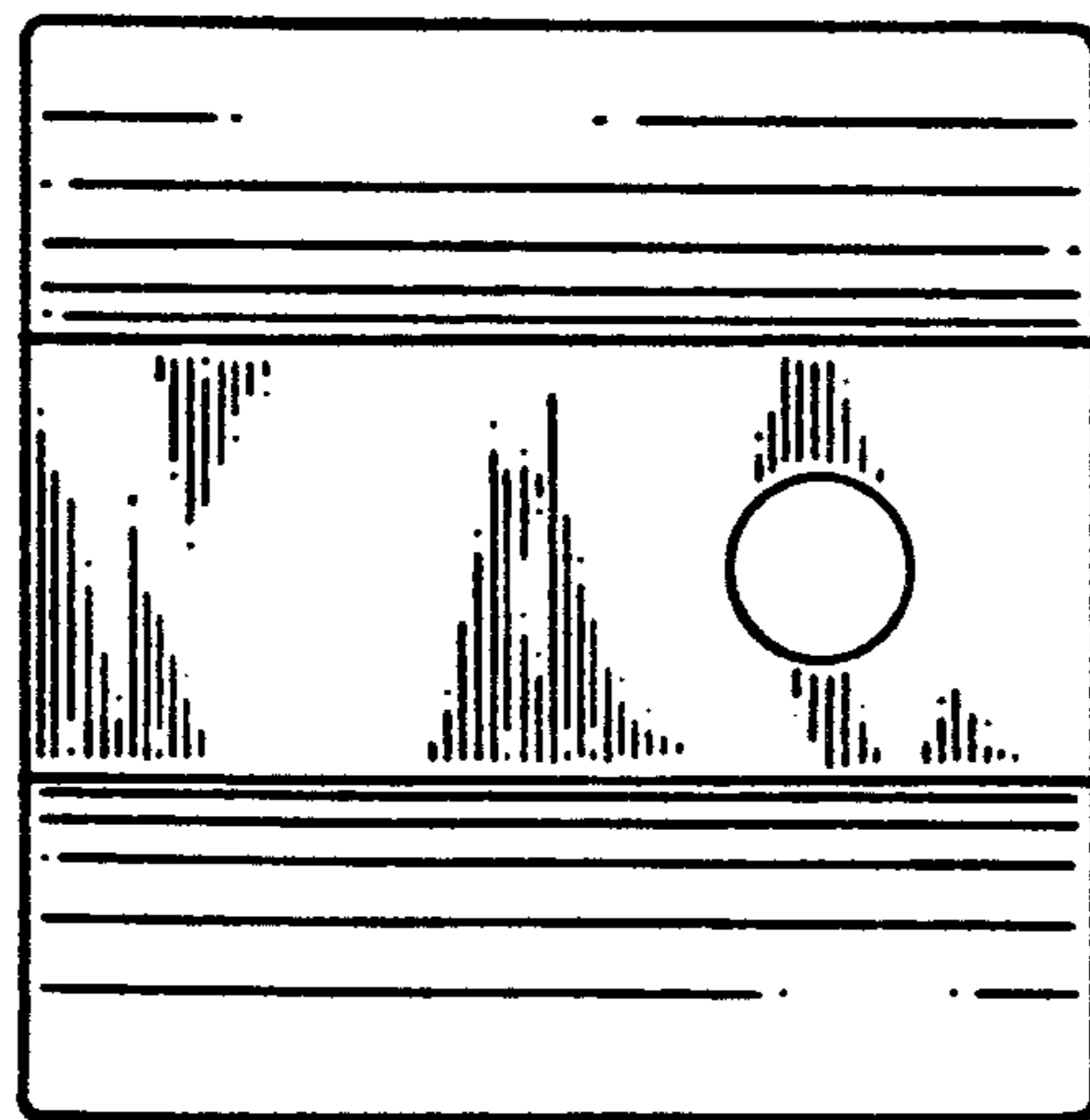

FIG. 2

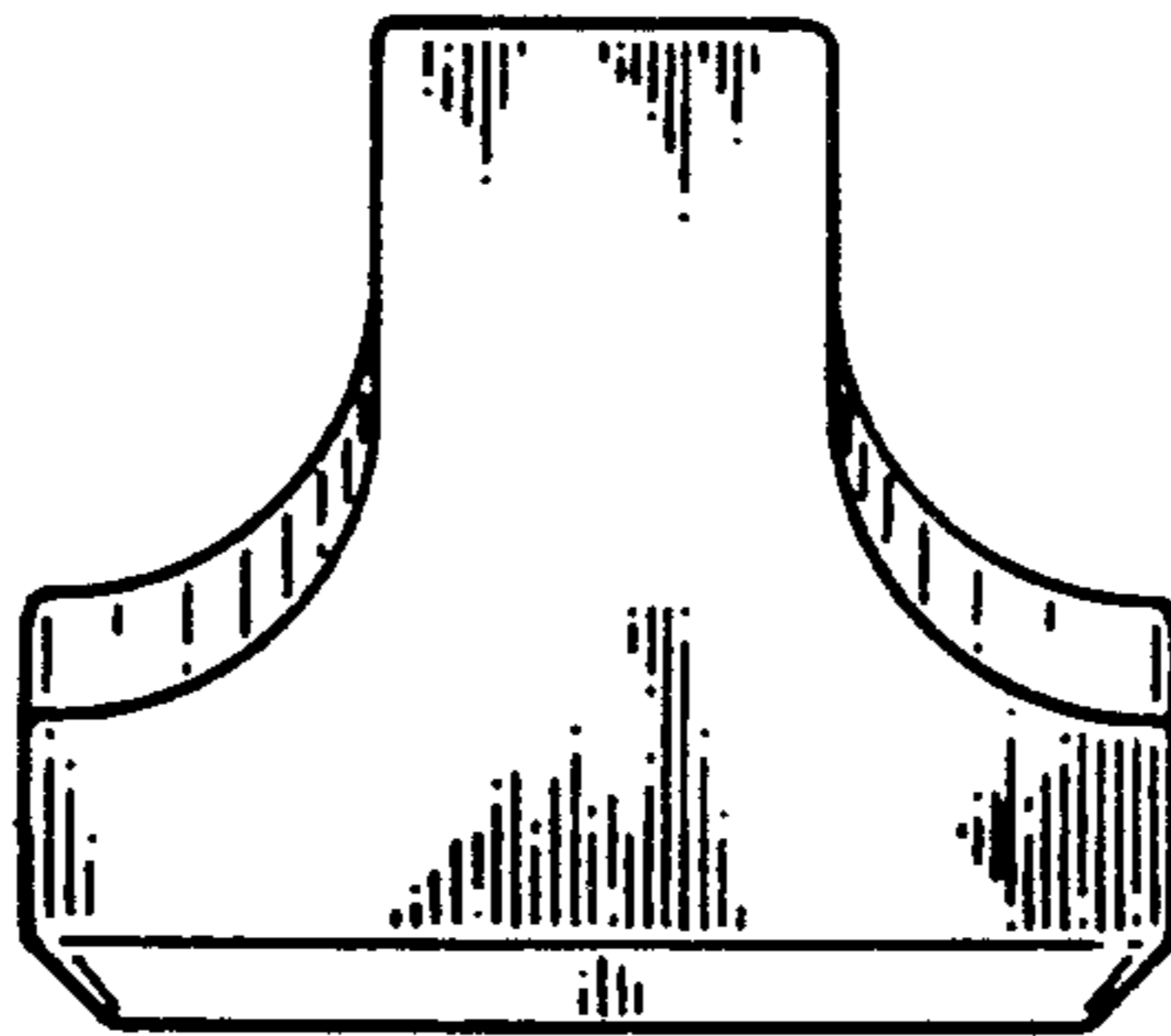

FIG. 4

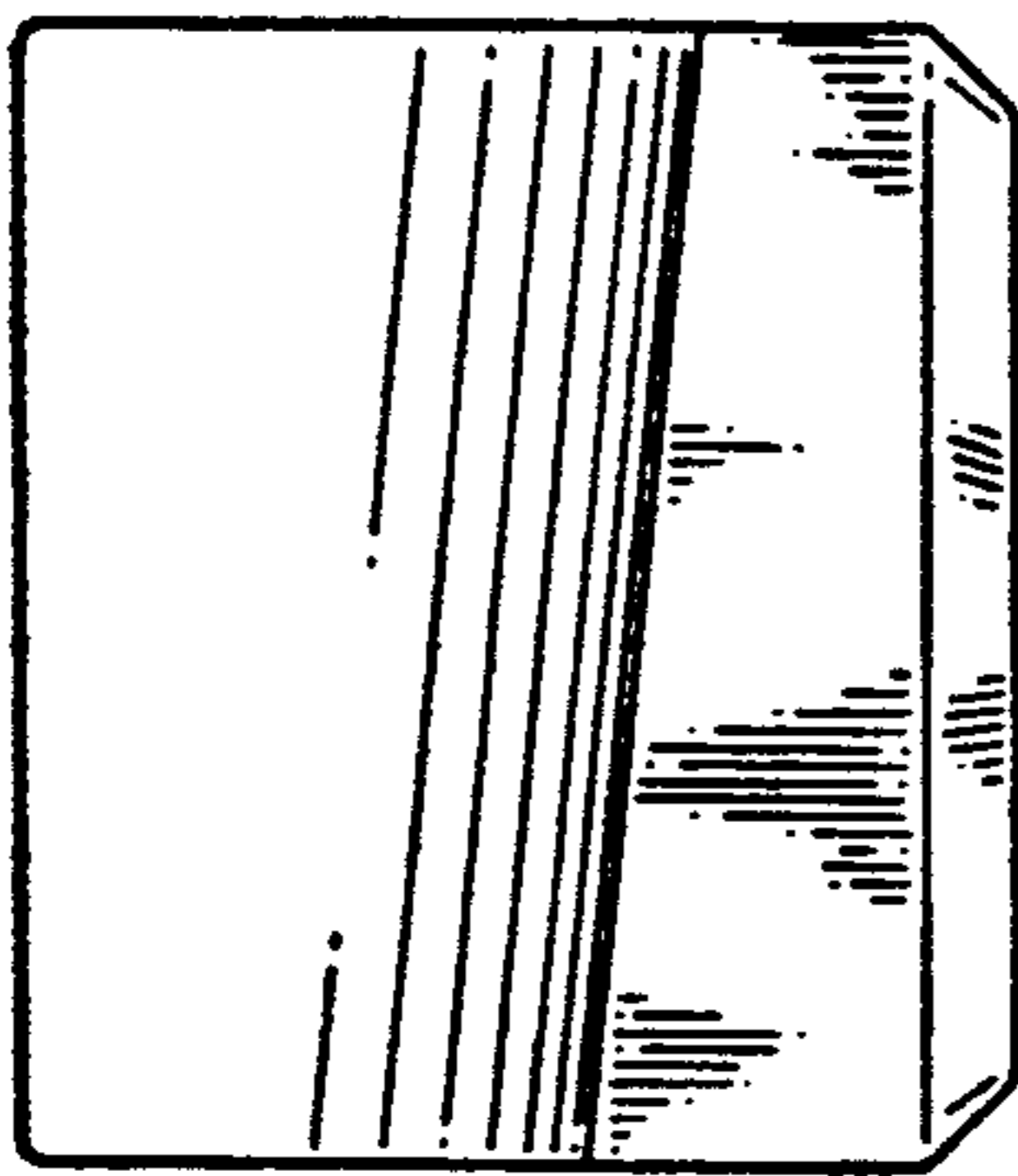

FIG. 7

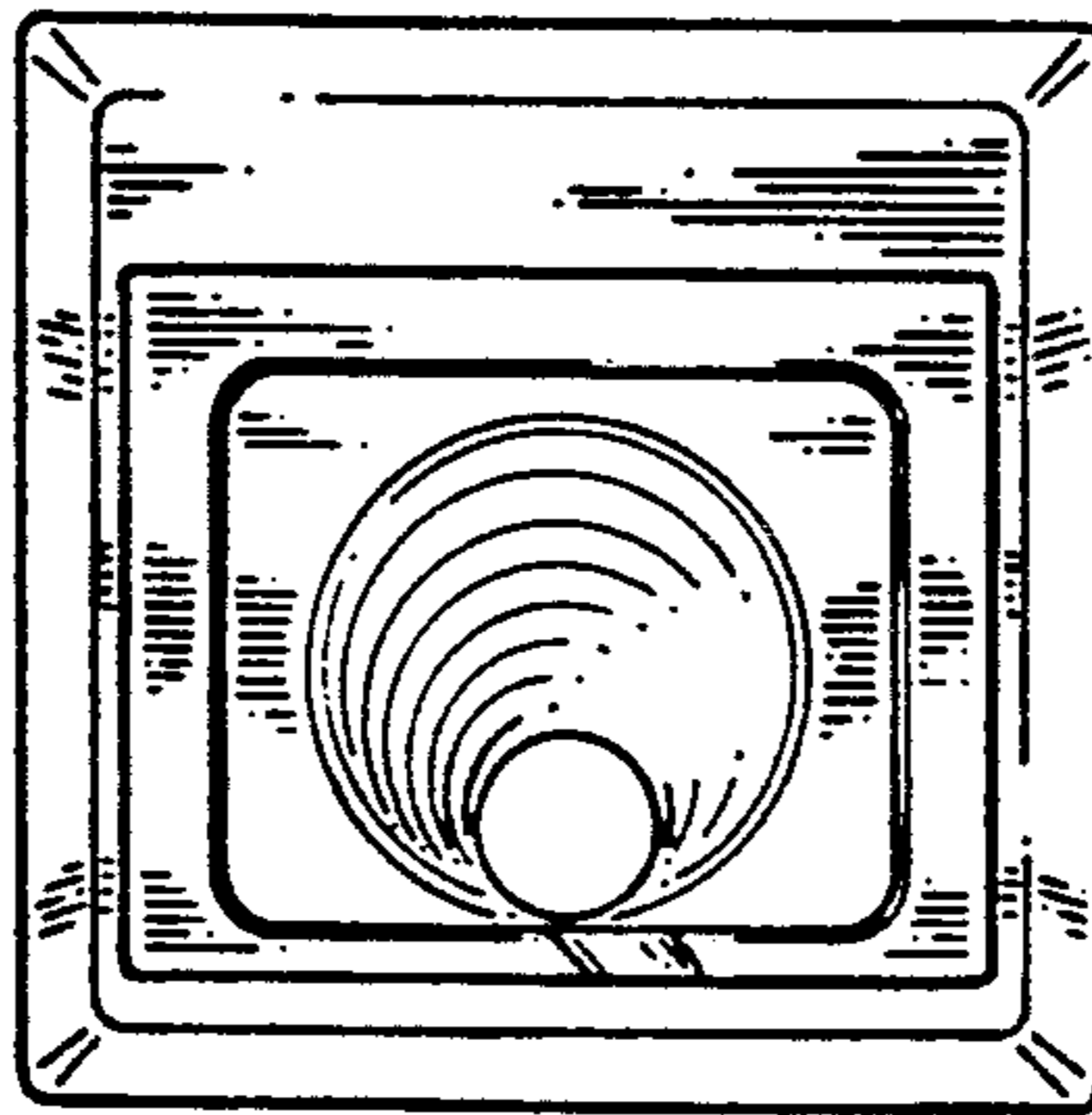

FIG. 3

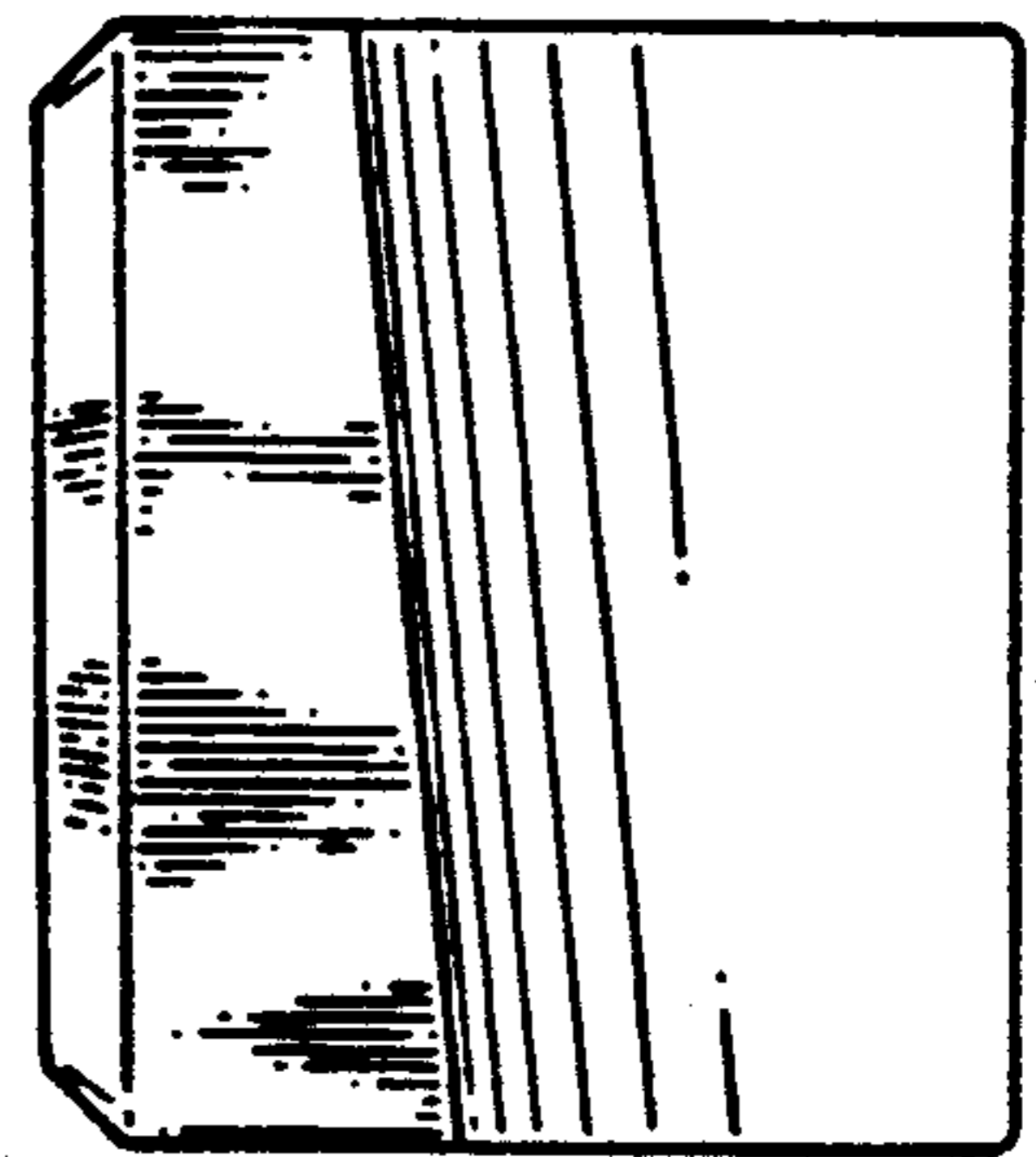

FIG. 5

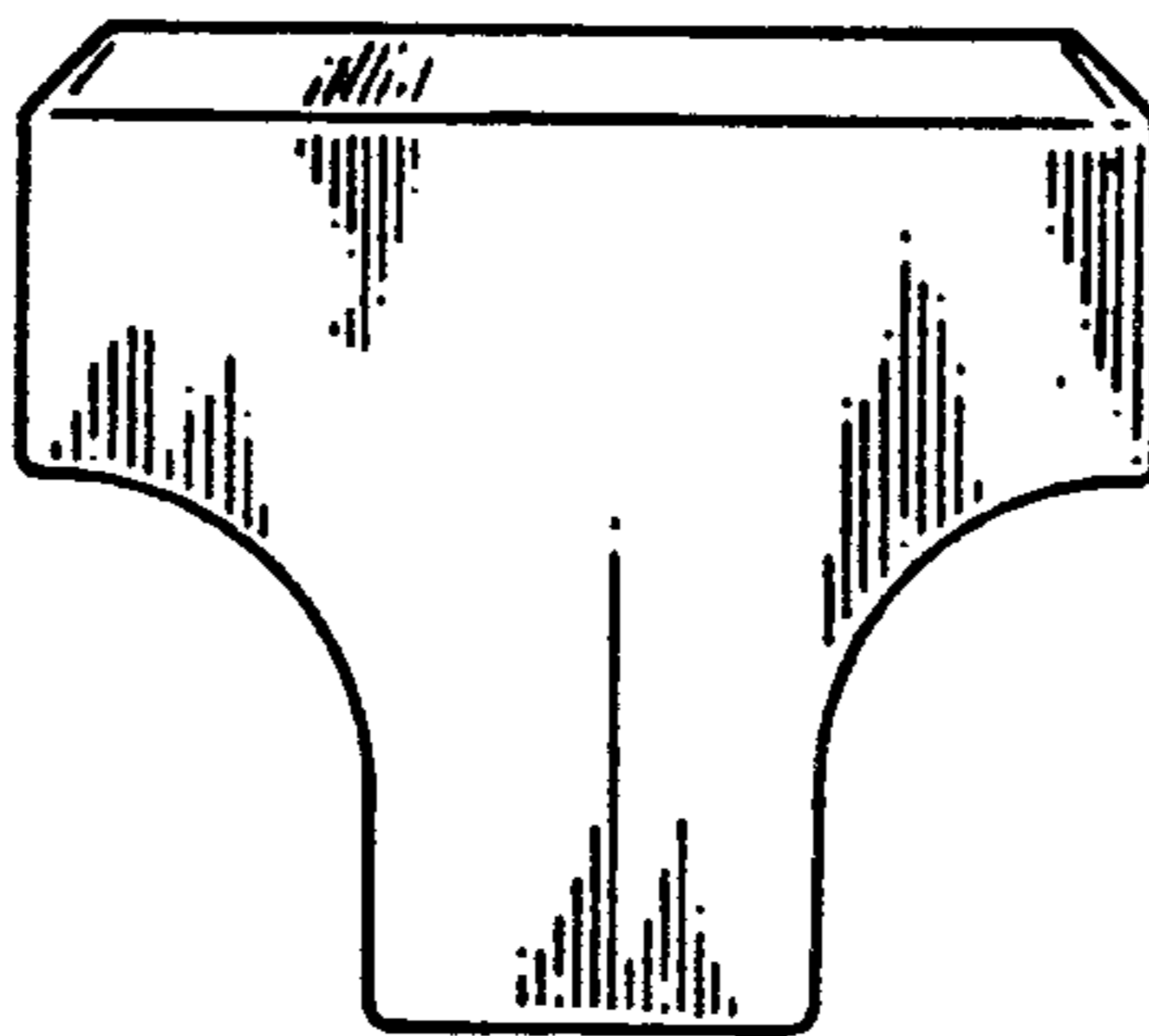

FIG. 6