

[54] CONTAINER FOR CONFECTIONERY PRODUCTS

[75] Inventor: Pietro Ferrero, Brussels, Belgium

[73] Assignee: Ferrero Ardennes S.A., Arlon, Belgium

[\*\*] Term: 14 Years

[21] Appl. No.: 479,554

[22] Filed: Feb. 13, 1990

[30] Foreign Application Priority Data

Sep. 29, 1989 [IT] Italy ..... 53387-B/89

[52] U.S. Cl. .... D9/318

[58] Field of Search ..... D9/307, 310, 318;  
 D7/516, 595, 599, 613, 628; D3/66, 44;  
 D21/148, 161, 186; D99/38, 40; D11/158;  
 D1/110

[56] References Cited

U.S. PATENT DOCUMENTS

- D. 151,633 11/1948 Graboi ..... D21/161 X
- D. 217,174 4/1970 Northup ..... D21/186 X
- D. 261,914 11/1981 Marconi ..... D21/161
- D. 266,938 11/1982 Barton ..... D21/148
- D. 267,283 12/1982 Nagode ..... D99/40
- D. 287,334 12/1986 Ferrero ..... D9/318

Primary Examiner—Bernard Ansher

Assistant Examiner—C. Tuttle

Attorney, Agent, or Firm—Rothwell, Figg, Ernst & Kurz

[57] CLAIM

The ornamental design for a container for confectionery products, as shown.

DESCRIPTION

FIG. 1 is a front elevational view of a container for confectionery products showing my new design;

FIG. 2 is a right side elevational view thereof;

FIG. 3 is a rear elevational view thereof;

FIG. 4 is a bottom plan view thereof;

FIG. 5 is a left side elevational view thereof;

FIG. 6 is a top plan view thereof; and

FIG. 7 is a perspective view thereof.

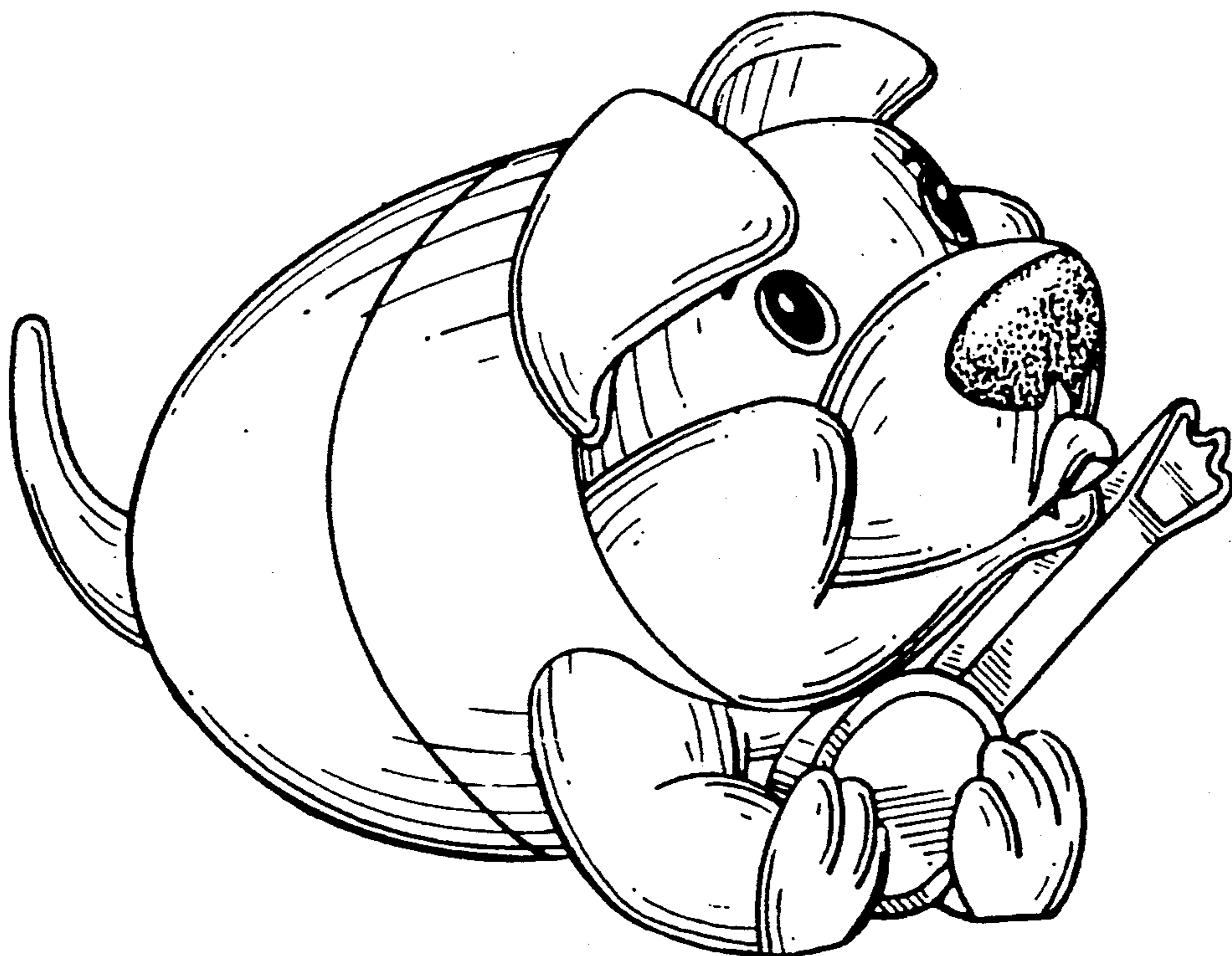

FIG. 1

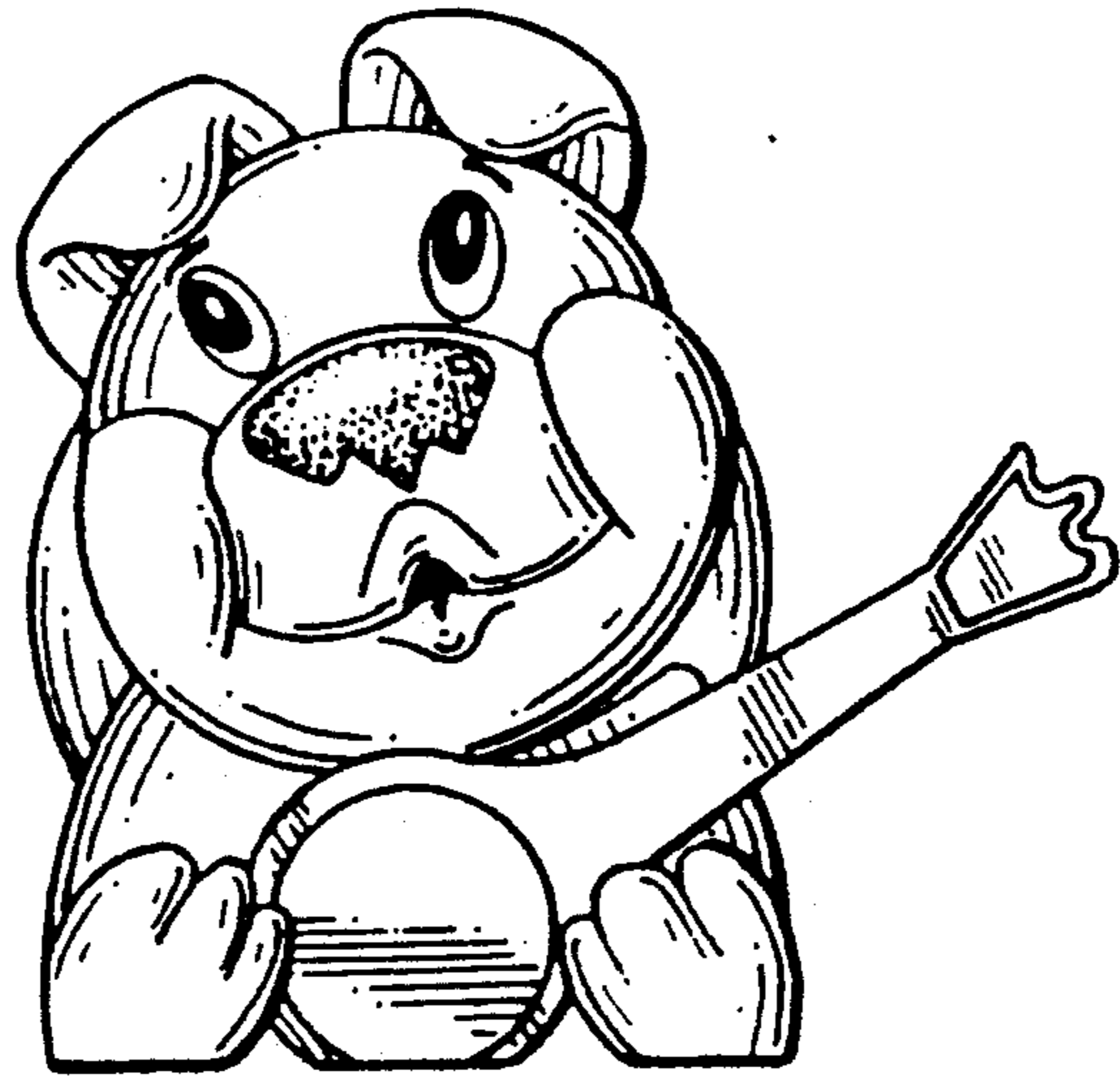

FIG. 2

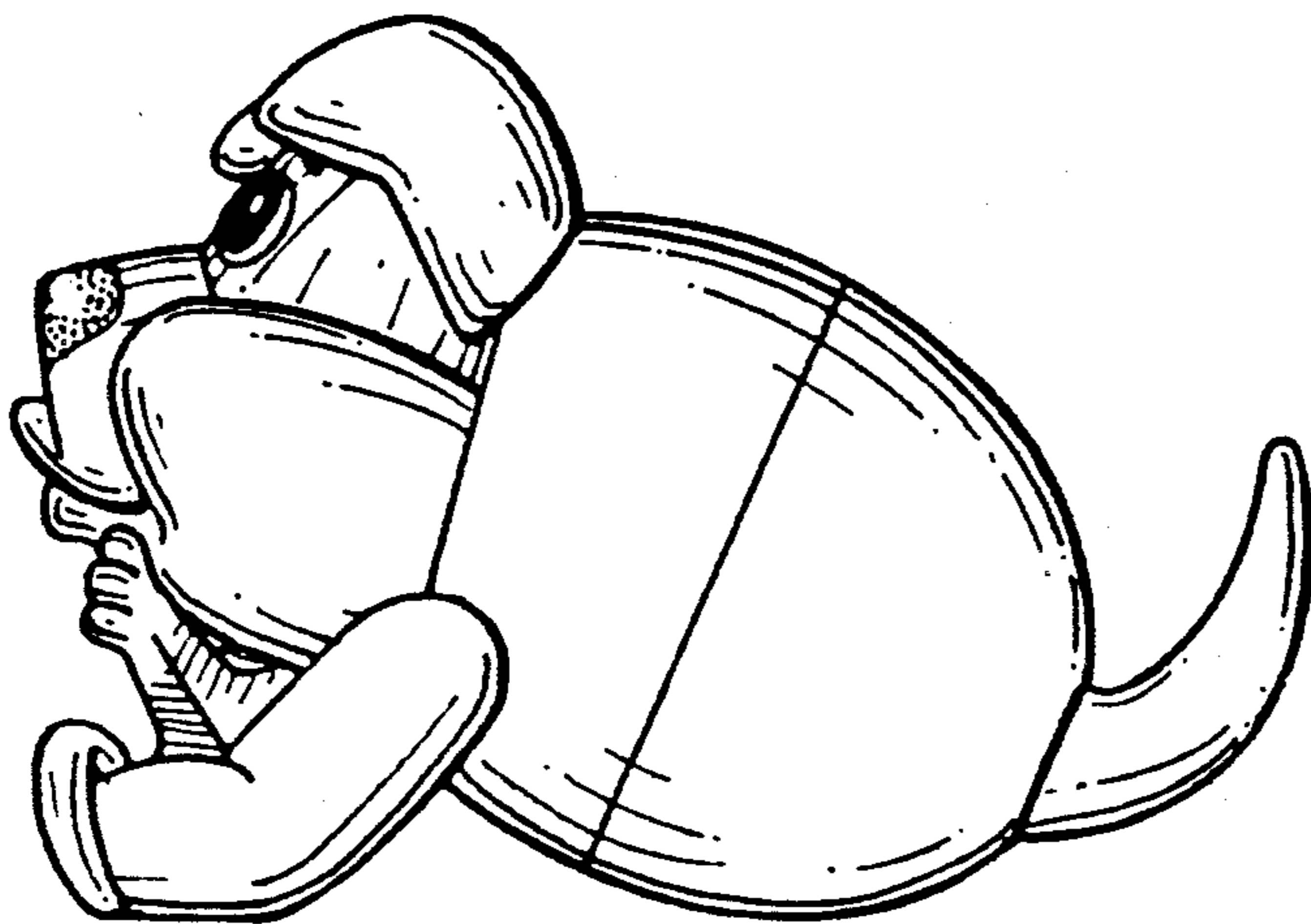

FIG. 3

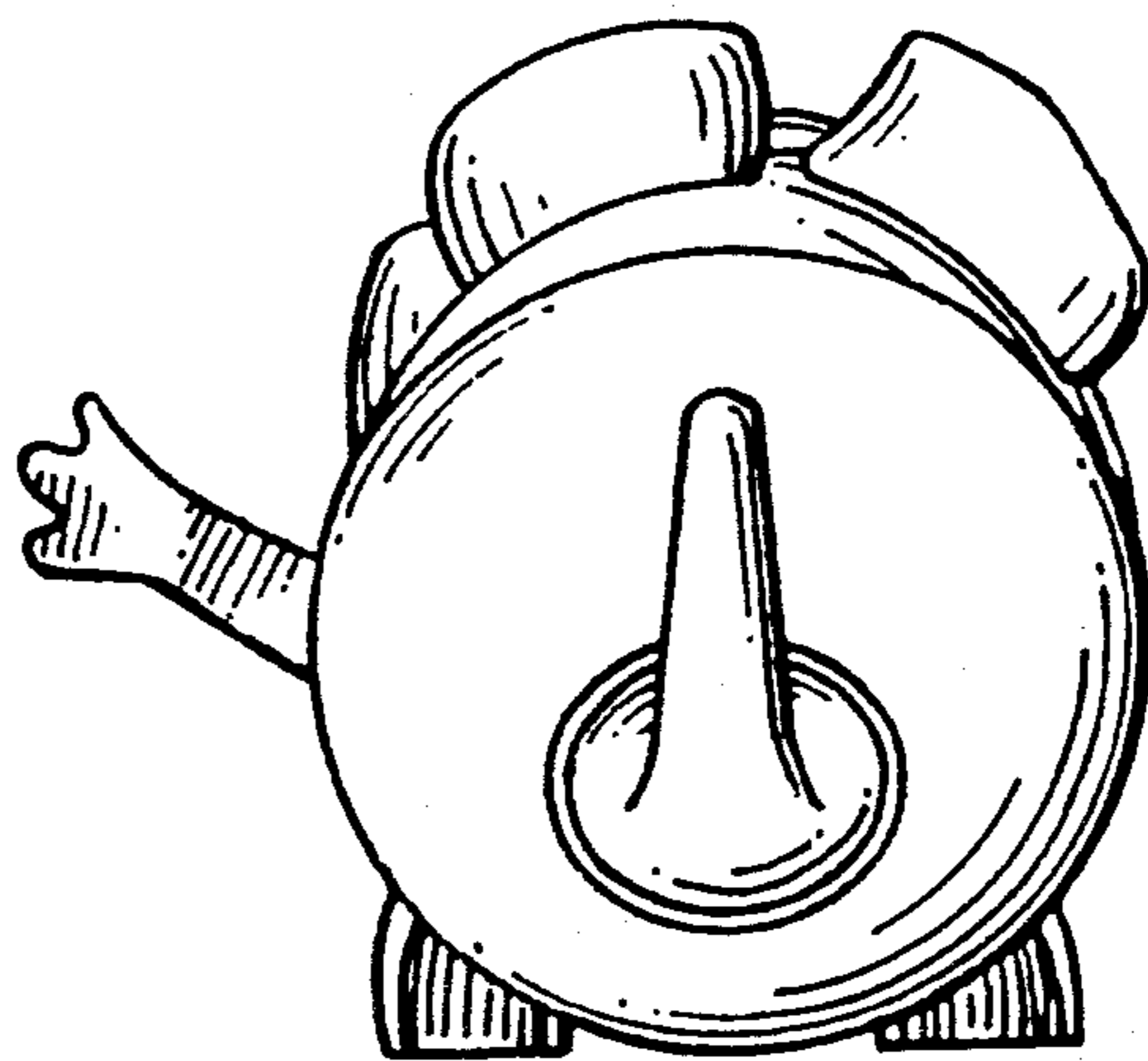

FIG. 4

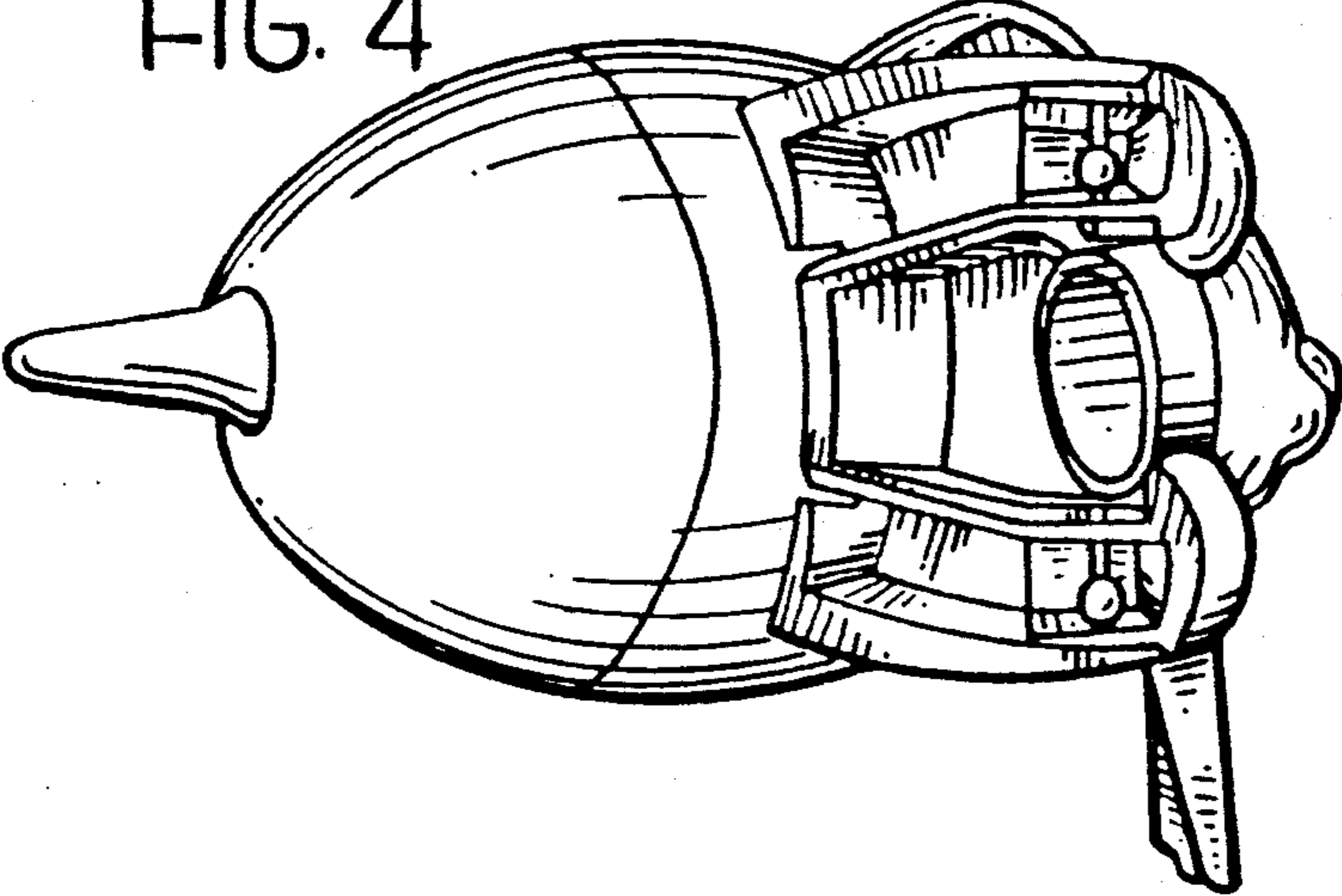

FIG. 5

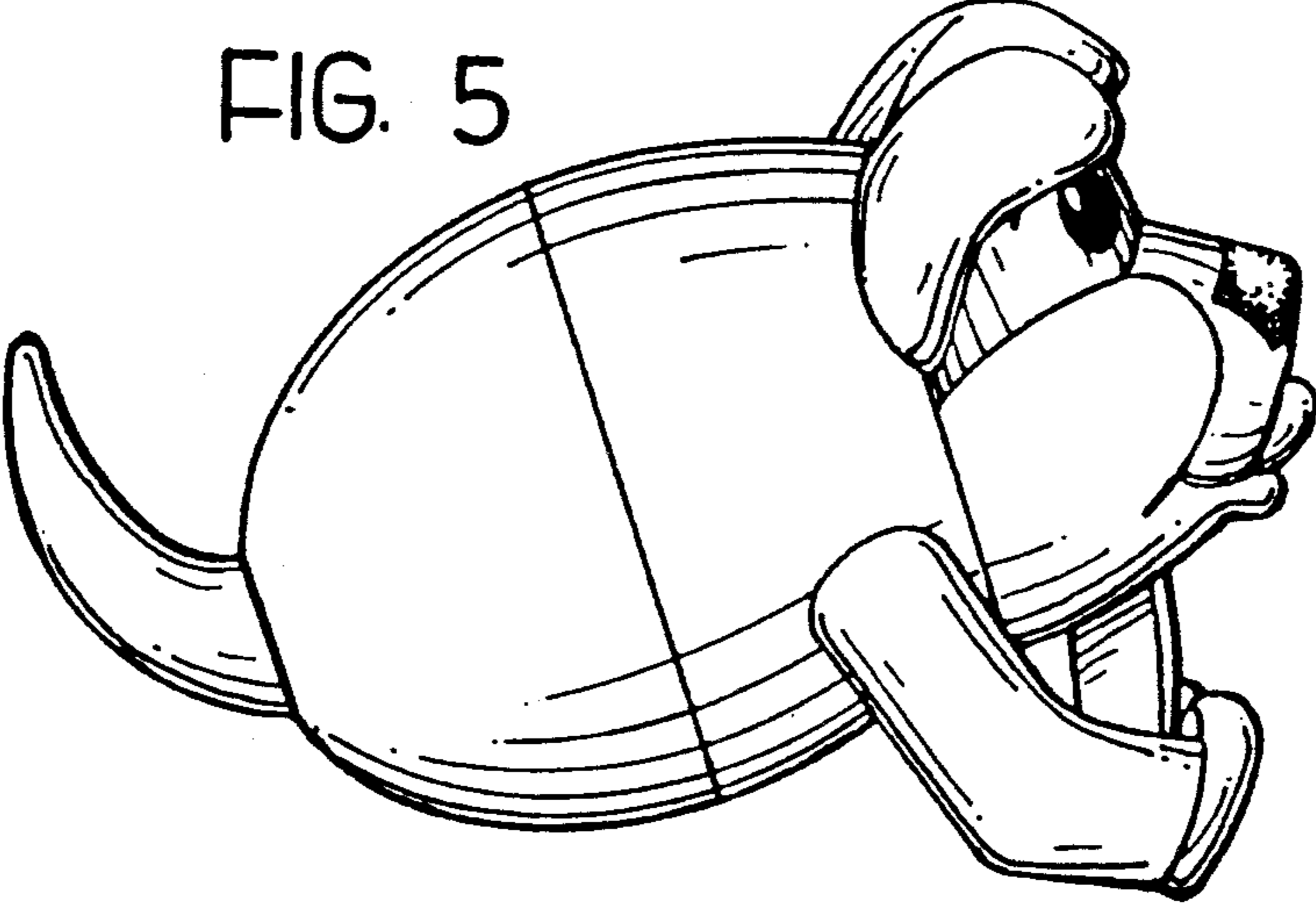

FIG. 6

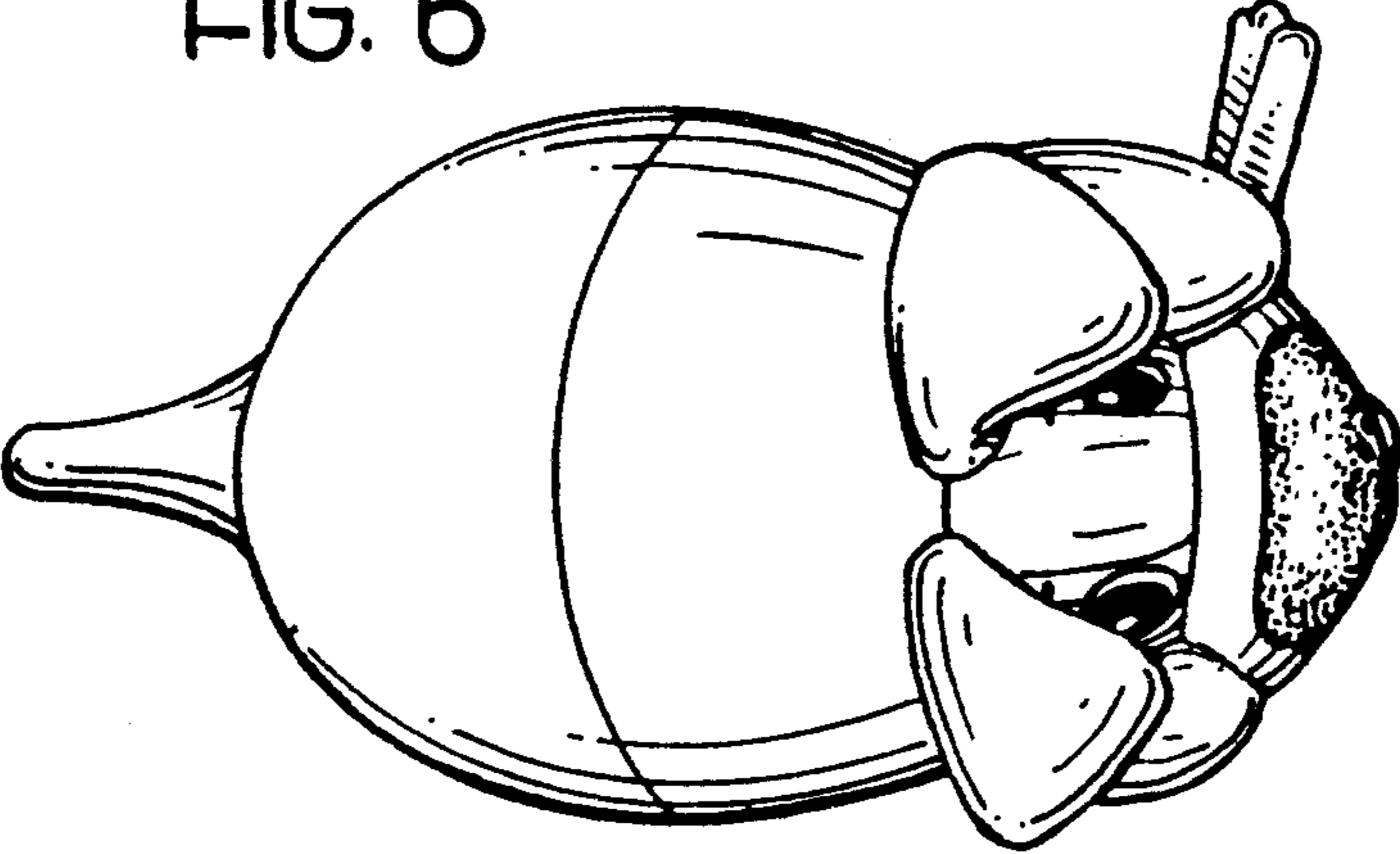

FIG. 7

