

[54] CHEST OR THE LIKE

[75] Inventor: Paul J. Gandy, Tucson, Ariz.

[73] Assignee: Marana Unique Products Inc.,
Tucson, Ariz.

[**] Term: 14 Years

[21] Appl. No.: 349,332

[22] Filed: May 8, 1989

[52] U.S. Cl. D6/440; D6/336

[58] Field of Search D6/432, 434, 435, 440,
D6/336, 345; 312/204

[56] References Cited

U.S. PATENT DOCUMENTS

D. 66,204	12/1924	McGlothern	D6/348
D. 78,508	5/1929	Duke	D6/336
D. 161,172	12/1950	Greene	D6/338
D. 173,828	1/1955	Ziebell	D6/336
D. 204,401	4/1966	McCartney	D6/440
D. 225,928	1/1973	Lockwood	D6/348

OTHER PUBLICATIONS

Sturbridge Yankee Workshop, p. 51; Solid Pine Pouting Chair, bottom left on page:

Primary Examiner—Carmen H. Vales-Lado
Attorney, Agent, or Firm—Mark E. Ogram

[57] CLAIM

The ornamental design for a chest or the like, as shown and described.

DESCRIPTION

FIG. 1 is a perspective view of a chest or the like showing my new design;
FIG. 2 is a right side elevational view, the left side being a mirror image thereof;
FIG. 3 is a front elevational view thereof;
FIG. 4 is a rear elevational view thereof;
FIG. 5 is a top plan view thereof;
FIG. 6 is a bottom plan view thereof;
FIG. 7 is a second embodiment of the ornament shown on the rear of the chest in FIG. 1;
FIG. 8 is a third embodiment of the ornament shown on the rear of the chest in FIG. 1; and
FIG. 9 is a fourth embodiment of the ornament shown on the rear of the chest in FIG. 1.

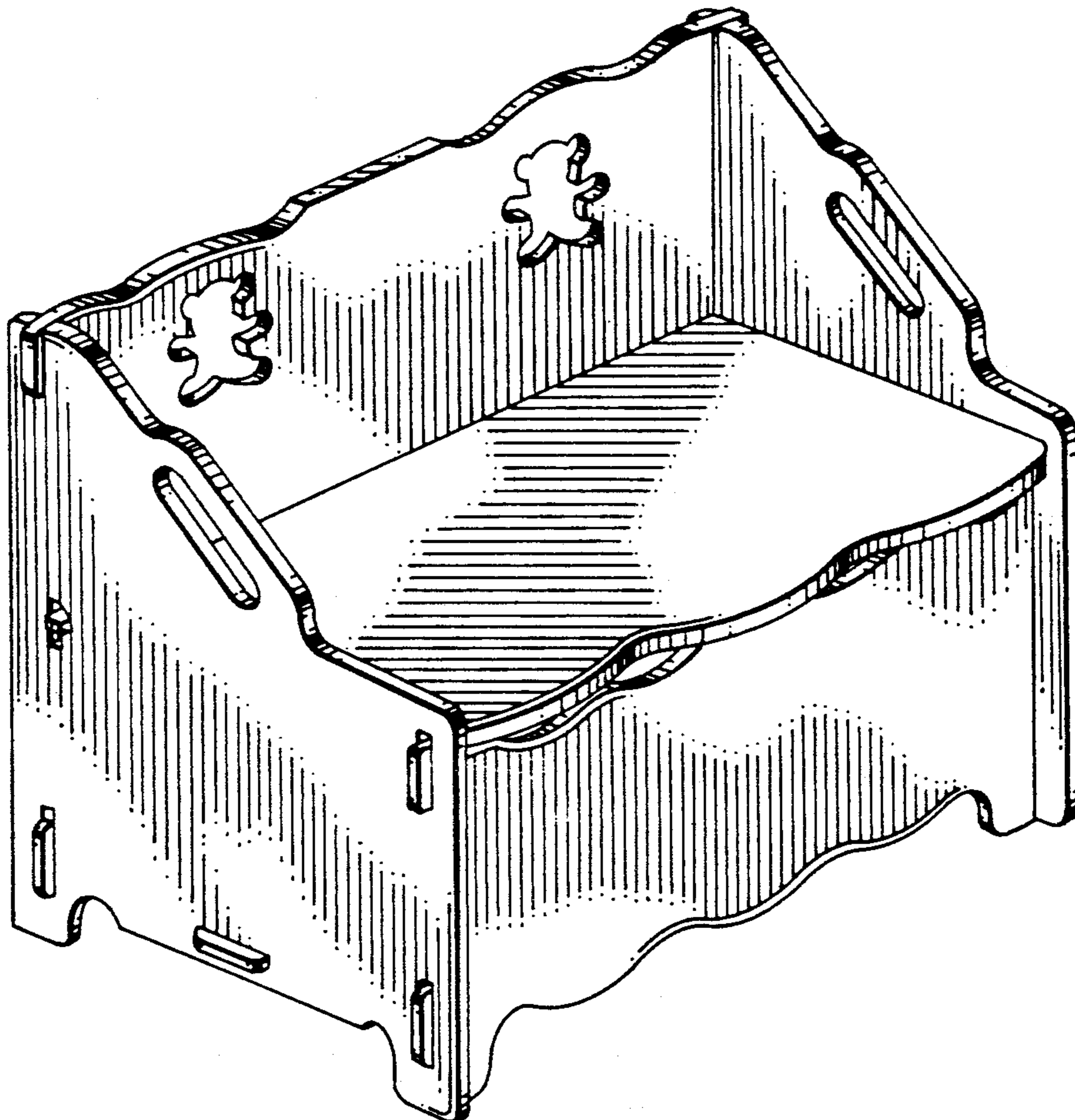

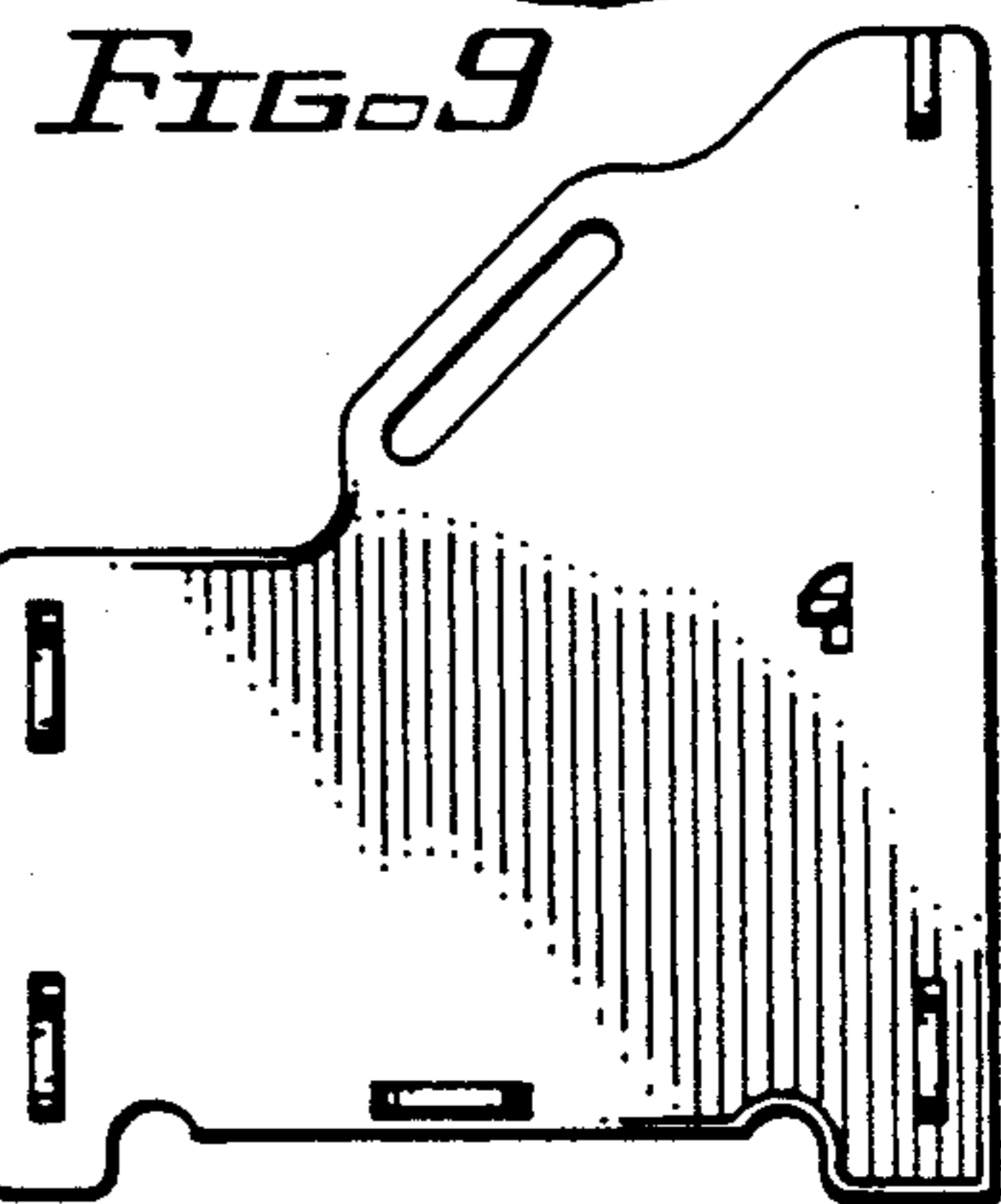
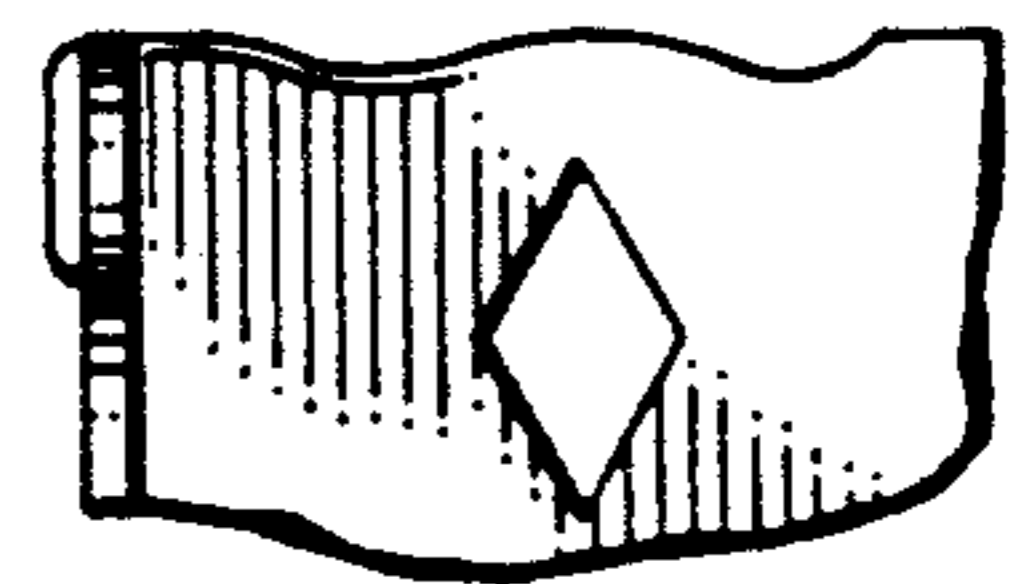
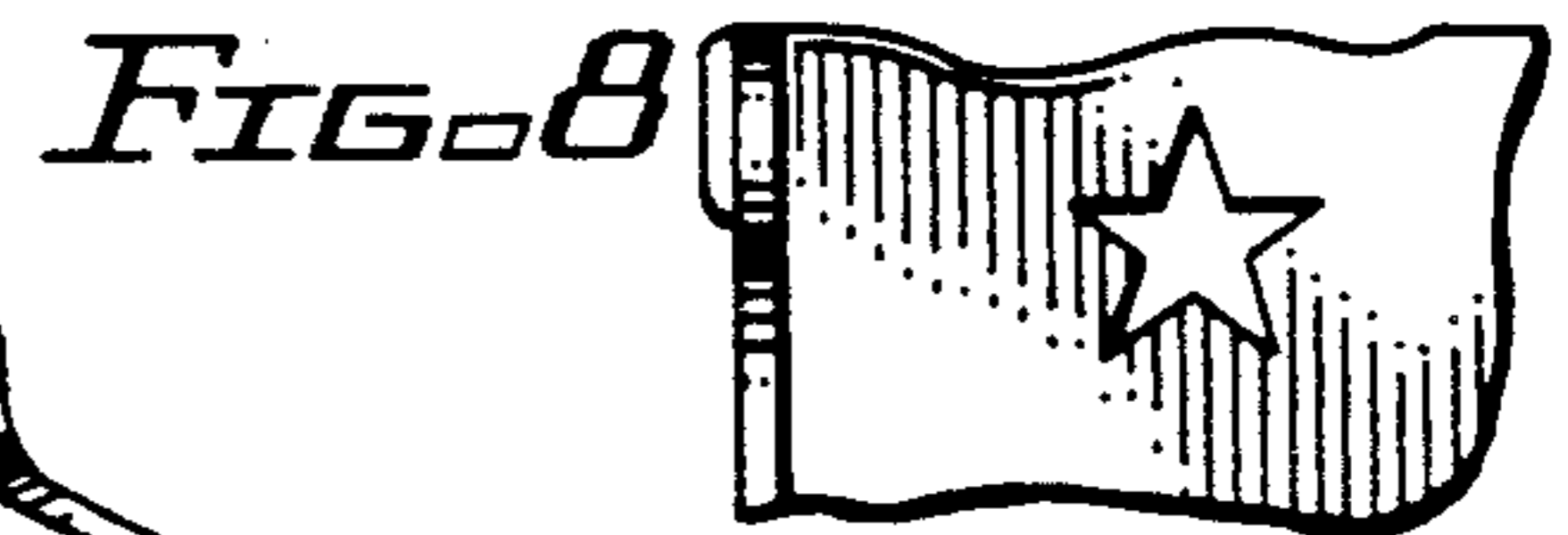
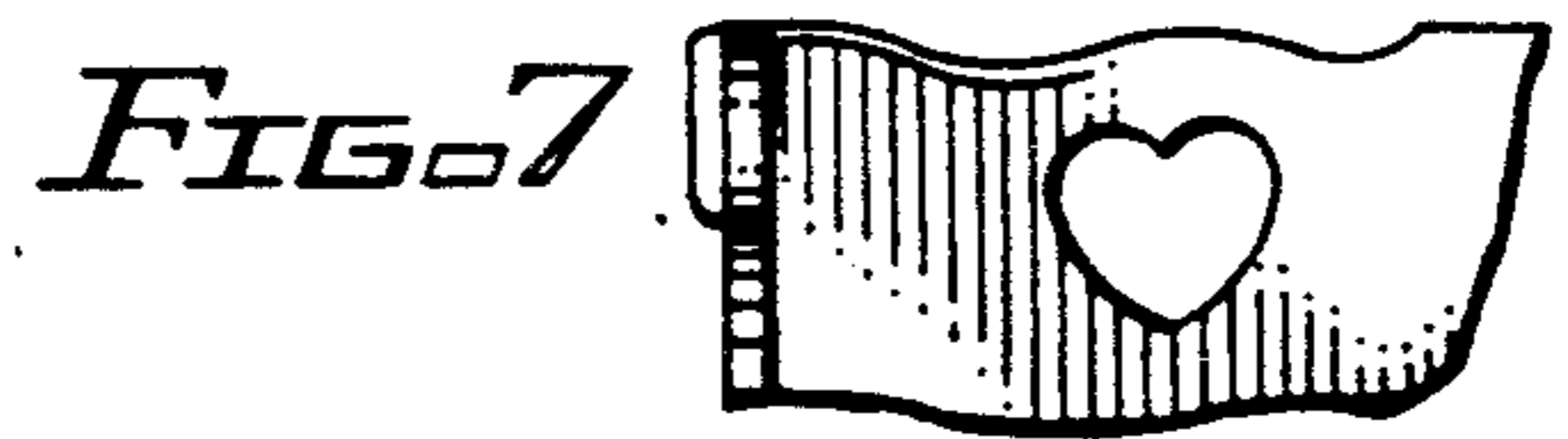
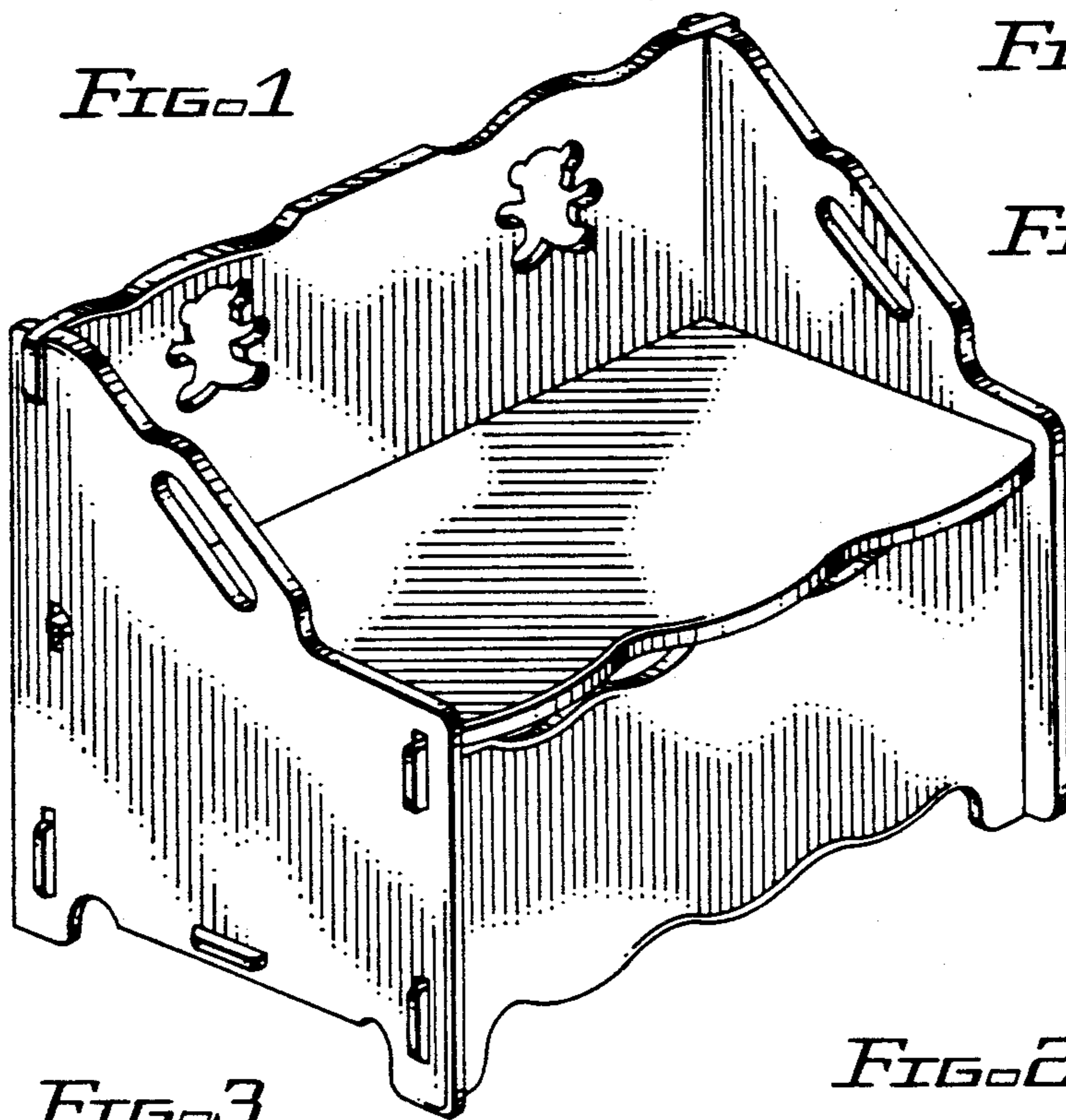

FIG. 2

FIG. 3

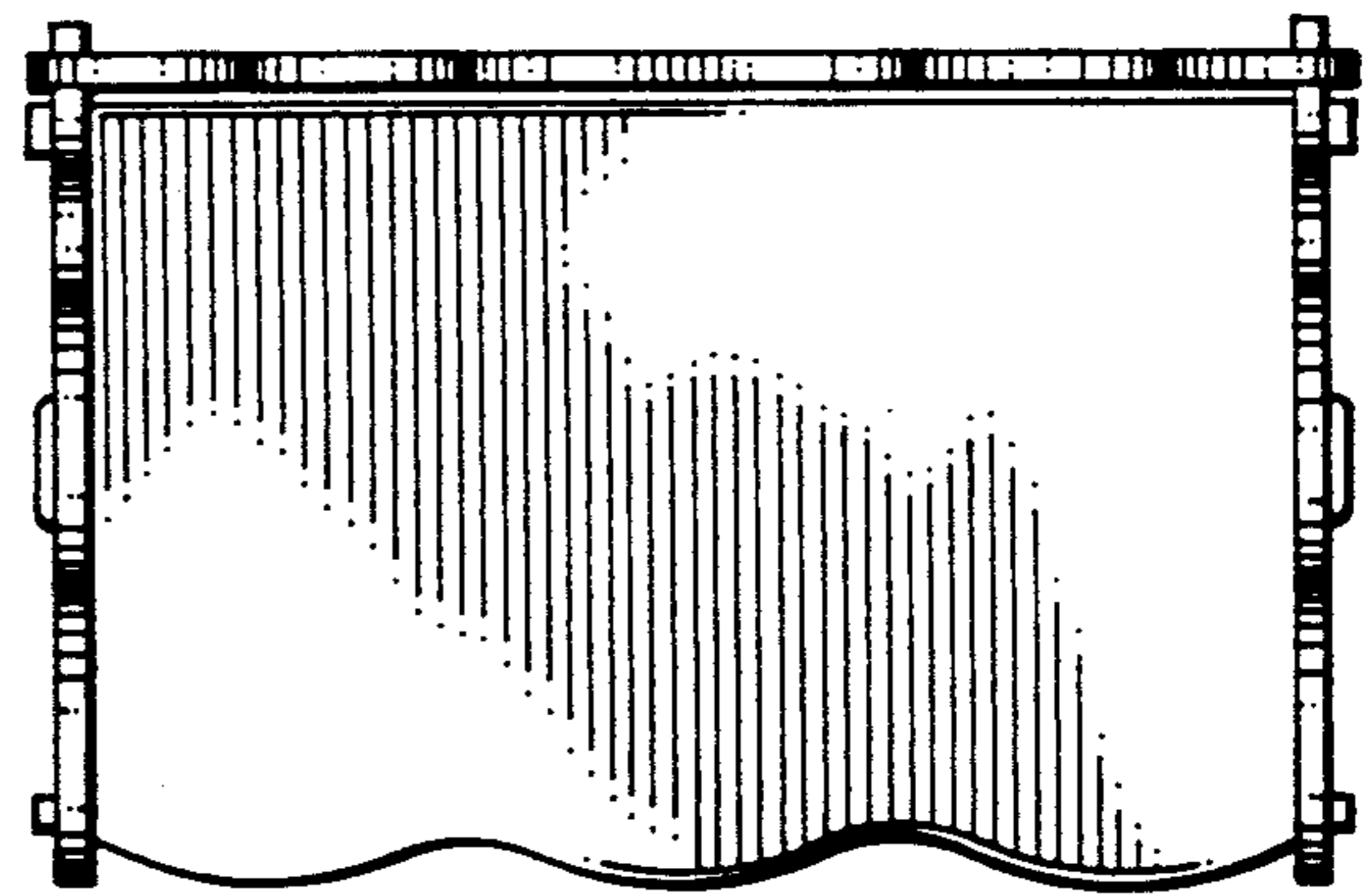
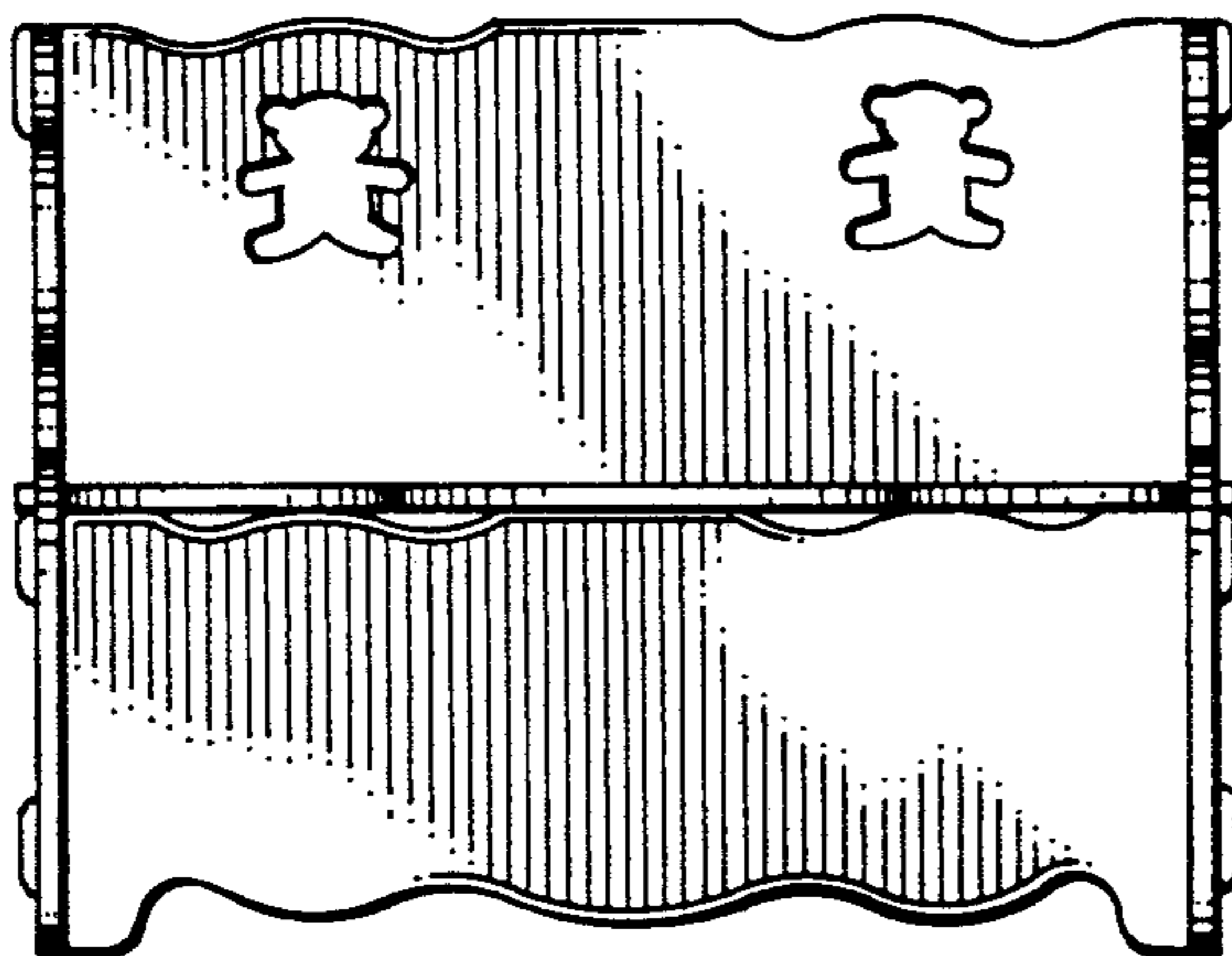

FIG. 4

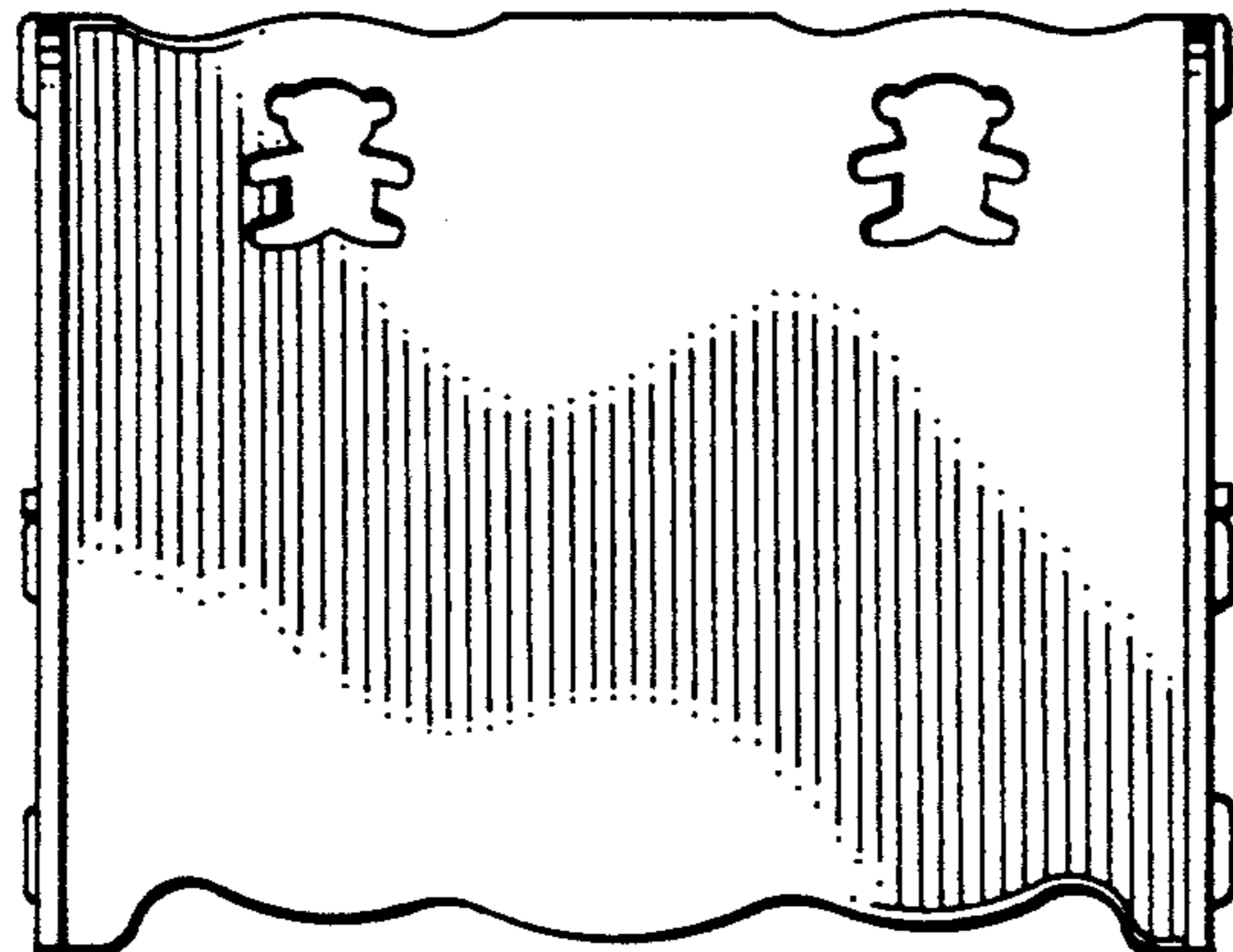

FIG. 5

