

[54] RECLINER PANE FOR TANNING APPARATUS

[76] Inventor: Friedrich Wolff, Störklingasse 44, CH-4125 Riehen/Basel, Switzerland

[**] Term: 14 Years

[21] Appl. No.: 71,611

[22] Filed: Jul. 8, 1987

[30] Foreign Application Priority Data

Apr. 8, 1987 [DE] Fed. Rep. of Germany URA416/87

[52] U.S. Cl. D24/200

[58] Field of Search D24/39, 38; 128/377, 128/367, 371, 376; 4/524, 531, 532, 589, 496, 542, 573, 575

[56] References Cited

U.S. PATENT DOCUMENTS

D. 266,788 11/1982 Du Bois et al. D24/38

D. 298,055 10/1988 O'Brien D24/38 X
4,663,787 5/1987 Kölsch 128/376 X

Primary Examiner—Stella Reid
Attorney, Agent, or Firm—Peter K. Kontler

[57] CLAIM

The ornamental design for a recliner pane for tanning apparatus, as shown and described.

DESCRIPTION

FIG. 1 is a front perspective view of a recliner pane for tanning apparatus, showing my new design; FIG. 2 is a bottom perspective view thereof; FIG. 3 is an enlarged top plan view thereof; FIG. 4 is a longitudinal cross-sectional view taken along line IV—IV of FIG. 3; FIG. 5 is a transverse cross-sectional view taken along line V—V of FIG. 3; FIG. 6 is another front perspective view thereof; FIG. 7 is a side elevational view thereof; and FIG. 8 is an end elevational view thereof.

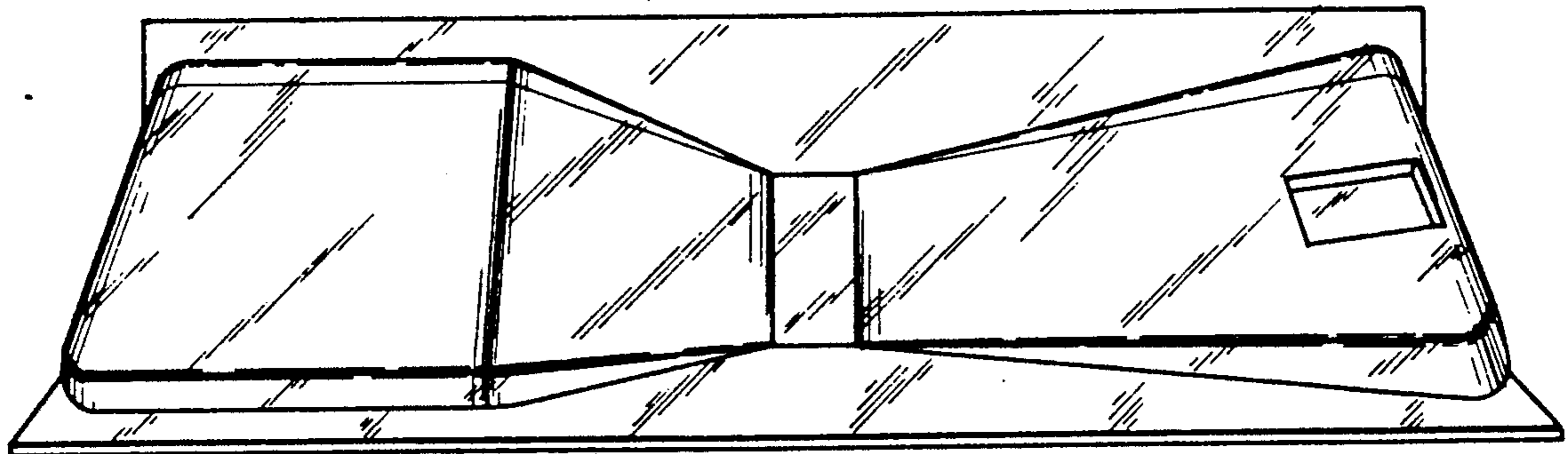

Fig. 1

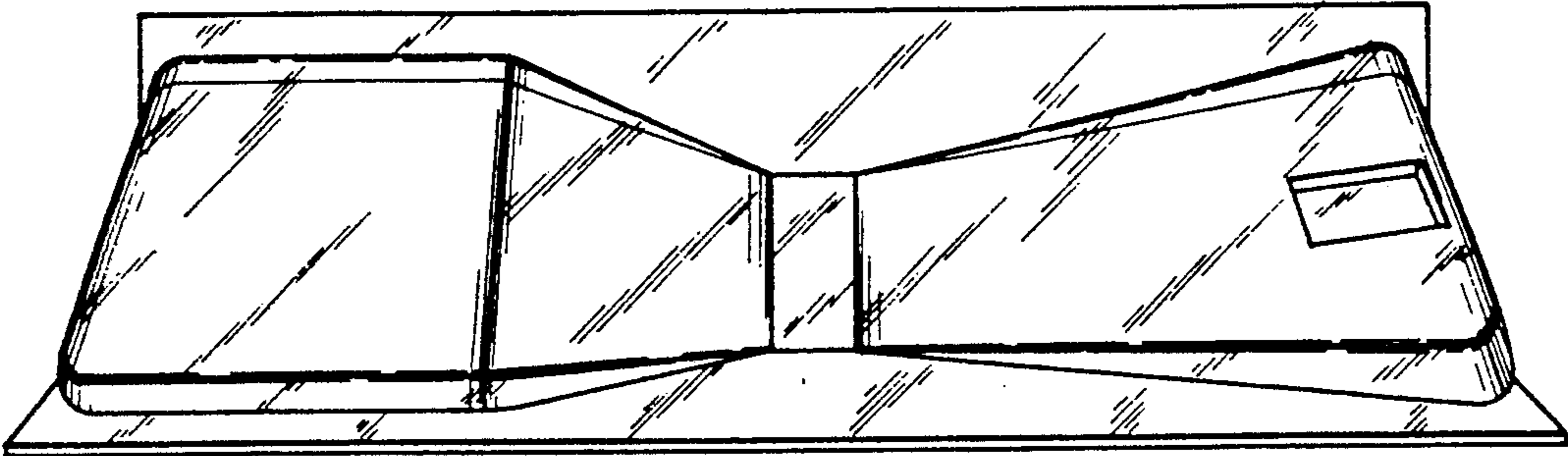

Fig. 2

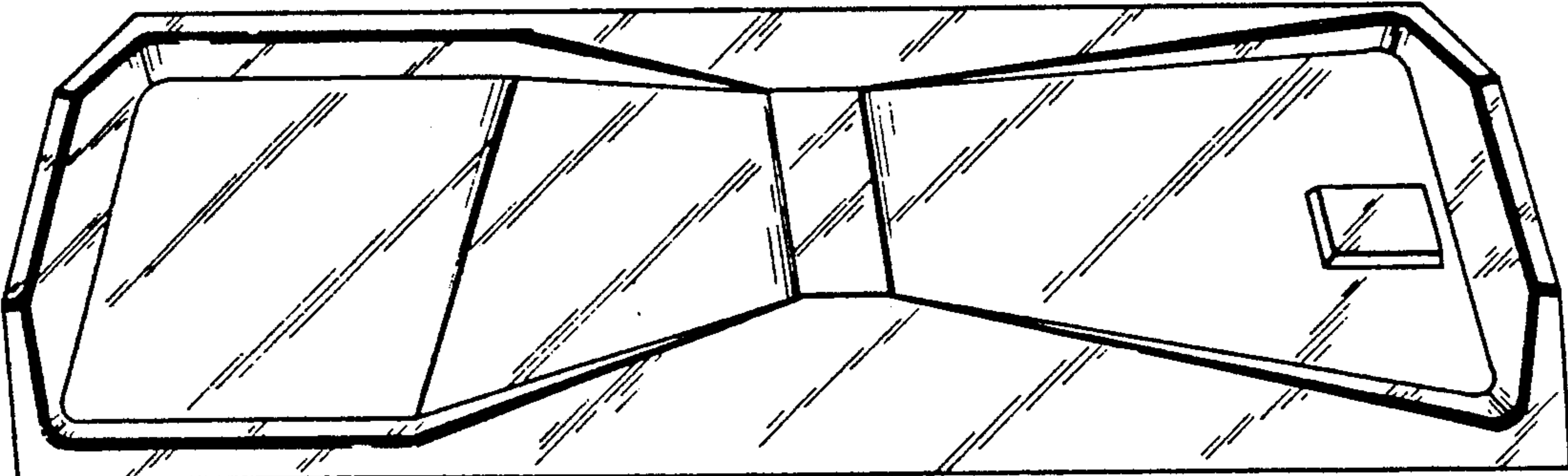

Fig. 5

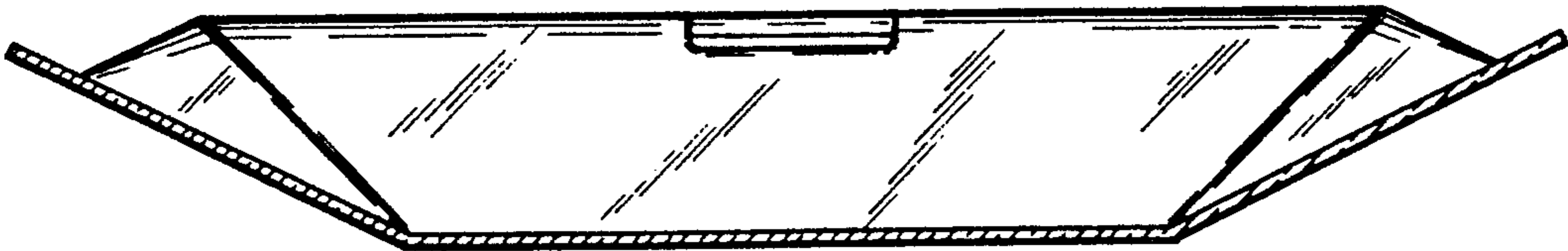

Fig. 4



Fig. 3

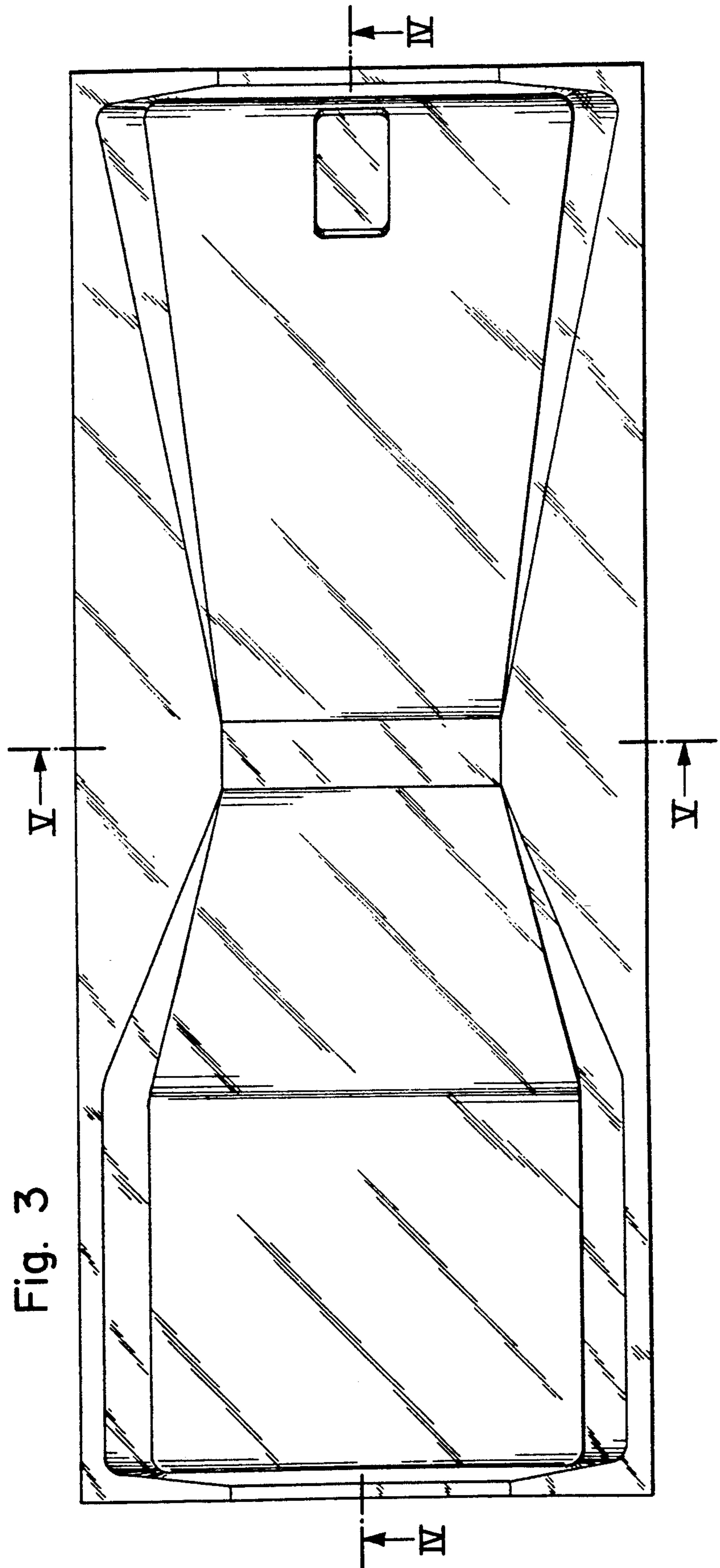

Fig. 6

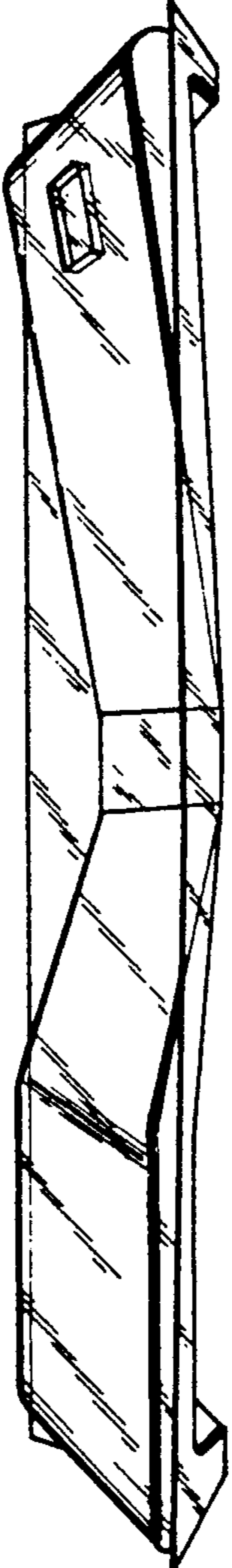

Fig. 7

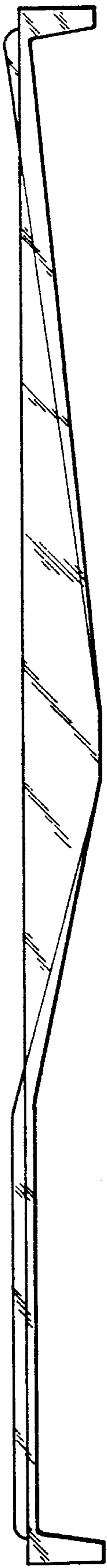

Fig. 8

