

[54] GOLF BALL TEE SETTER

[76] Inventor: Glen O. Axne, 121 W. 4th St., Coal Valley, Ill. 61240

[**] Term: 14 Years

[21] Appl. No.: 337,166

[22] Filed: Apr. 12, 1989

[52] U.S. Cl. D21/208

[58] Field of Search D21/208, 234; 273/32 D, 273/32 A, 32 B, 162 C, 162 D, 32.5

[56] References Cited

U.S. PATENT DOCUMENTS

- D. 306,881 3/1990 Rice D21/37
- 3,658,331 4/1972 Driscoll 273/32.5
- 4,335,838 6/1982 Bisk et al. D6/328 X

Primary Examiner—Terry A. Pfeffer
Attorney, Agent, or Firm—Robert O. Richardson

[57] CLAIM

The ornamental design for a golf ball tee setter, as shown and described.

DESCRIPTION

FIG. 1 is a perspective view of a golf ball tee setter showing my new design;
 FIG. 2 is a front elevational view thereof, the opposite side being identical;
 FIG. 3 is a top plan view thereof;
 FIG. 4 is a side elevational view thereof;
 FIG. 5 is a front elevational view of an alternate embodiment of FIG. 1, the opposite side being identical;
 FIG. 6 is a side elevational view of FIG. 5;
 FIG. 7 is a top plan view of FIG. 5;
 FIG. 8 is a front elevational view of an alternate embodiment of FIG. 1; the opposite side being identical;
 FIG. 9 is a side elevational view of FIG. 8; and
 FIG. 10 is a top plan view of FIG. 8.
 The tee is shown in broken lines for illustrative purposes only.

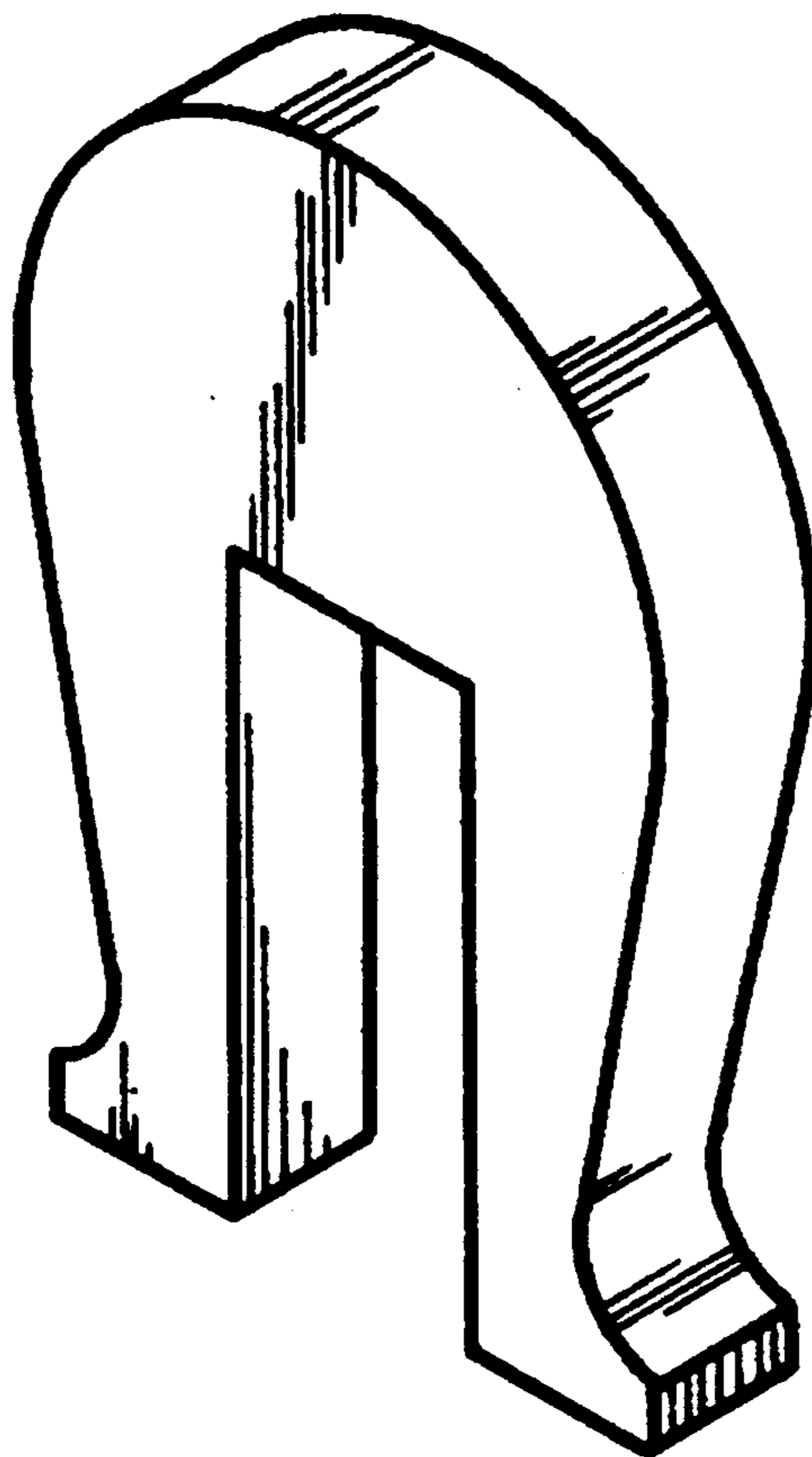

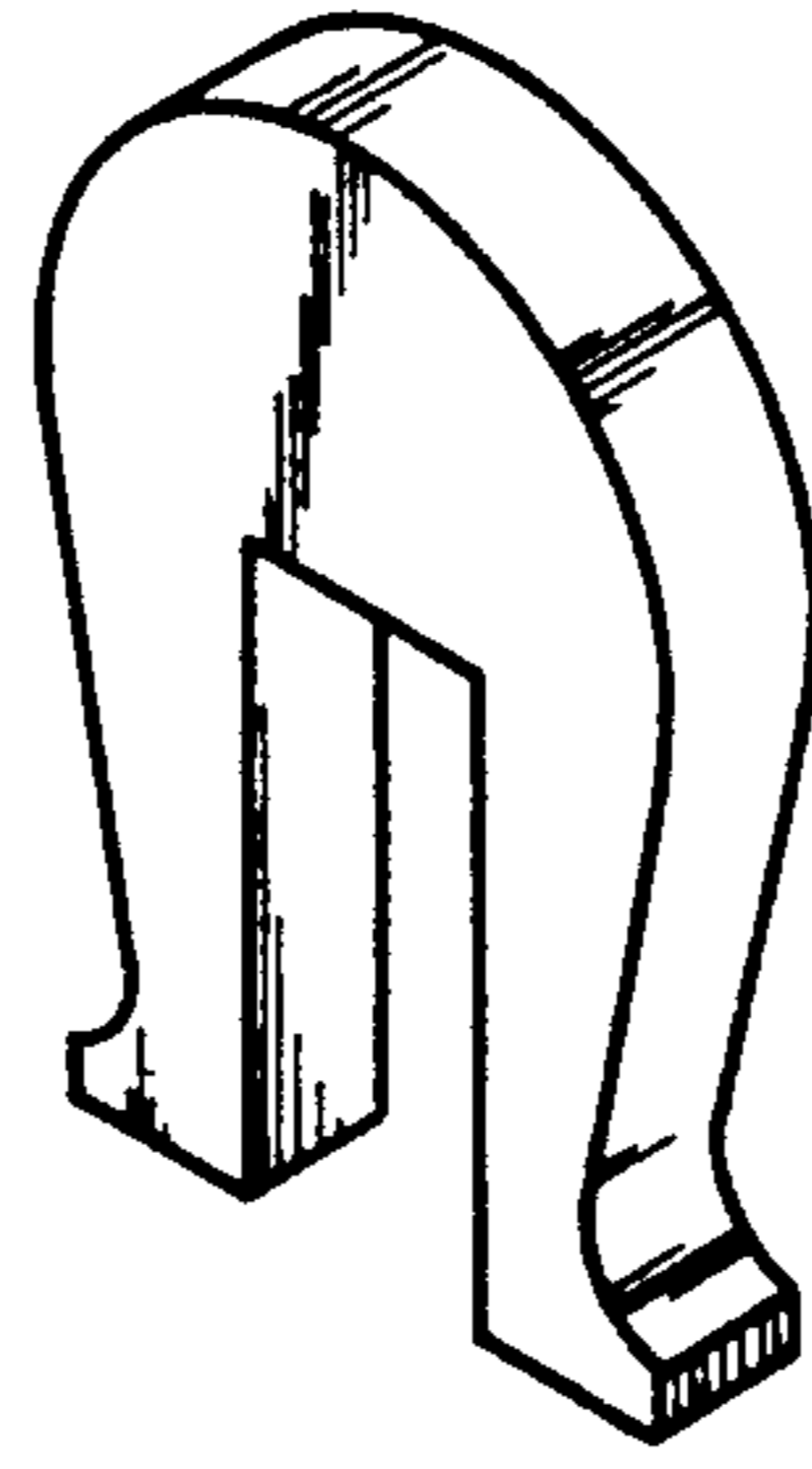

Fig. 1

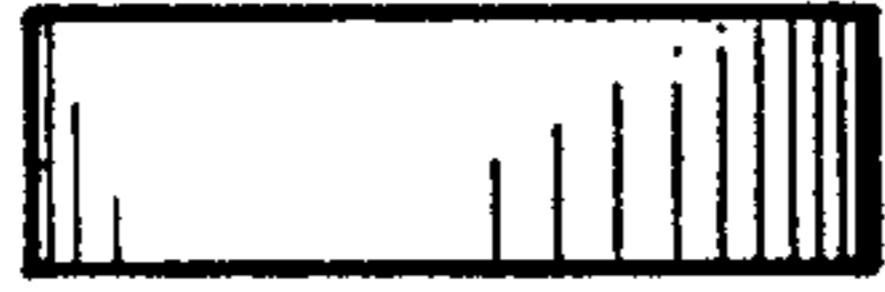

Fig. 3

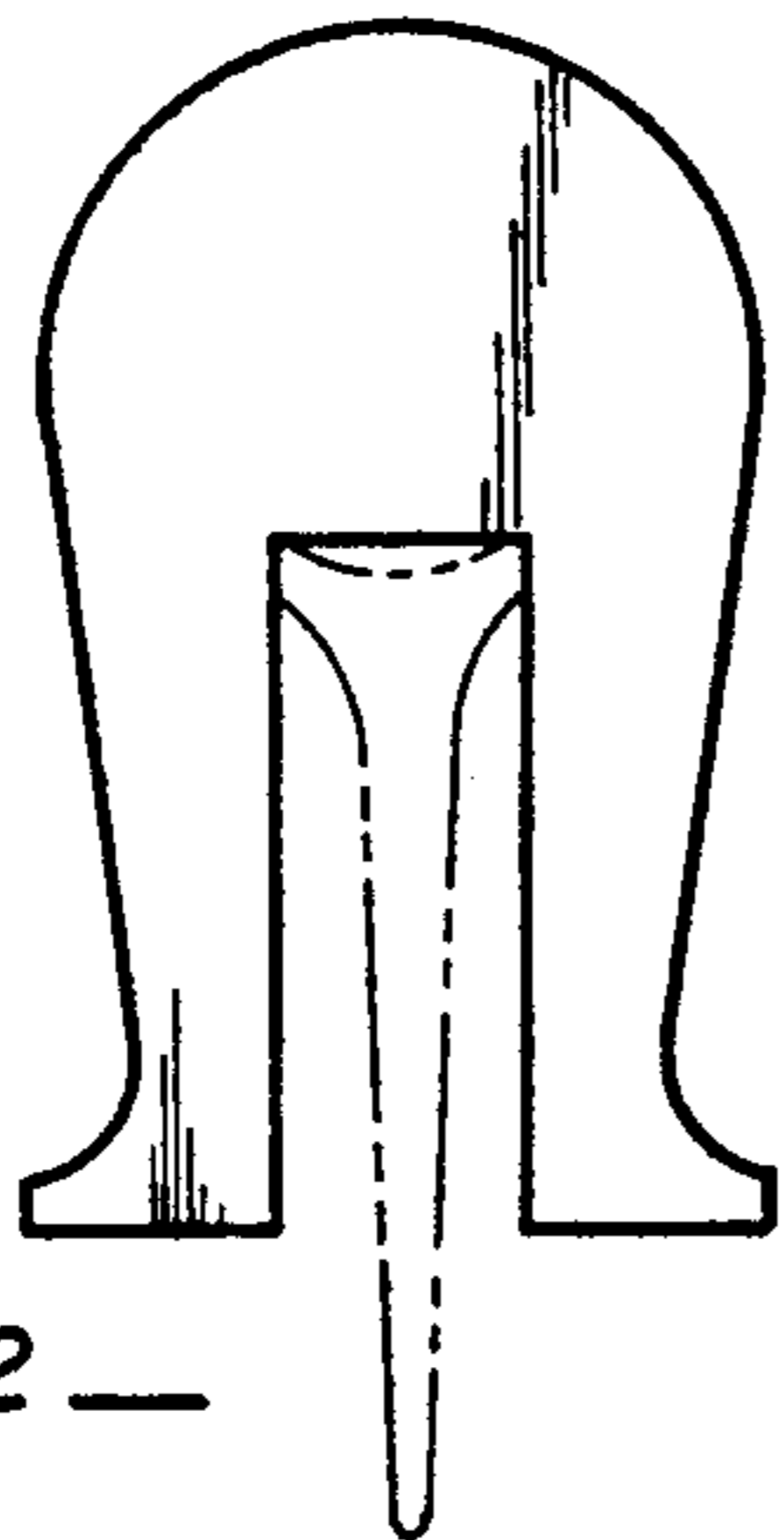

Fig. 2

Fig. 4

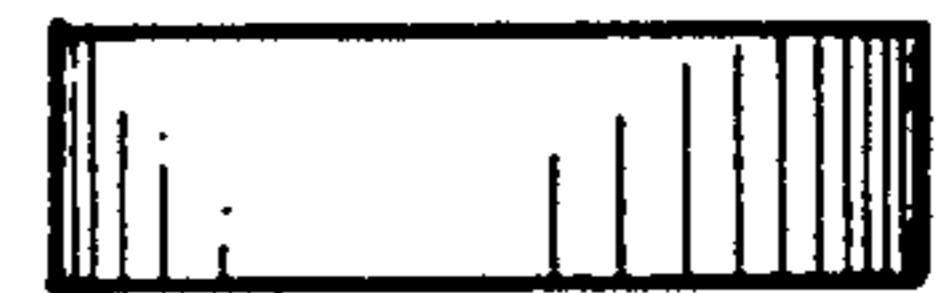
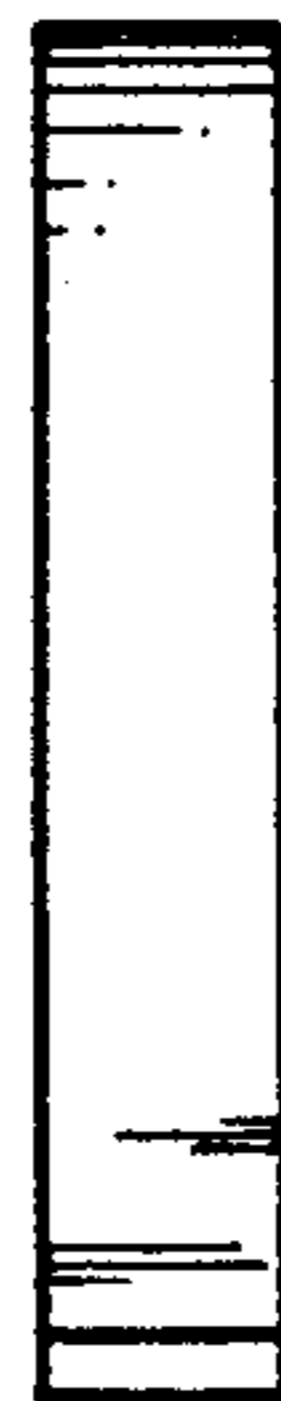

Fig. 7



Fig. 6

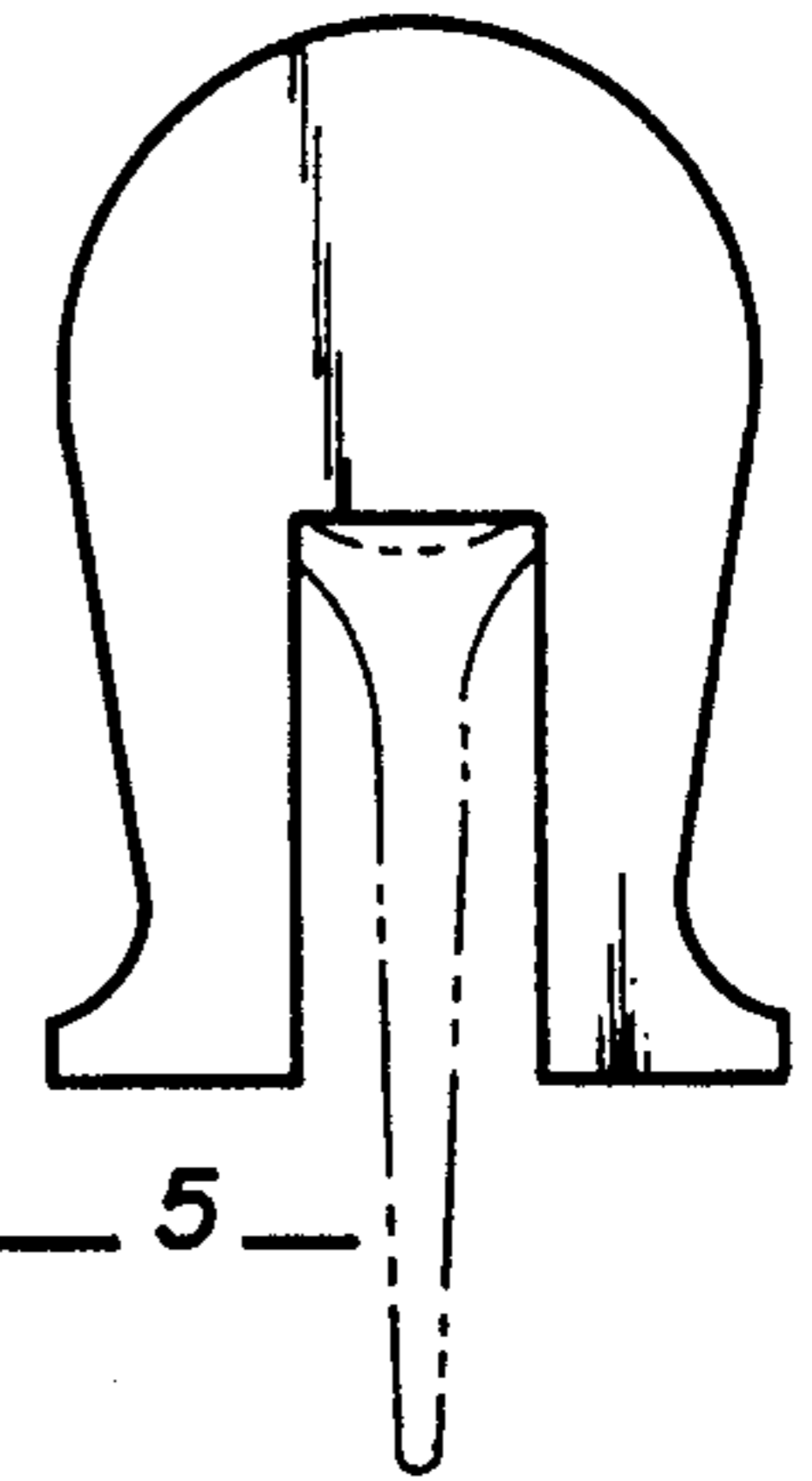

Fig. 5



Fig. 10



Fig. 9

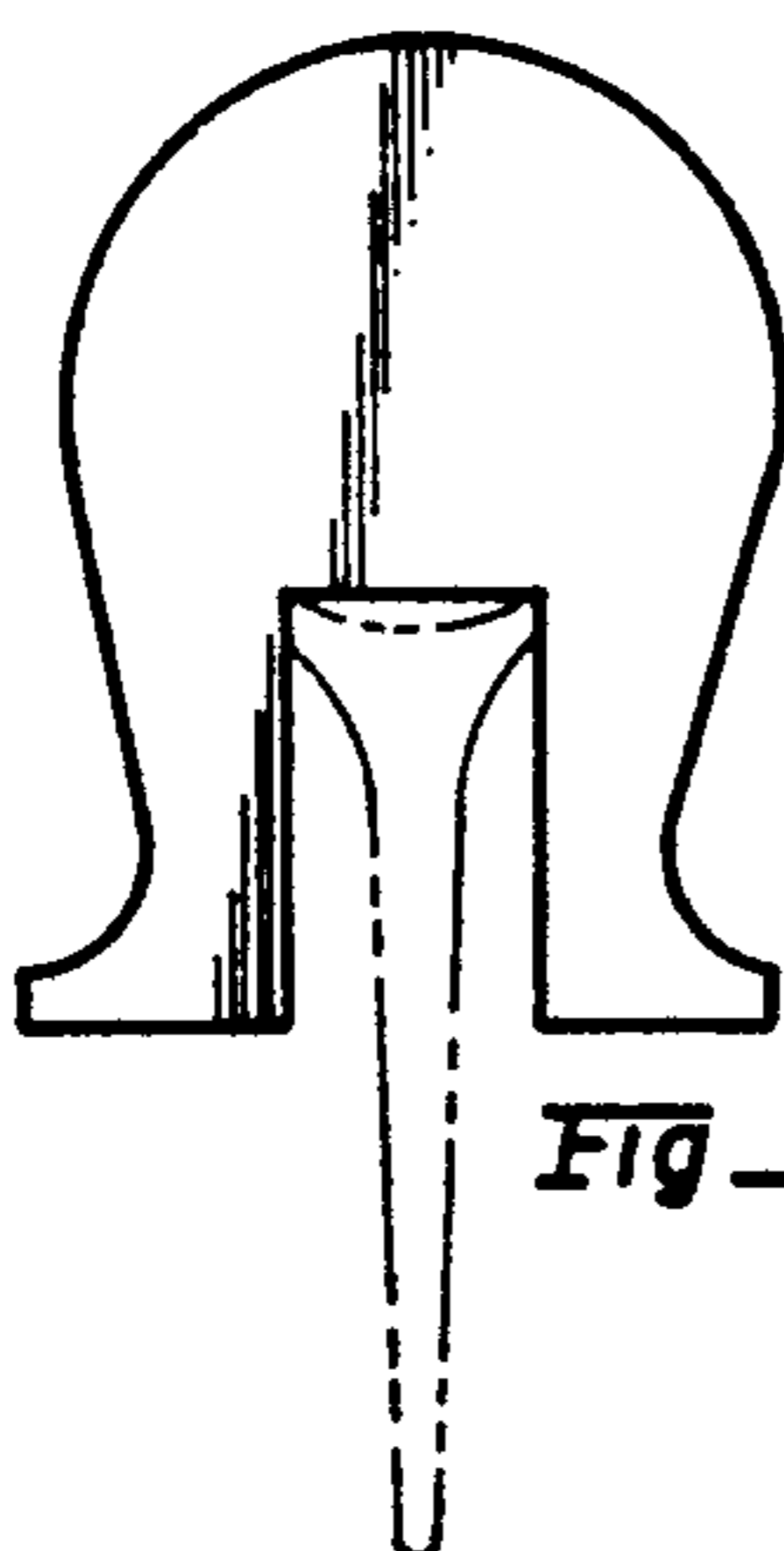

Fig. 8