

[54] **CASSETTE TAPE PLAYER**

[75] **Inventor: Hiroyuki Miyai, Matsubara, Japan**

[73] **Assignee: Sanyo Electric Co., Ltd., Osaka, Japan**

[**] **Term: 14 Years**

[21] **Appl. No.: 365,510**

[22] **Filed: Jun. 13, 1989**

[30] **Foreign Application Priority Data**

Dec. 14, 1988 [JP] Japan 63-48992

[52] **U.S. Cl. D14/165; D14/168; D21/113**

[58] **Field of Search D14/160-165, D14/167-168, 188, 192; D21/111-113**

[56] **References Cited**

U.S. PATENT DOCUMENTS

- D. 304,832 11/1989 Murphy D14/165
- D. 310,525 9/1990 Camens D14/168 X
- D. 311,006 10/1990 Hino et al. D14/165
- D. 313,415 1/1991 Ikeya et al. D14/165

FOREIGN PATENT DOCUMENTS

- 633188 4/1984 Japan .
- 635085 9/1984 Japan .
- 699289 2/1987 Japan .

Primary Examiner—Theodore M. Shooman
Attorney, Agent, or Firm—Darby & Darby

[57] **CLAIM**

The ornamental design for a cassette tape player, as shown and described.

DESCRIPTION

FIG. 1 is a top, front and right side perspective view of a cassette tape player showing my new design; FIG. 2 is a top, front and right side perspective view thereof, shown with the handle raised and the door to the cassette receiving compartment open; FIG. 3 is a front elevational view thereof; FIG. 4 is a rear elevational view thereof; FIG. 5 is a top plan view thereof; FIG. 6 is a bottom plan view thereof; FIG. 7 is a left side elevational view thereof; and FIG. 8 is a right side elevational view thereof. The broken line showing of the microphone and its holder in FIG. 2 is for illustrative purposes only and forms no part of the claimed design.

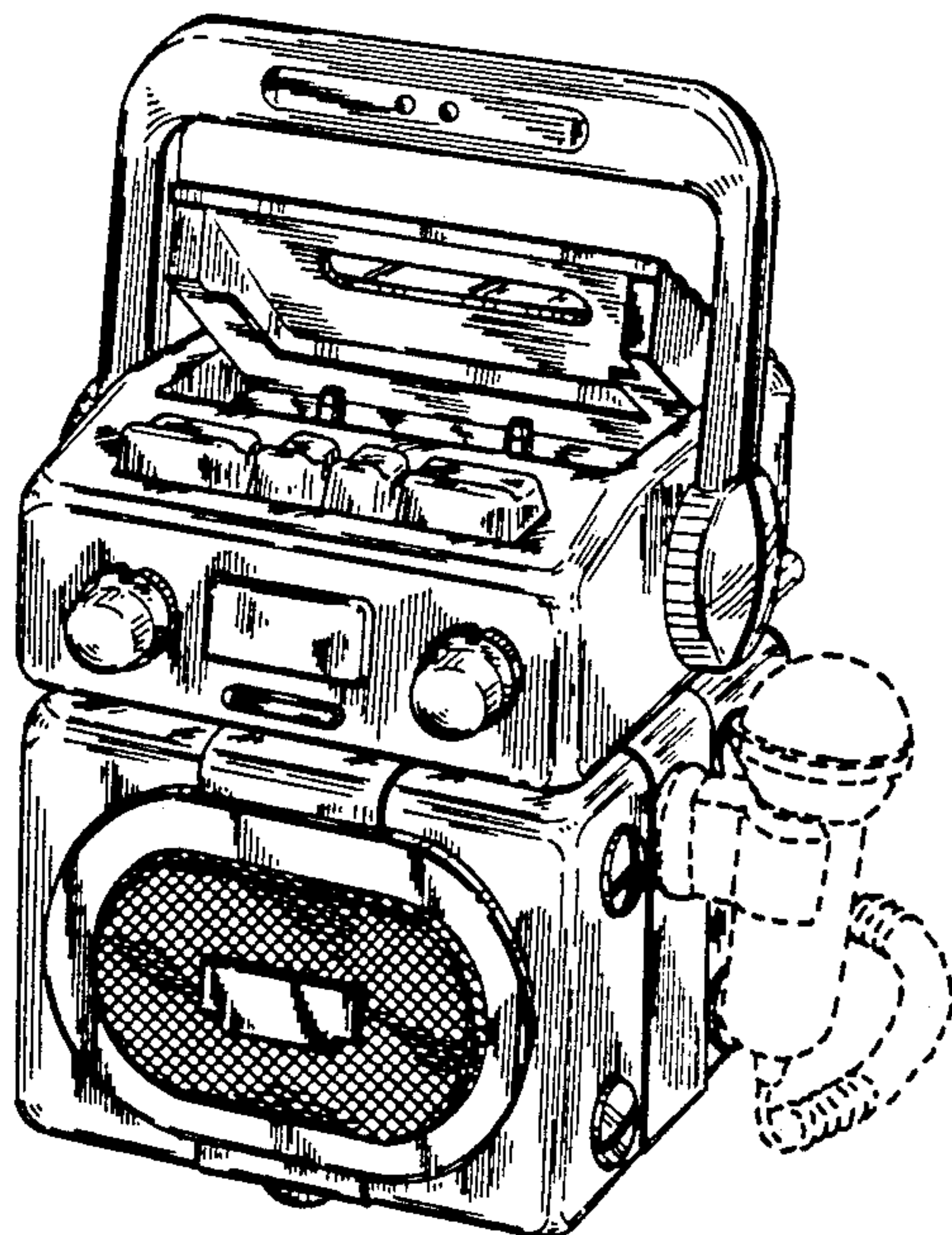
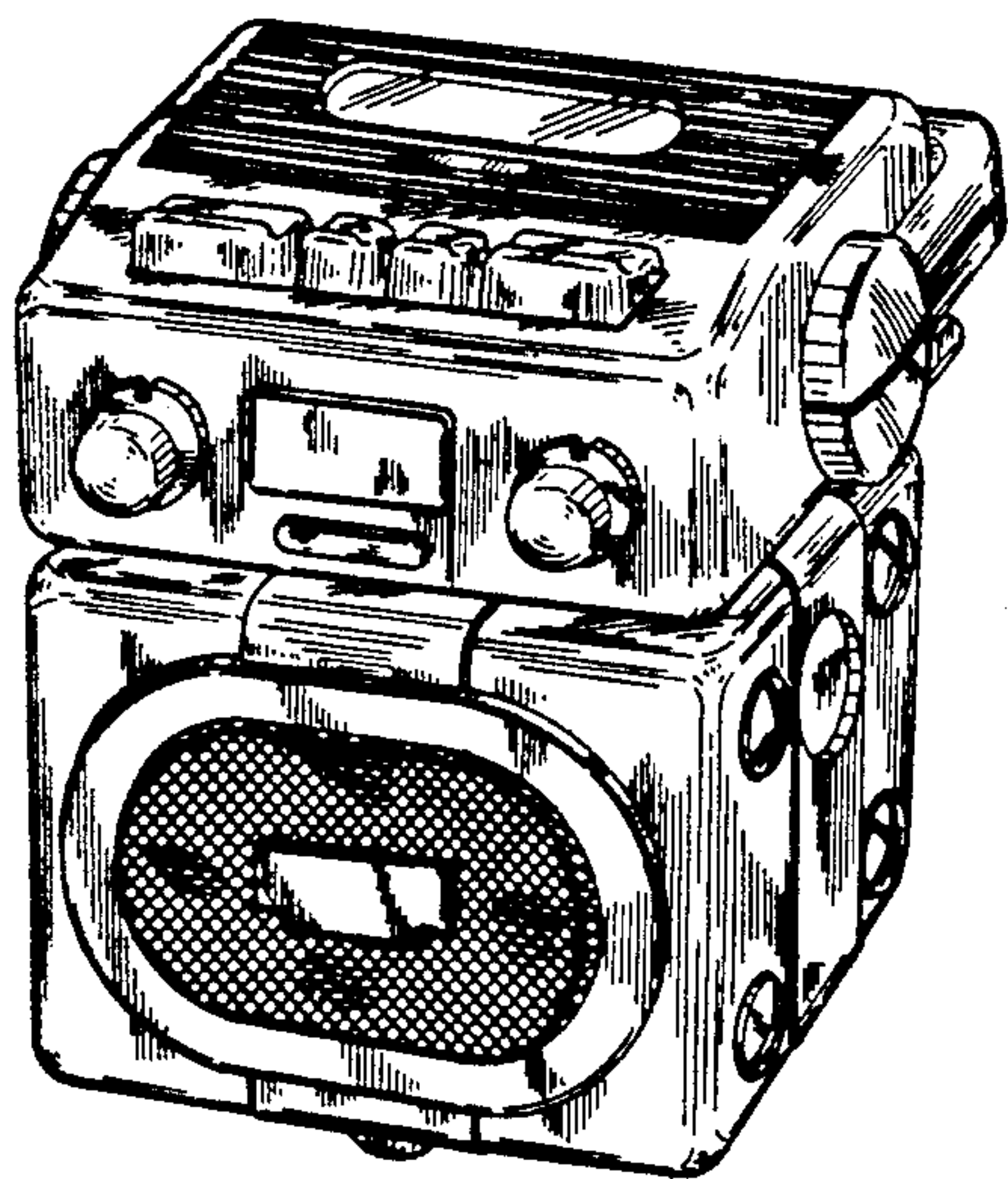

FIG. 2

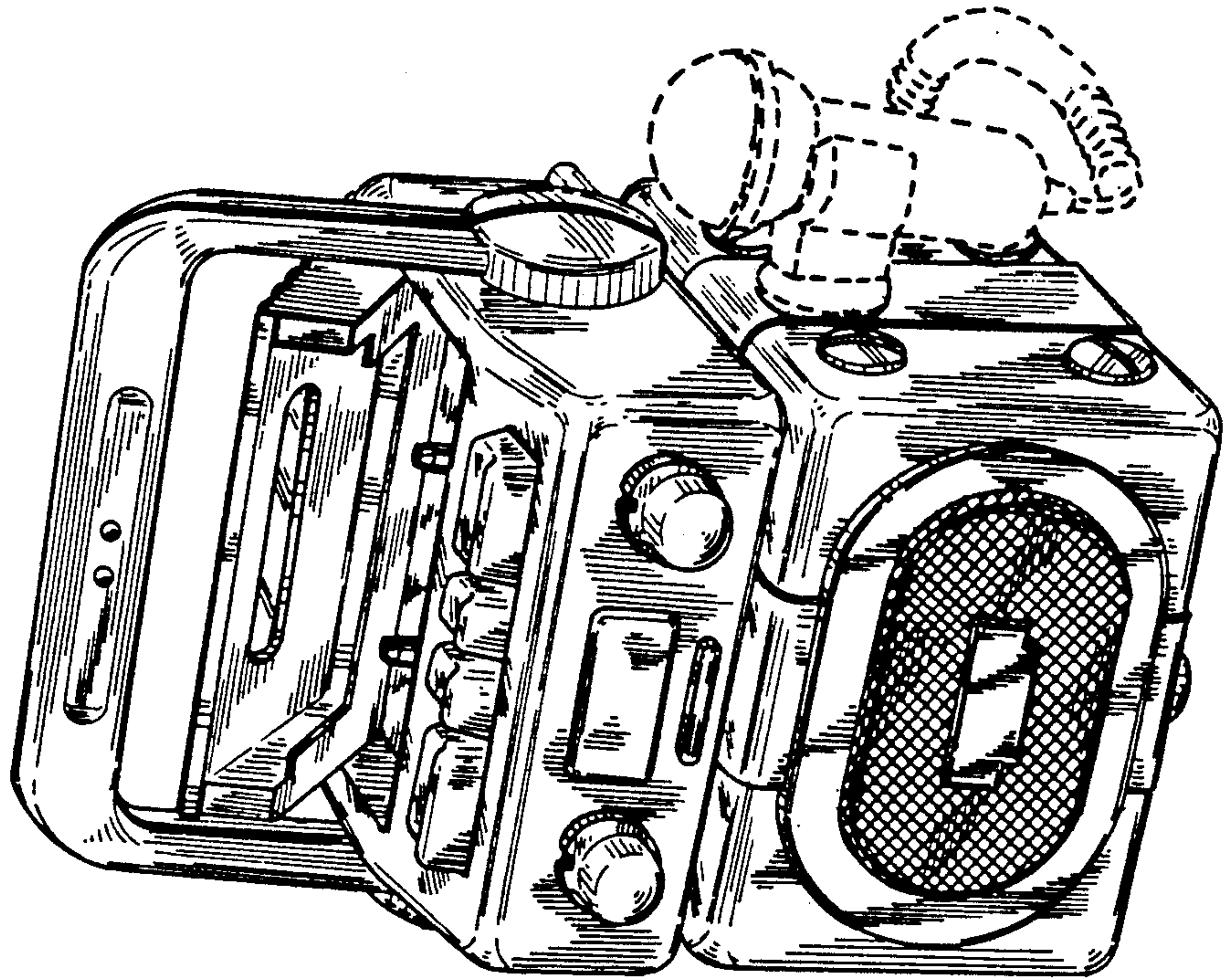

FIG. 1

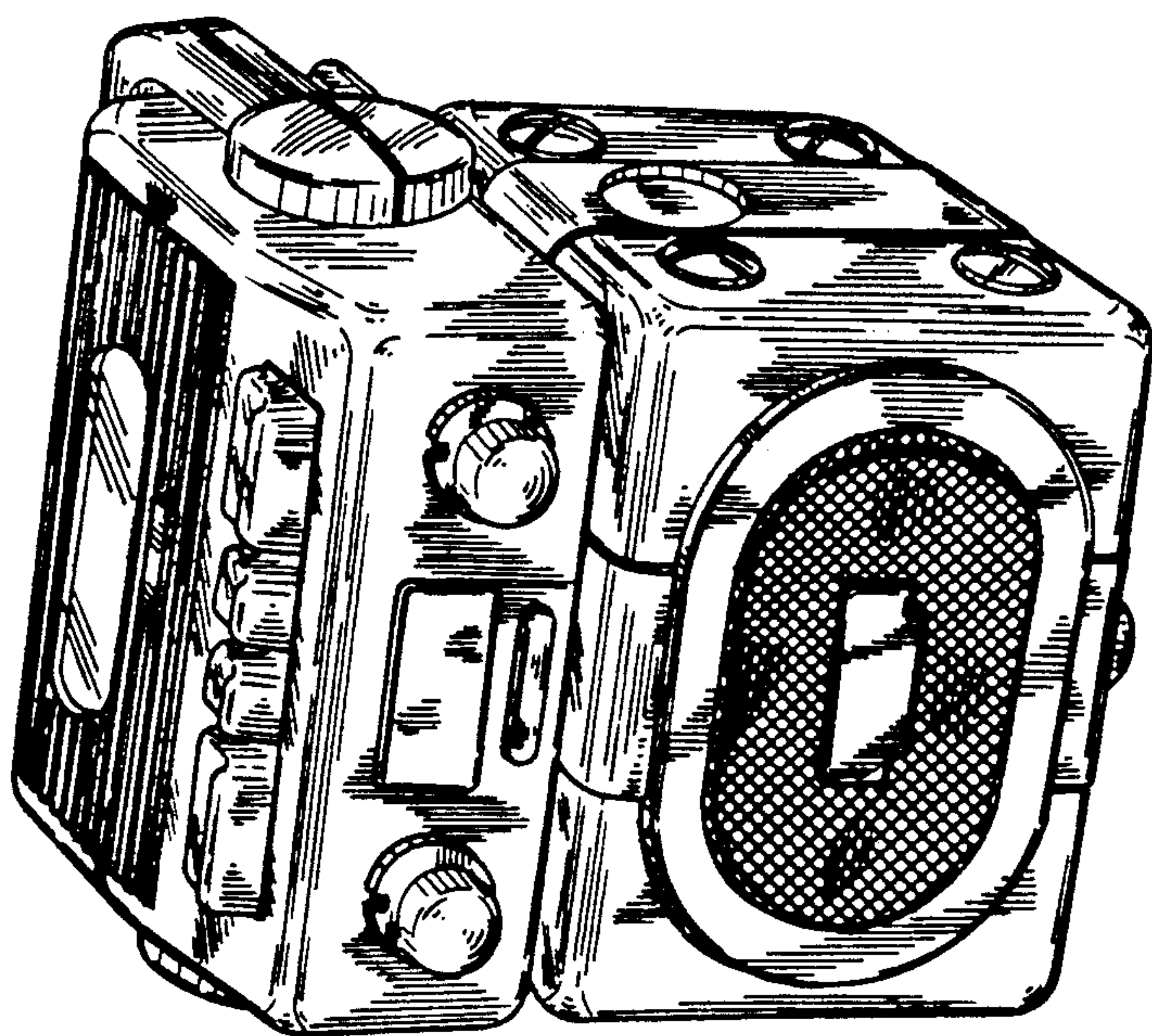

FIG. 3

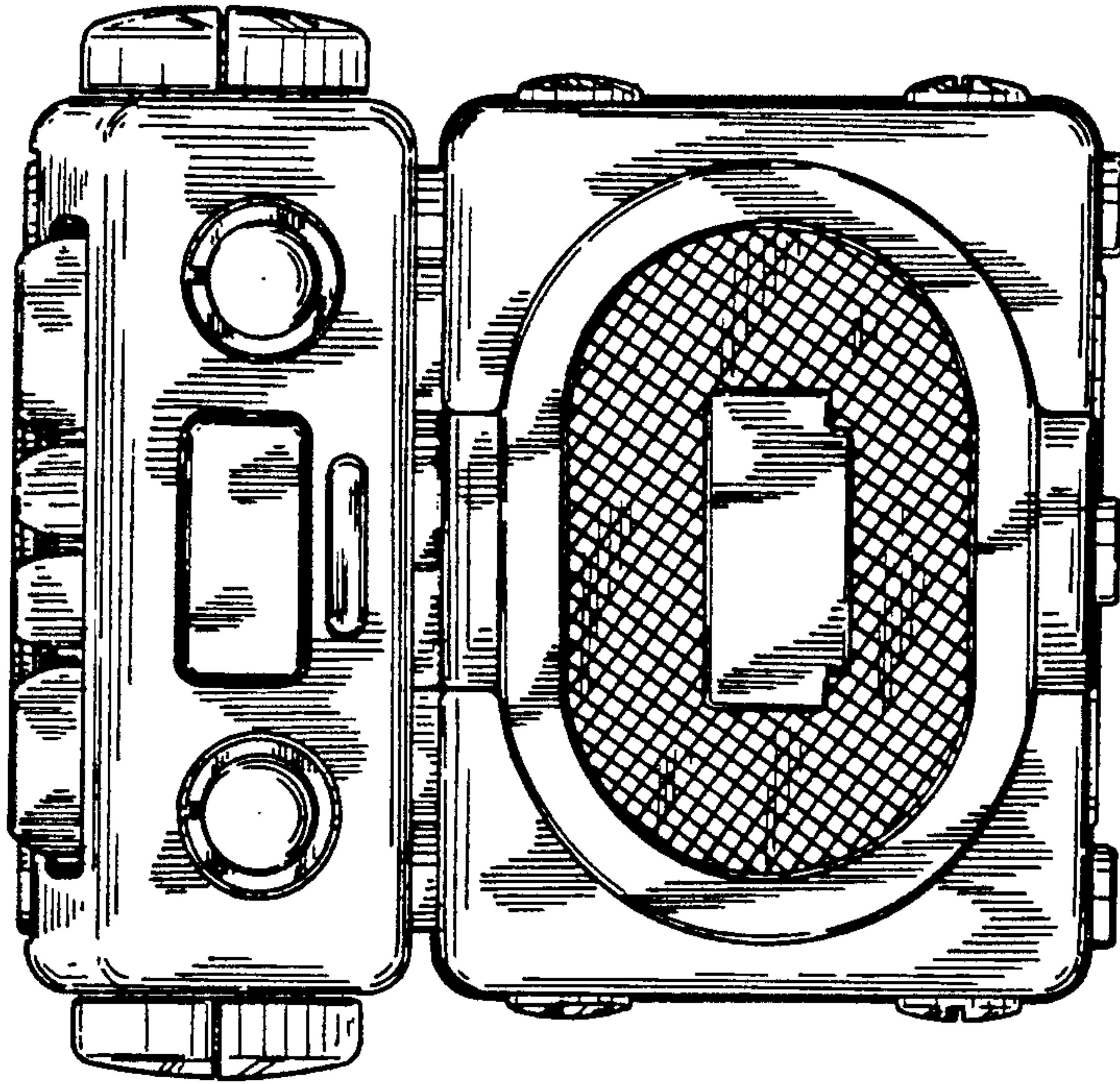

FIG. 4

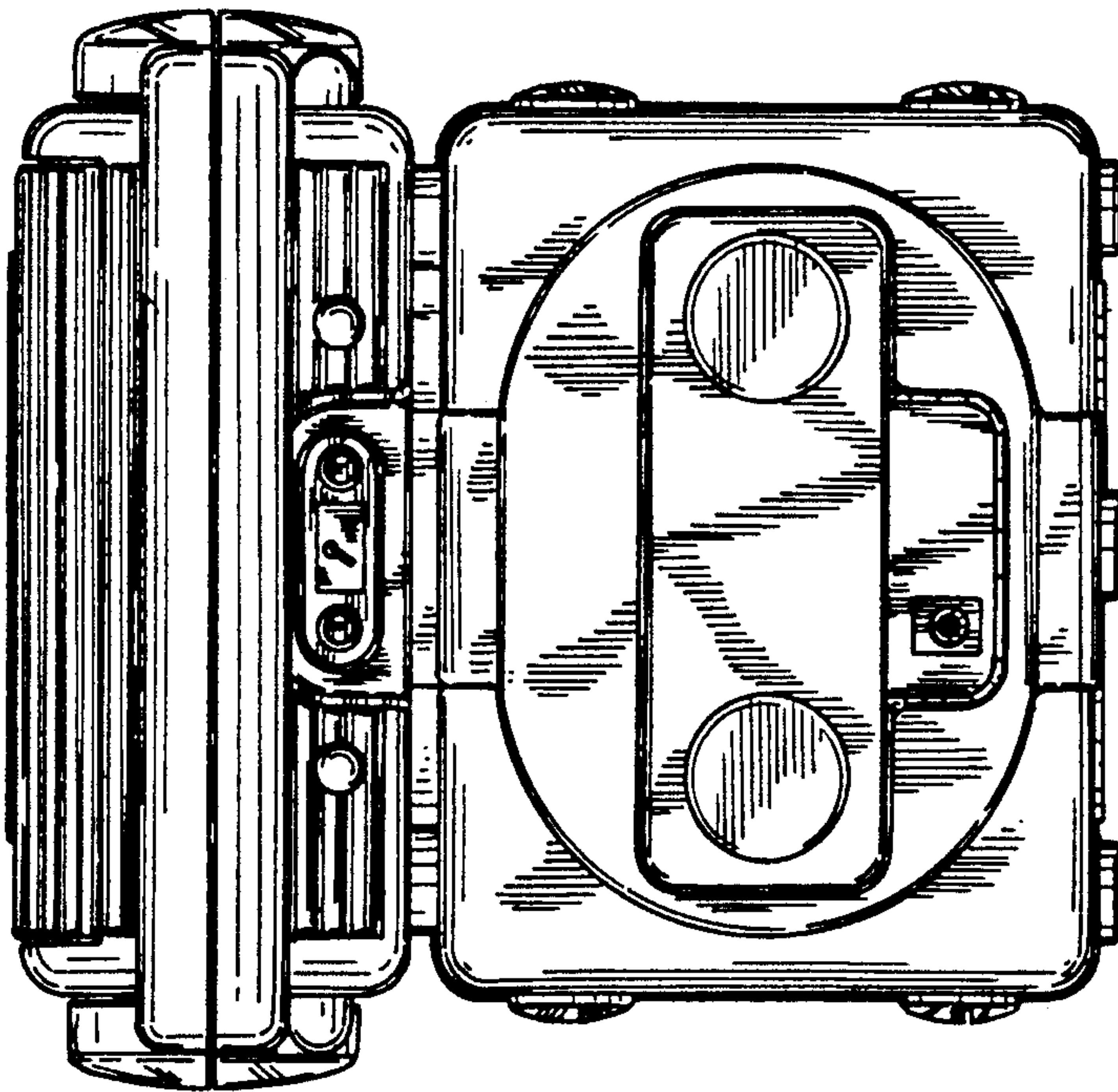

FIG. 6

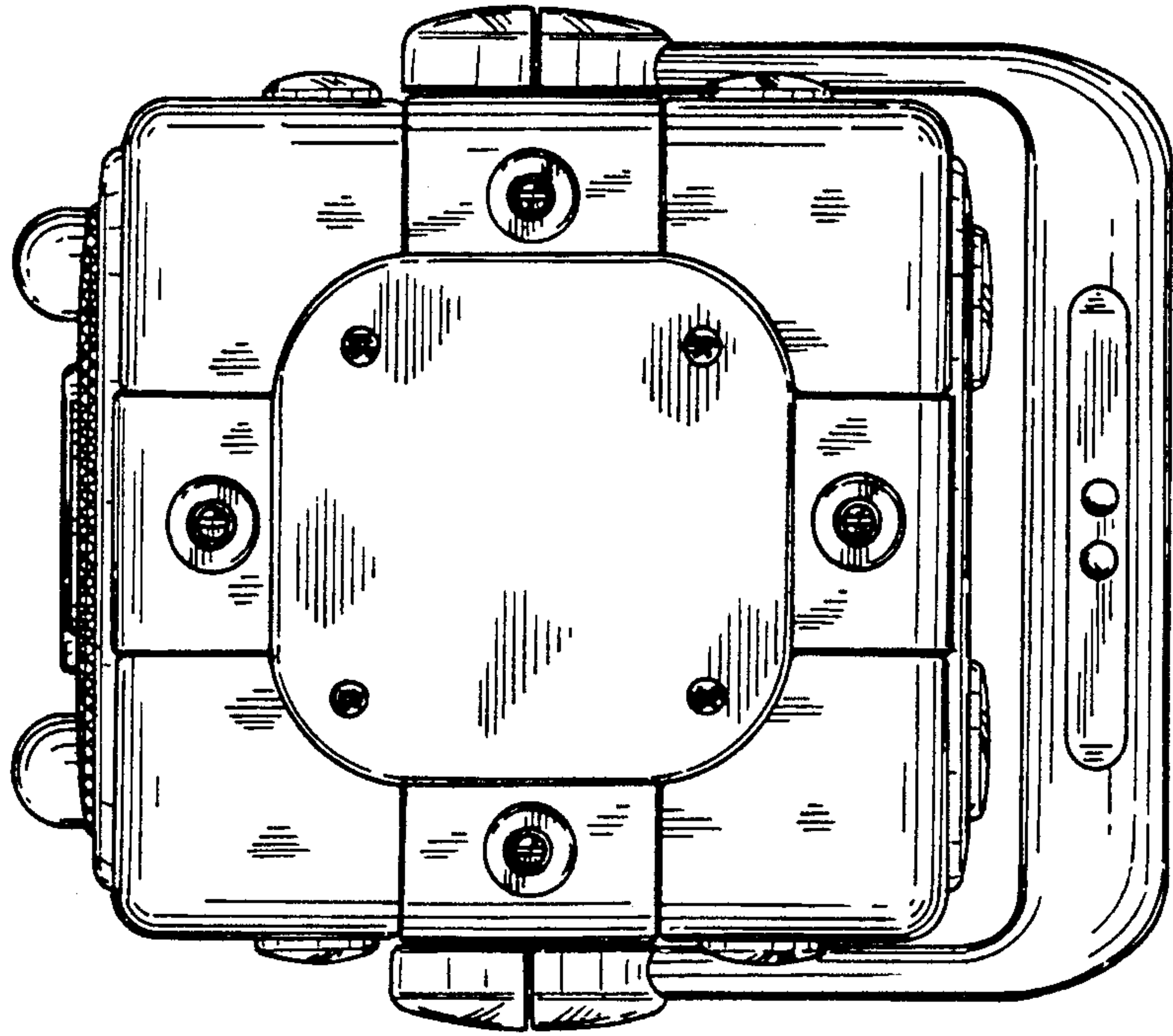

FIG. 5

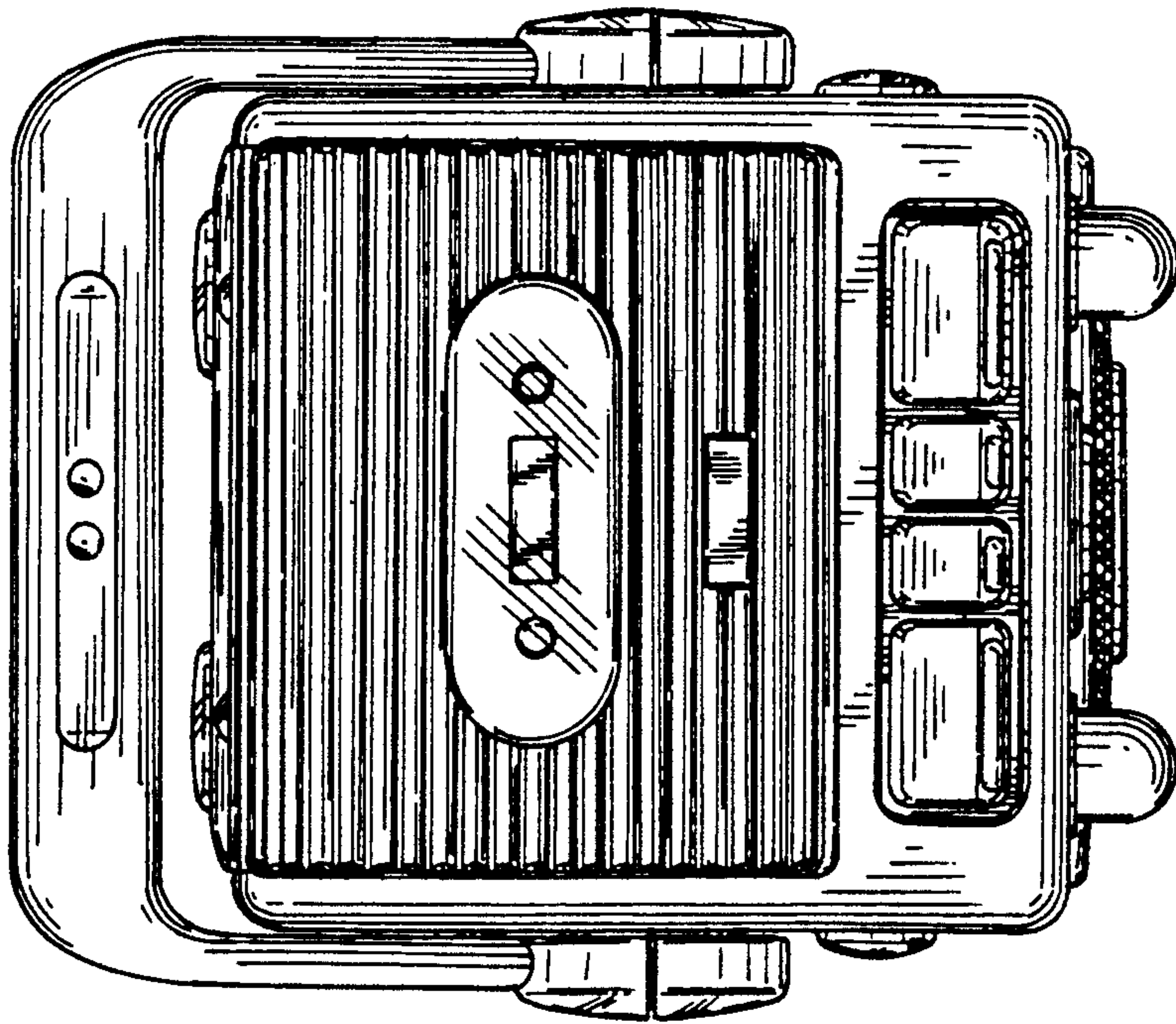

FIG. 8

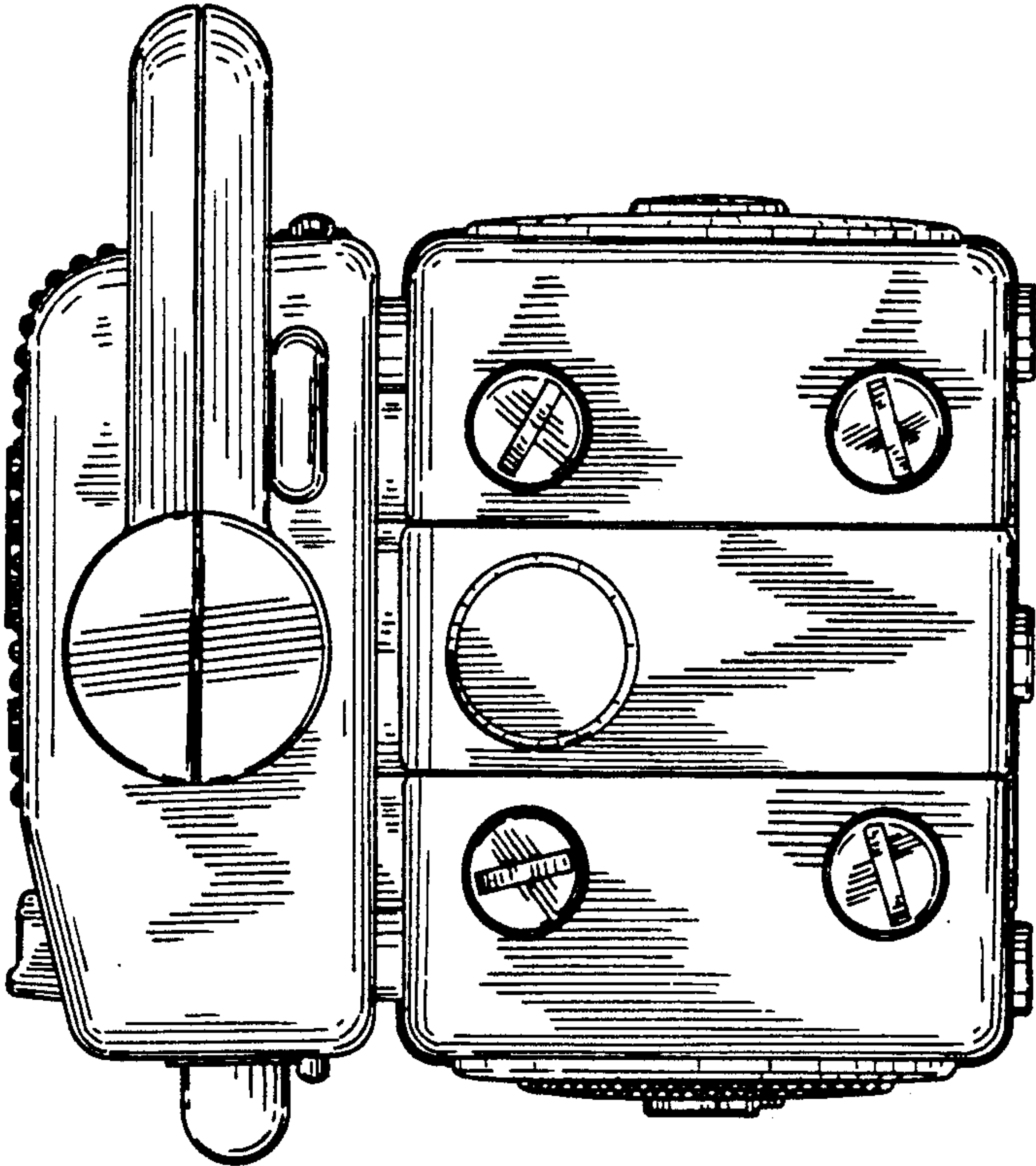

FIG. 7

