

[54] CRADLE OR SIMILAR ARTICLE FOR A TELEPHONE HANDSET

[75] Inventor: Michael G. Langlois, Kanata, Canada

[73] Assignee: U.S. Philips Corporation, New York, N.Y.

[\*\*] Term: 14 Years

[21] Appl. No.: 441,924

[22] Filed: Nov. 27, 1989

[30] Foreign Application Priority Data

Jun. 16, 1989 [GB] United Kingdom ..... 1060240

[52] U.S. Cl. .... D14/151; D14/142; D14/150; D14/148

[58] Field of Search ..... D14/151, 150, 138, 141, D14/142, 140, 248; 379/433, 363, 428, 434, 436, 440

[56] References Cited

U.S. PATENT DOCUMENTS

- D. 245,500 8/1977 Fukushima et al. .... D14/138 X
- D. 261,139 10/1981 Jakobsen ..... D14/151
- D. 274,427 6/1984 Fredrickson ..... D14/138

- D. 287,586 1/1987 Tanaka et al. .... D14/151
- D. 297,732 9/1988 Chan ..... D14/151 X
- D. 298,935 12/1988 Büchin ..... D14/151
- D. 302,690 8/1989 Krohn et al. .... D14/151 X
- 4,736,411 4/1988 Chan ..... D14/151 X
- 4,821,320 4/1989 Ardent et al. .... 379/433 X

FOREIGN PATENT DOCUMENTS

0072261 4/1984 Japan ..... 379/449

Primary Examiner—Horace B. Fay, Jr.

Attorney, Agent, or Firm—Jack E. Haken

[57] CLAIM

The ornamental design for a cradle or similar article for a telephone handset, as shown.

DESCRIPTION

FIG. 1 is a front, top and right side perspective view of a cradle or similar article for a telephone handset showing my new design;

FIG. 2 and 3 are respectively top and bottom plan views thereof;

FIG. 4 and 5 are respectively front and rear end elevational views thereof; and

FIG. 6 and 7 are respectively right and left elevational side view thereof.

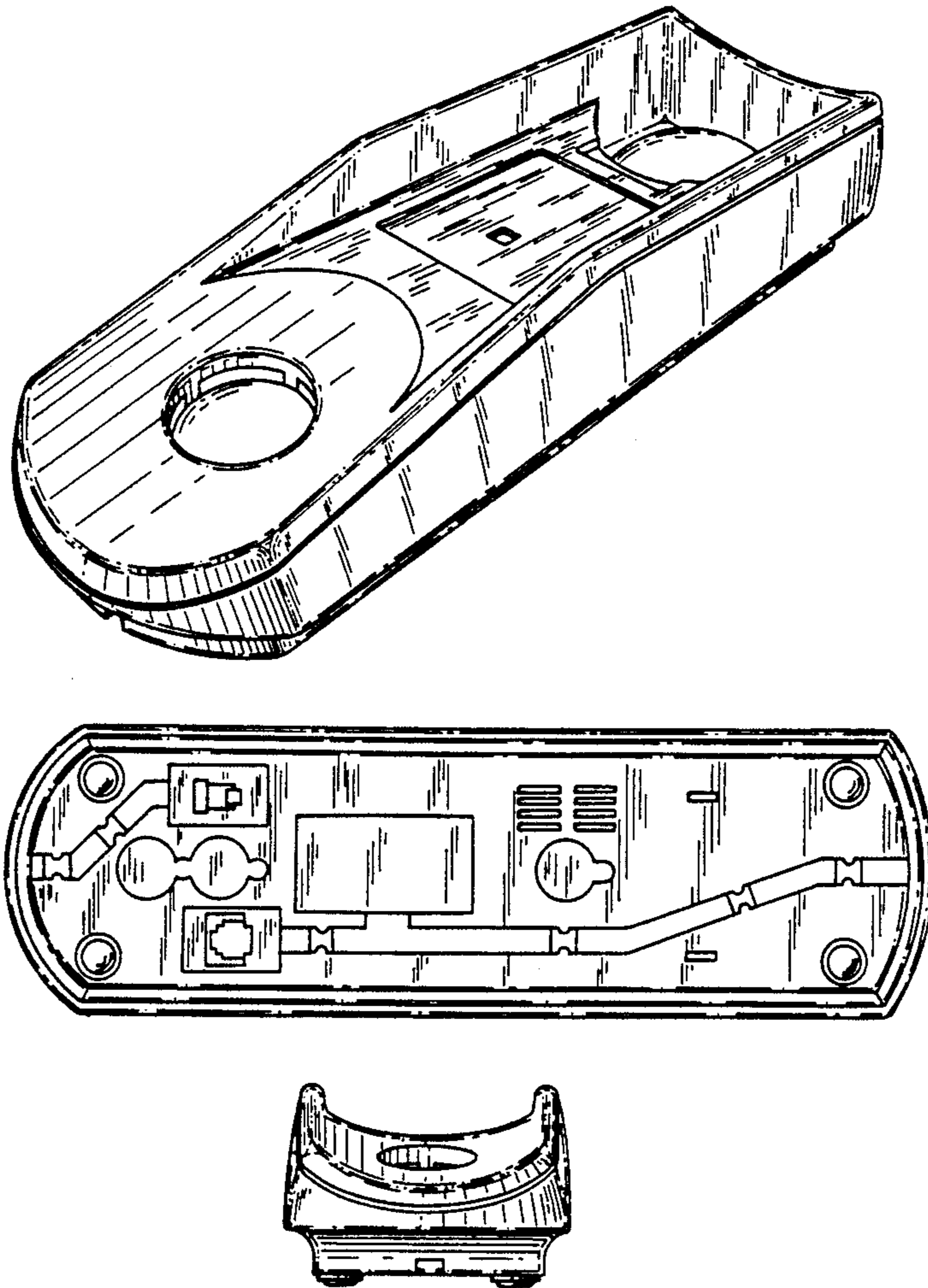

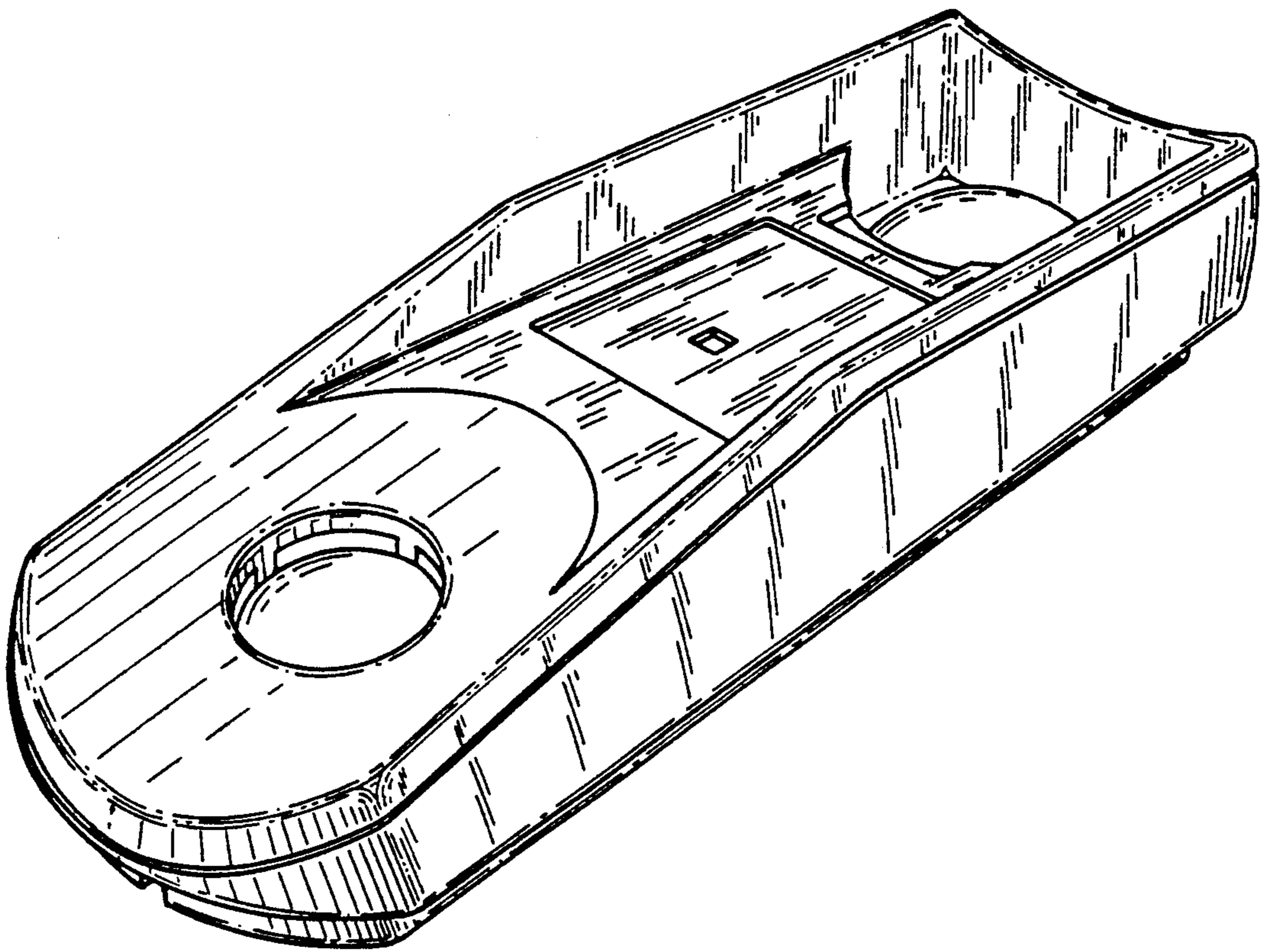

1

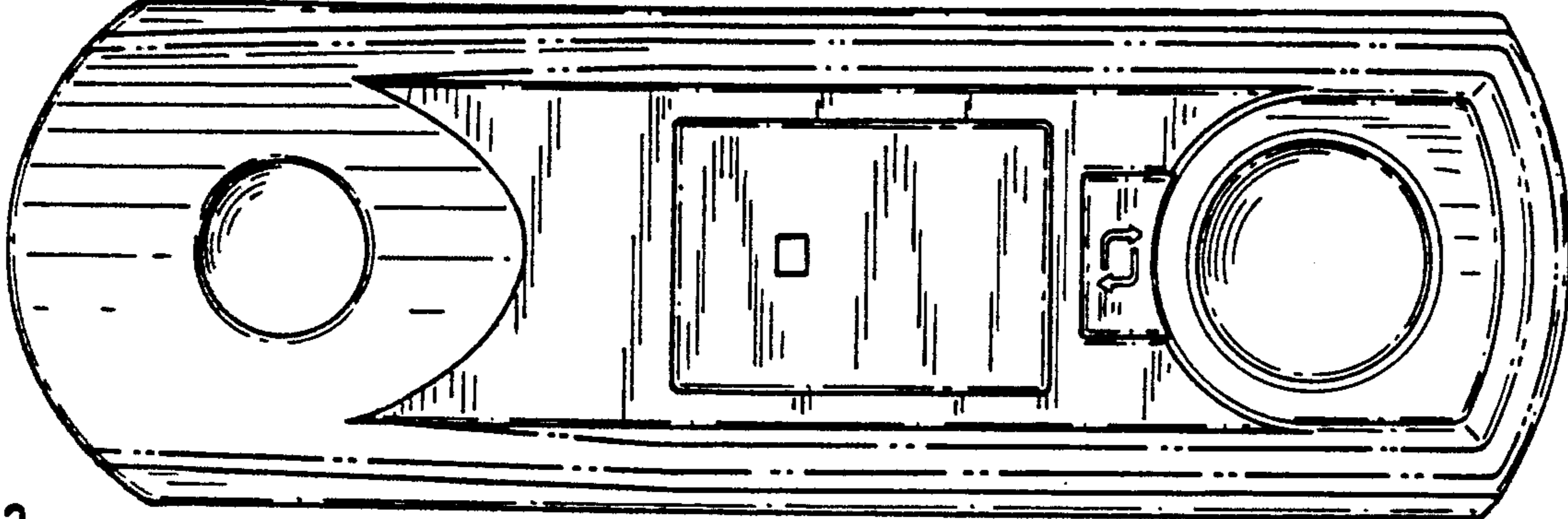

2

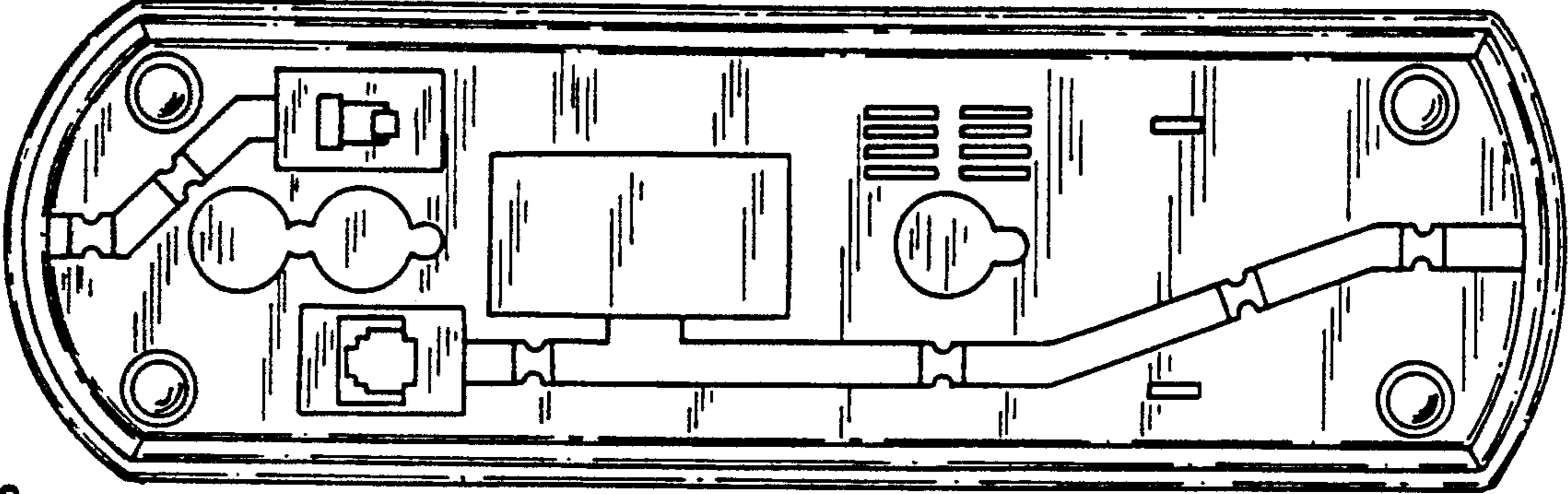

3

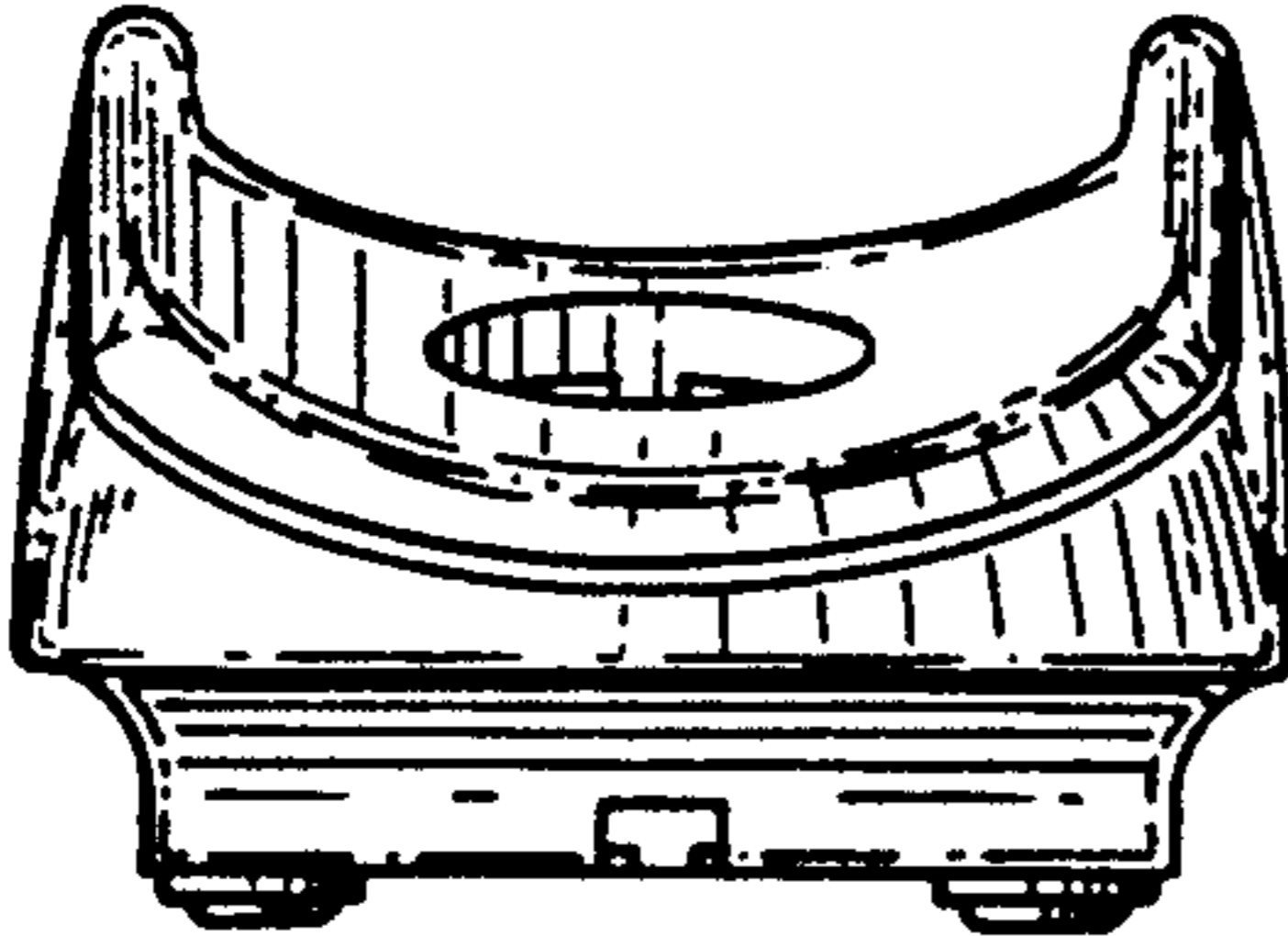

4

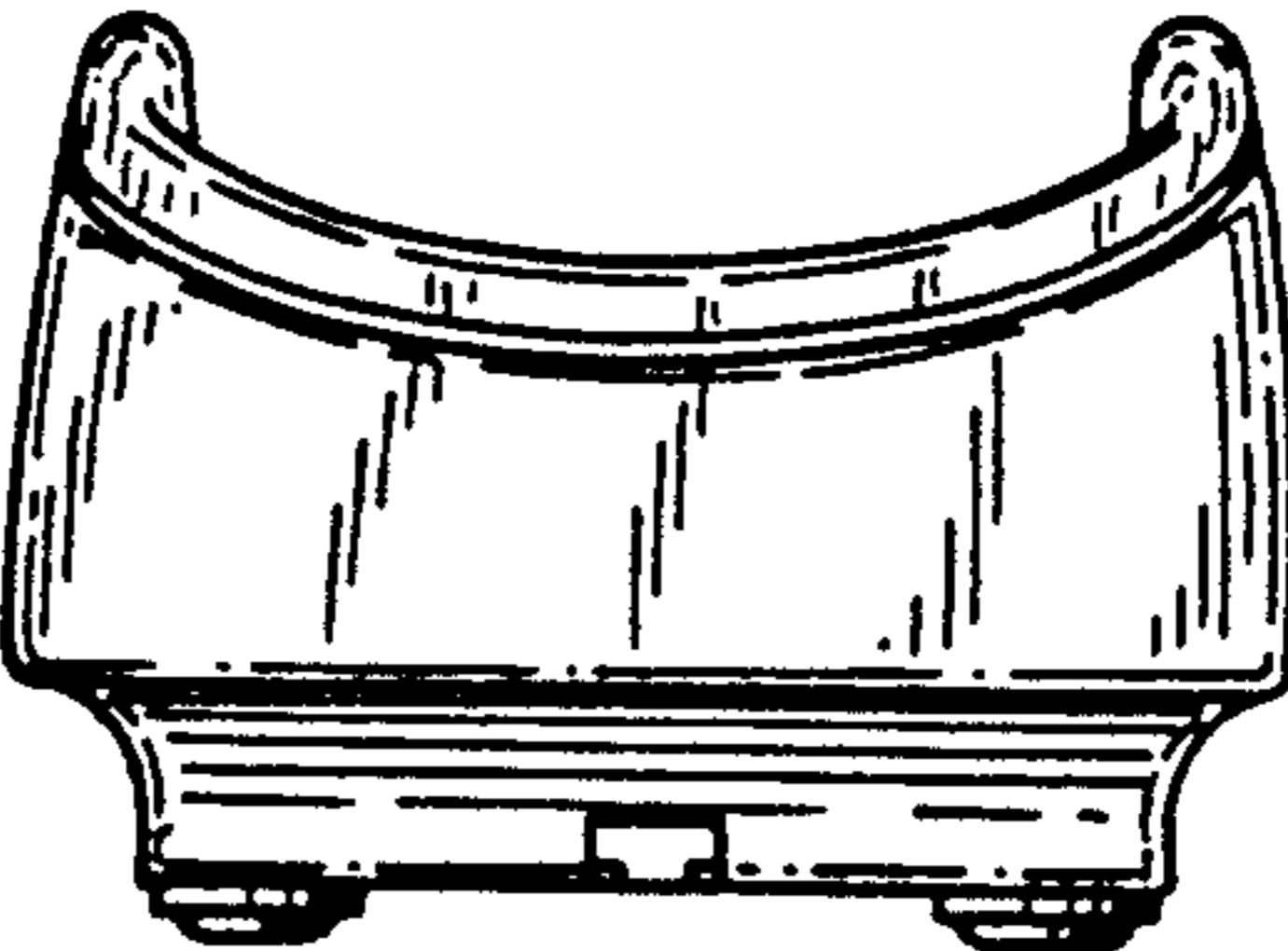

5



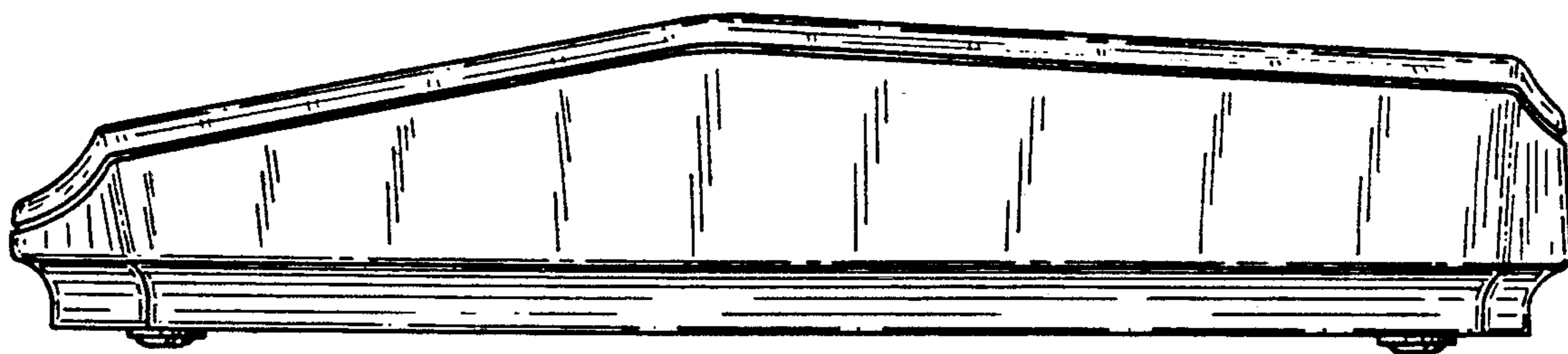

6

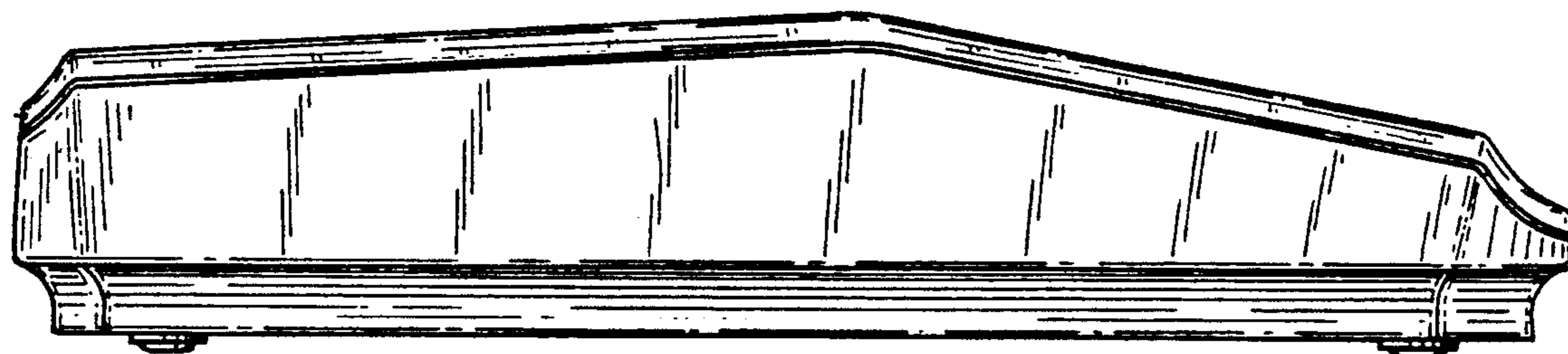

7