

[54] DISPLAY UNIT FOR COUNTER SALES

4,819,802 4/1989 Gutierrez 312/13 X

[76] Inventor: Marvin Zaro, 6 Woodland Rd., Bordentown, N.J. 08505

Primary Examiner—Bruce W. Dunkins
Assistant Examiner—Monica A. Hannon
Attorney, Agent, or Firm—Charles I. Brodsky

[**] Term: 14 Years

[21] Appl. No.: 334,399

[57] CLAIM

[22] Filed: Apr. 7, 1989

The ornamental design for a display unit for counter sales, as shown and described.

[52] U.S. Cl. D6/468; D6/396; D6/467; D3/35

DESCRIPTION

[58] Field of Search D6/468, 467, 411, 498, D6/407; 206/73, 309, 387, 15, 444; 312/10-15; 211/13, 441; D32/21; D19/76

FIG. 1 is a front perspective view of a display unit for counter display showing my new design; FIG. 2 is a front elevational view of a display unit for counter display showing my design; FIG. 3 is a rear elevational view of such display unit; FIG. 4 is a right side elevational view thereof; FIG. 5 is a left side elevational view thereof; FIG. 6 is a top plan view of a display unit showing my new design; and FIG. 7 is a bottom plan view thereof.

[56] References Cited

U.S. PATENT DOCUMENTS

- D. 161,815 2/1951 Beeman D6/467 X
- D. 287,544 1/1987 Long et al. D19/76 X
- D. 287,547 1/1987 Rager D3/35
- 4,180,921 1/1980 Elbaum et al. 211/13 X

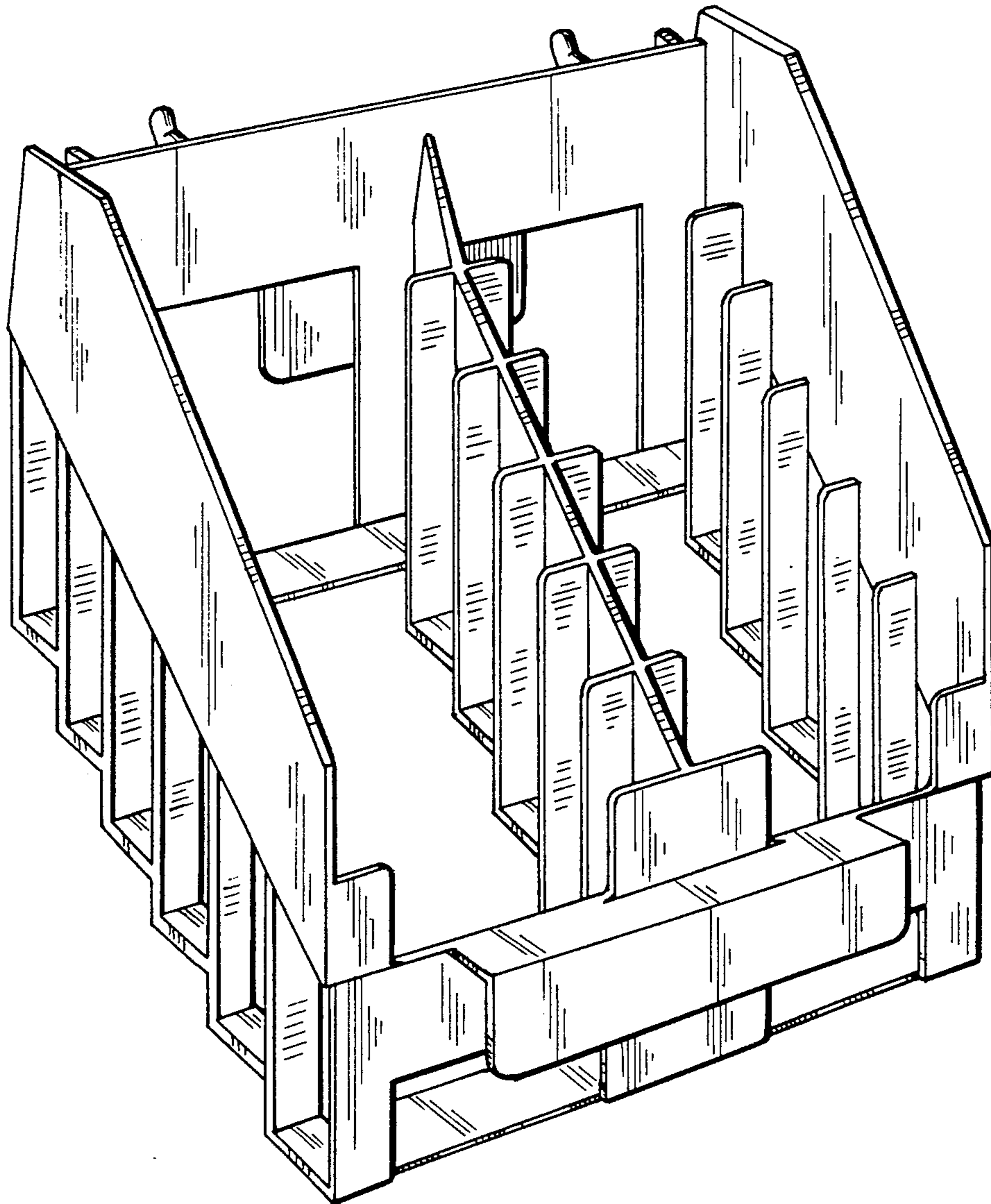

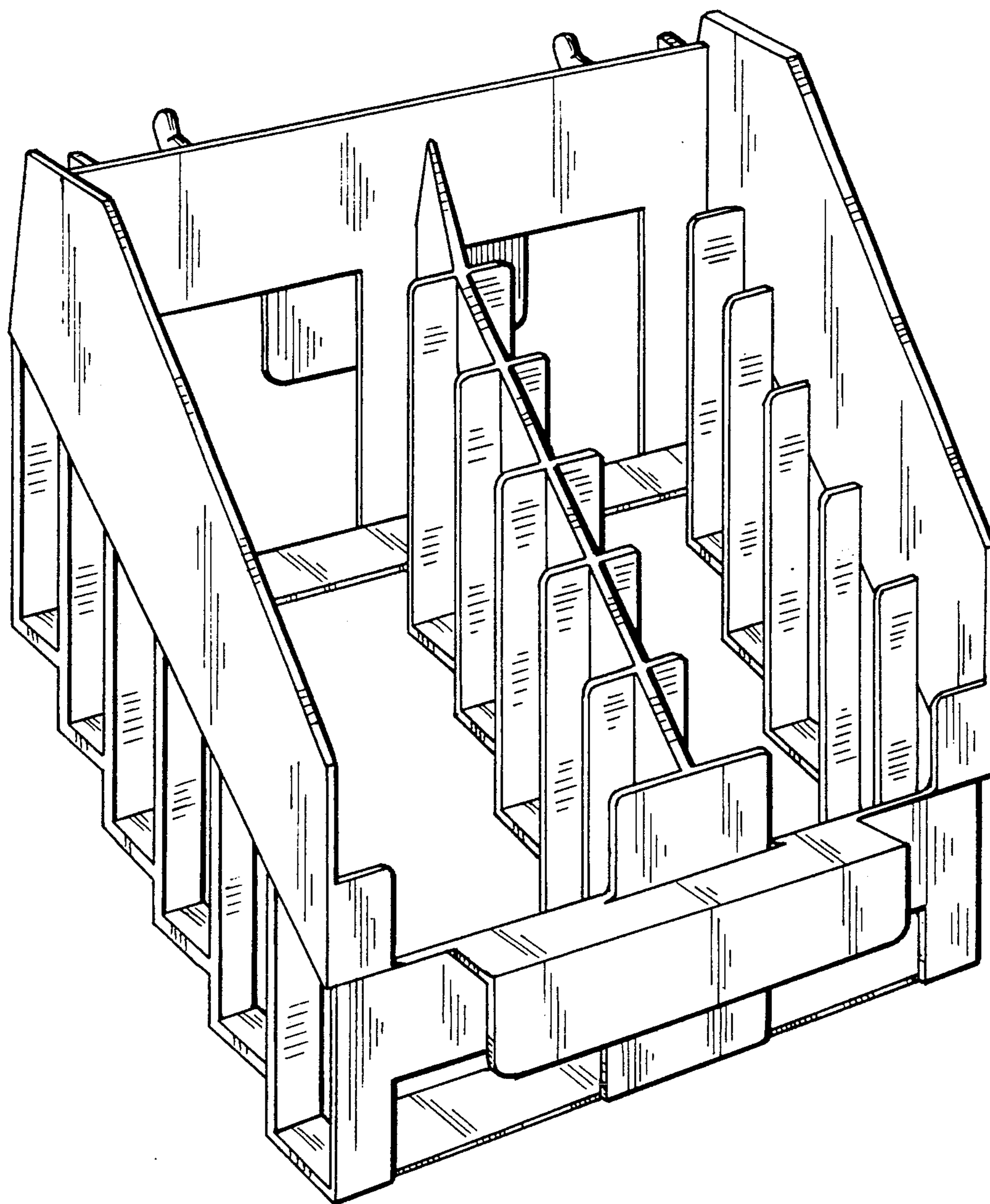

FIG. 1

FIG. 2

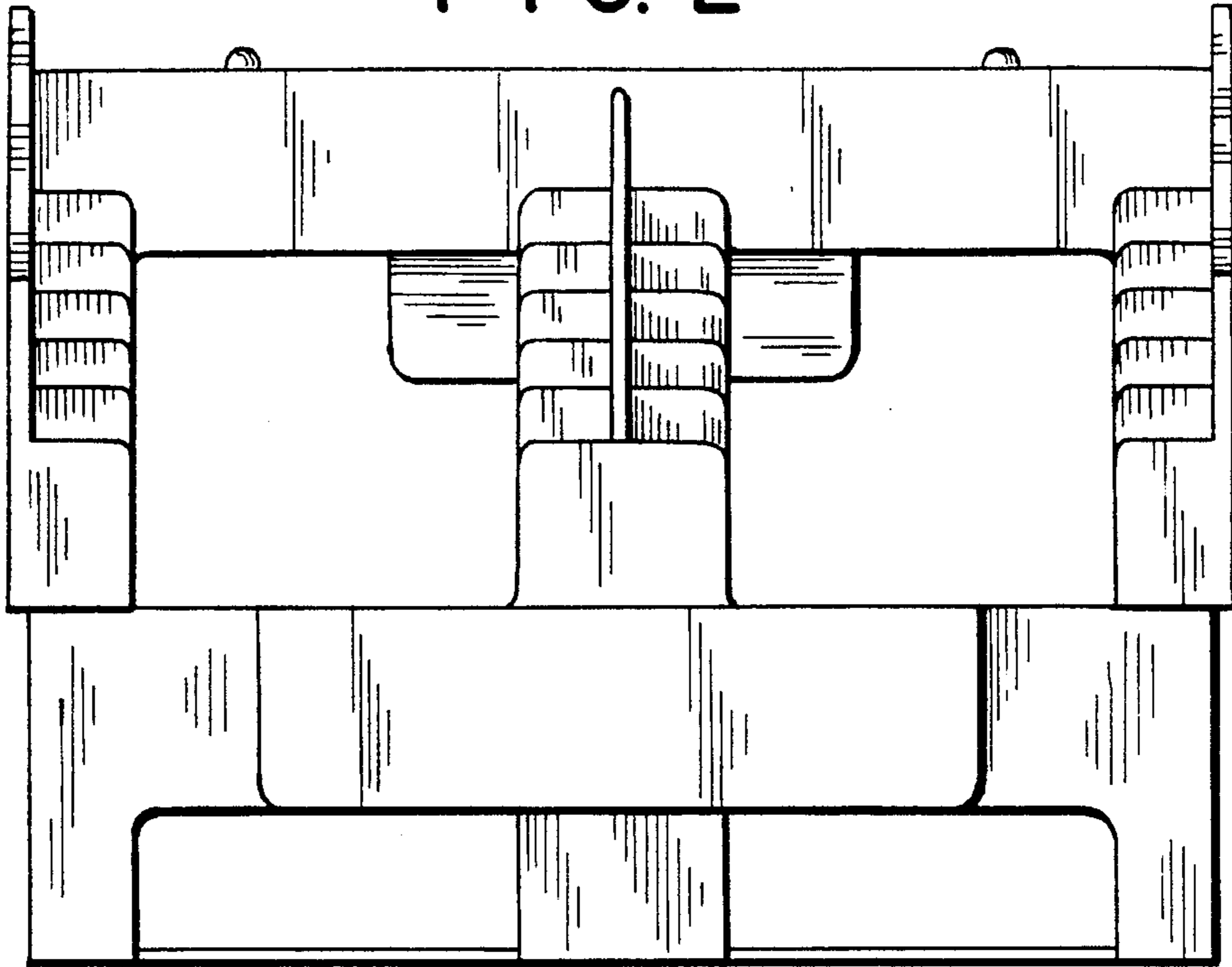

FIG. 3

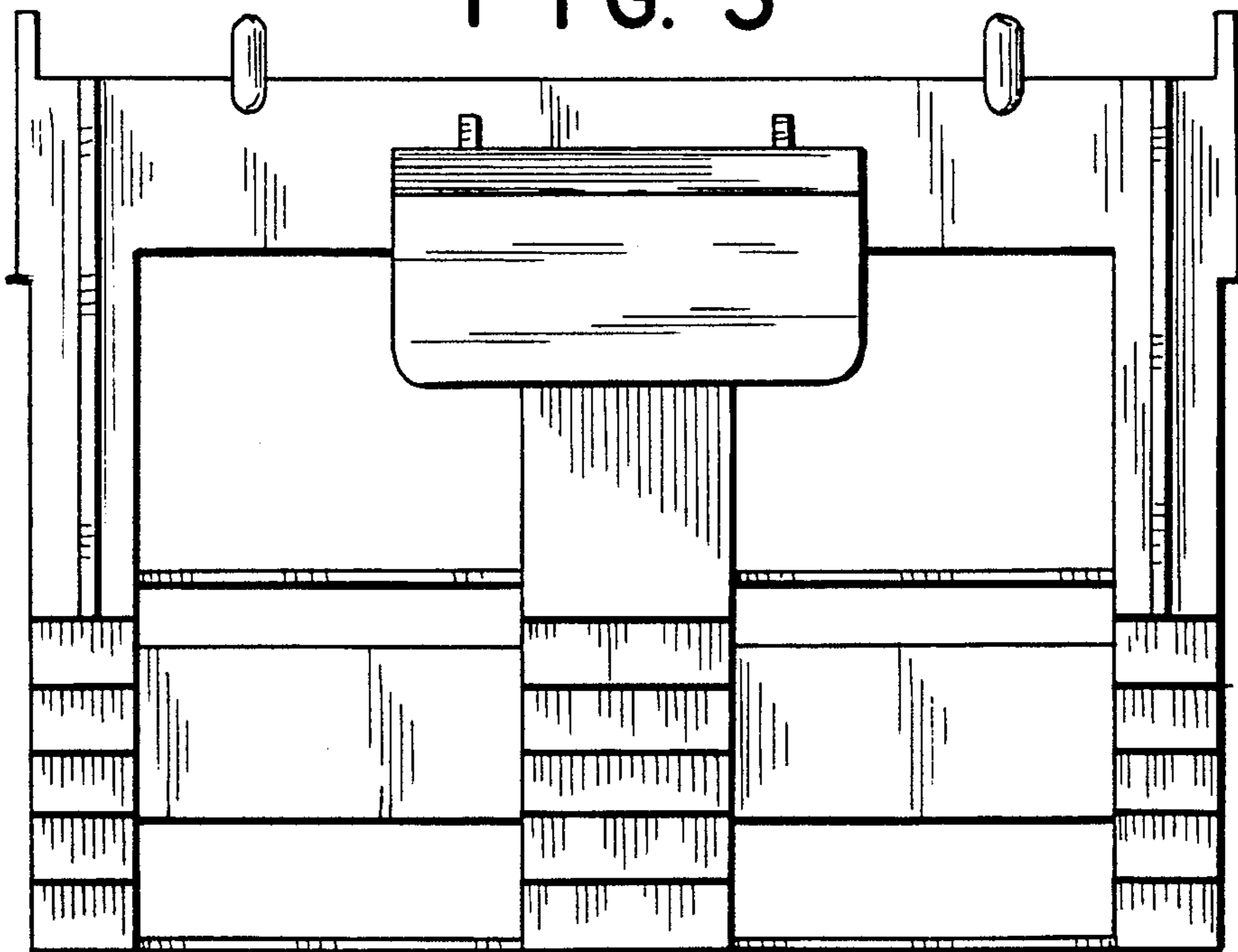

FIG. 4

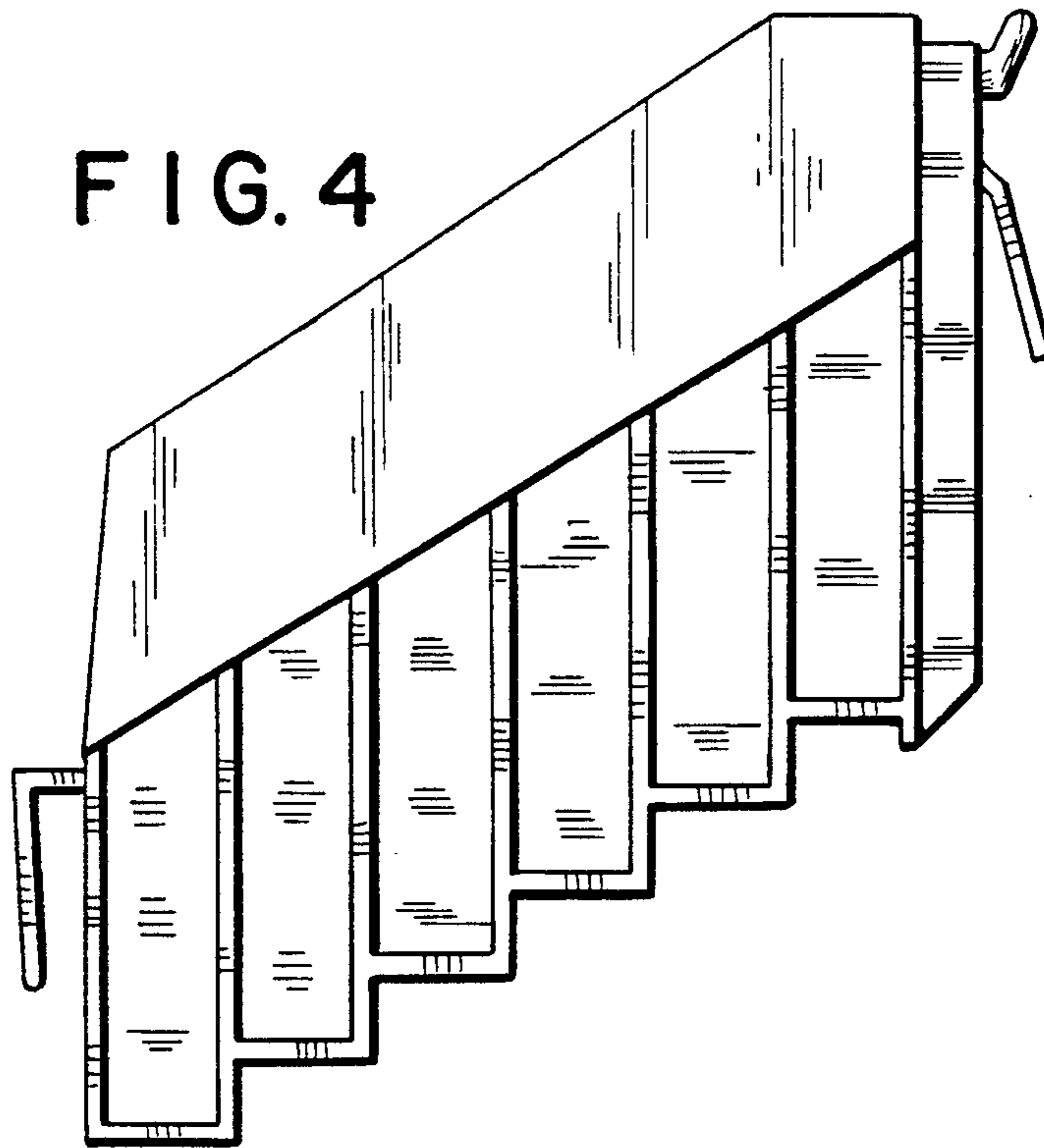

FIG. 5

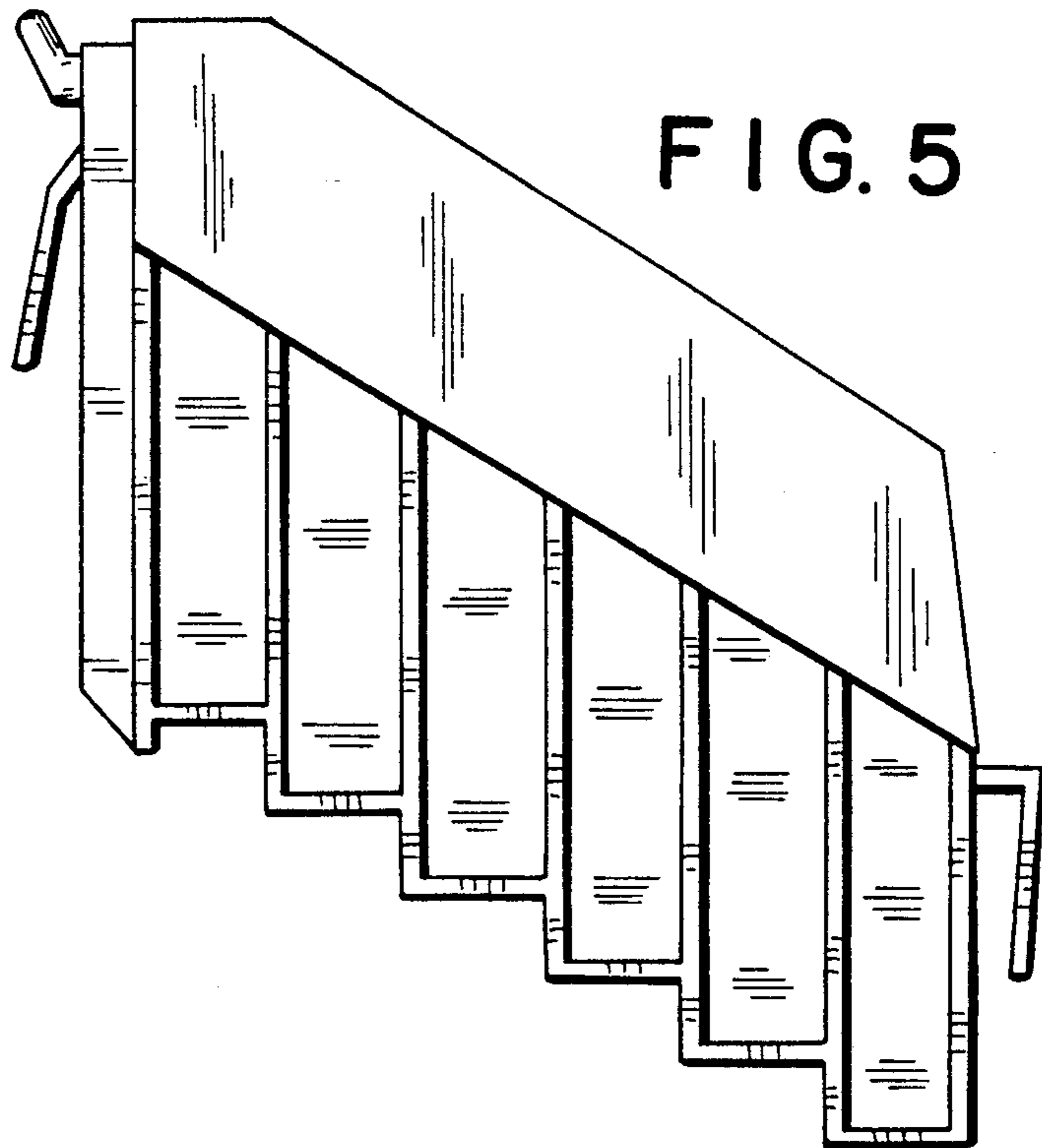

FIG. 6

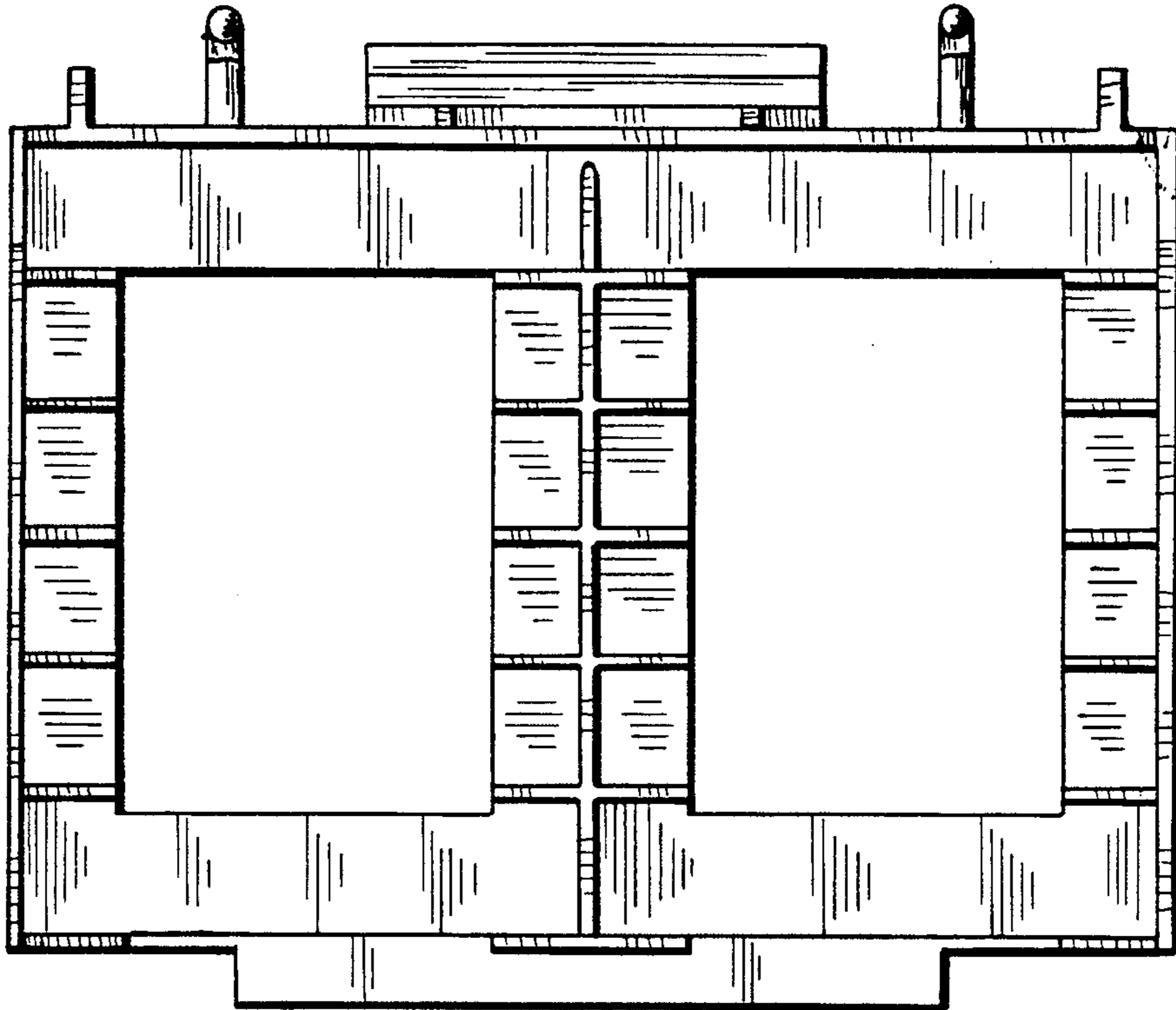

FIG. 7

