

[54] CURLING IRON

[75] Inventors: James G. Montagnino; Betty Butzko; Daniel Santhouse; Tim Hanlon; Steve Power, all of El Paso, Tex.

[73] Assignee: Helen of Troy, El Paso, Tex.

[**] Term: 14 Years

[21] Appl. No.: 466,697

[22] Filed: Jan. 17, 1990

[52] U.S. Cl. D28/35

[58] Field of Search D28/35; 219/222-225, 219/533; 132/223, 226-229, 232, 263, 268, 269

[56] References Cited

U.S. PATENT DOCUMENTS

D. 261,692	11/1981	O'Brien	D28/35
D. 264,258	5/1982	Zago	D28/35
D. 269,555	6/1983	Peterson et al.	D28/35
4,604,514	8/1986	Thaler et al.	132/232 X

OTHER PUBLICATIONS

Modern Beauty Shop 8/1968 p. 97: right center Mini Babyliss Curling Iron.

Hong Kong Enterprise, 3/1986, p. 357: lower left Quadrant-#PT-713 and #PT-719.

Modern Salon 2/1988 (The Guide) p. 152: Monsieur Charles Marcel Iron.

Primary Examiner—Bernard Ansher
Assistant Examiner—C. Tuttle
Attorney, Agent, or Firm—Watson, Cole, Grindle & Watson

[57] CLAIM

The ornamental design for a curling iron, as shown and described.

DESCRIPTION

FIG. 1 is a right side elevational view of a curling iron showing our new design;
FIG. 2 is a top plan view thereof;
FIG. 3 is a left side elevational view thereof;
FIG. 4 is a bottom plan view thereof;
FIG. 5 is a front end elevational view thereof;
FIG. 6 is a rear end elevational view thereof;
FIG. 7 is a right side elevational view of a second modified embodiment, the side opposite being a mirror image of the side shown; and
FIG. 8 is a right side elevational view of a third modified embodiment, the side opposite being a mirror image of the side shown.

The cord portion of the design is shown fragmentarily in the various views to indicate indeterminate length.

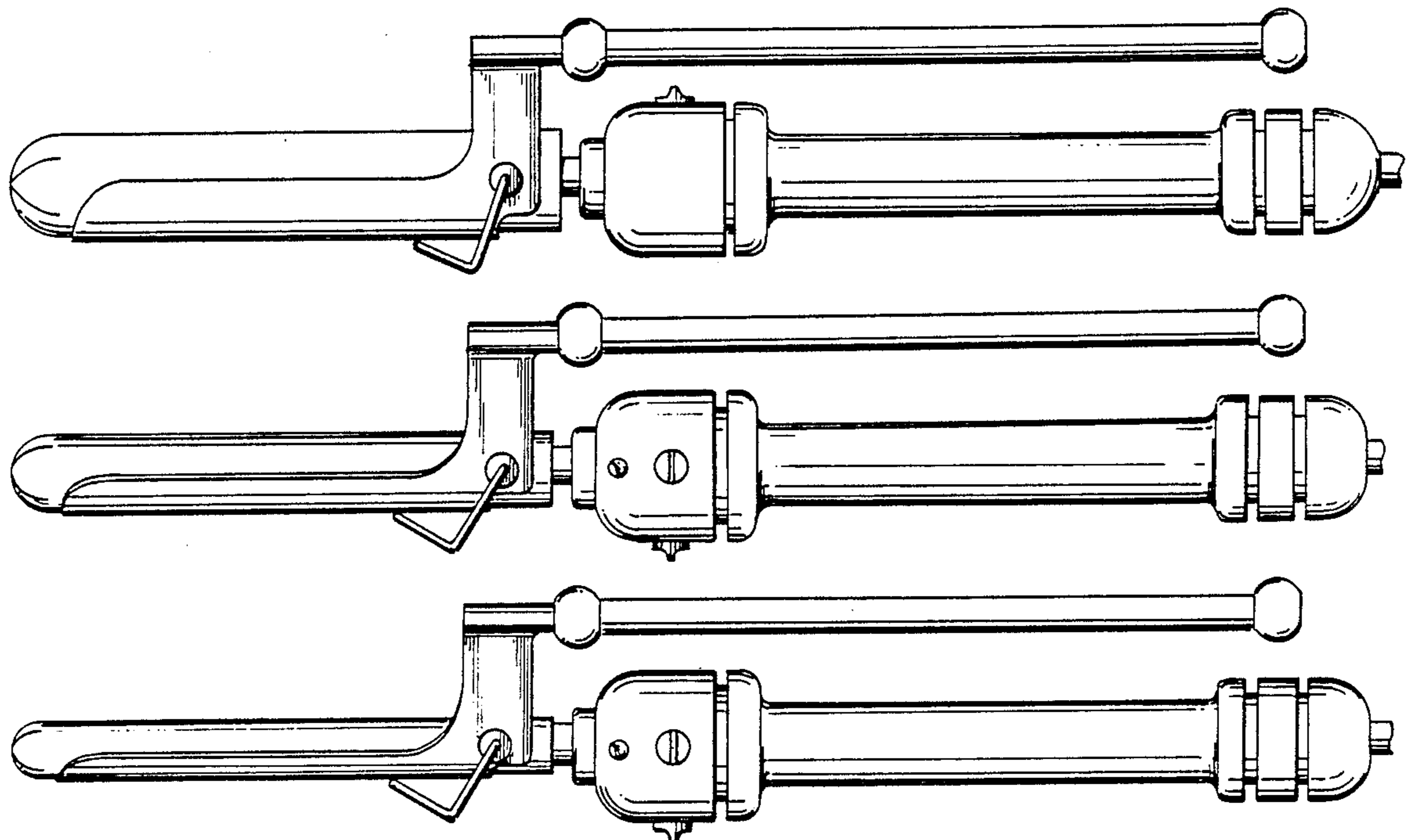

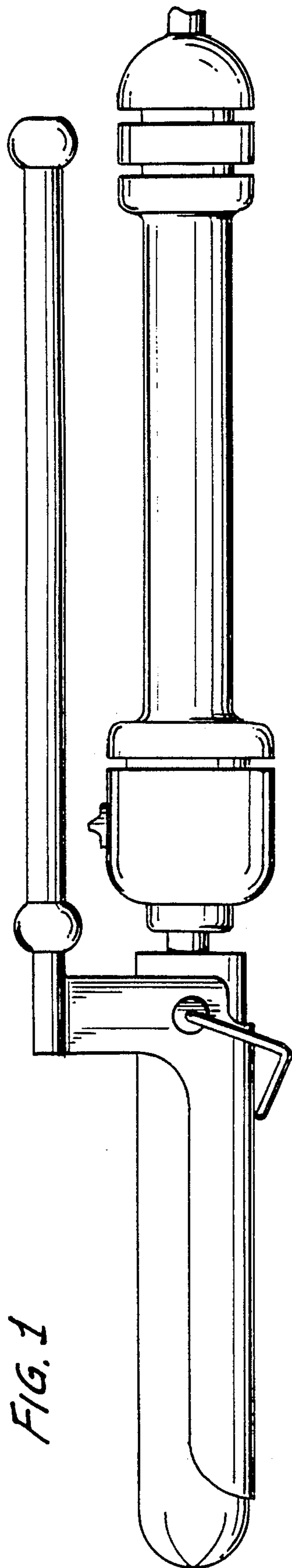

FIG. 2

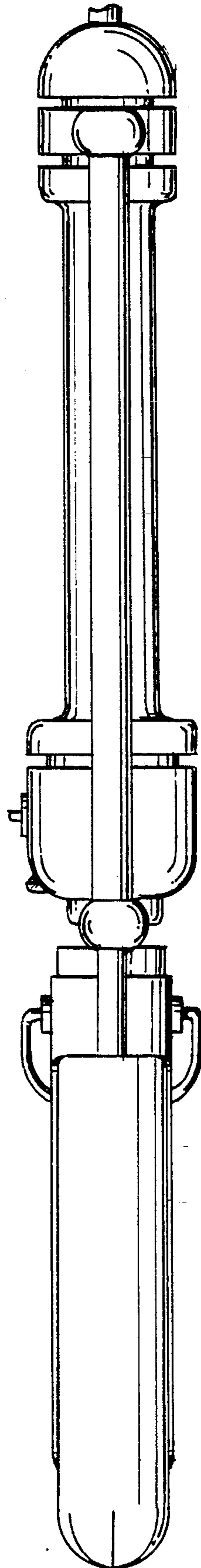
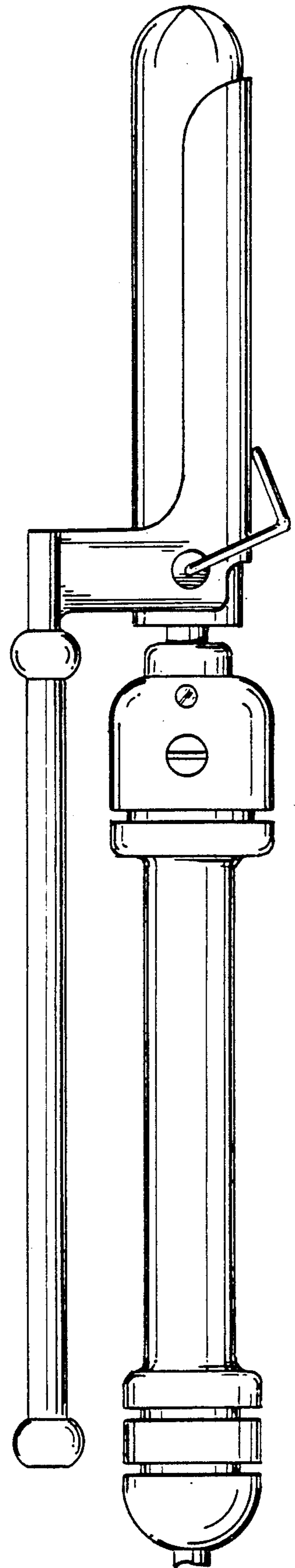

FIG. 3



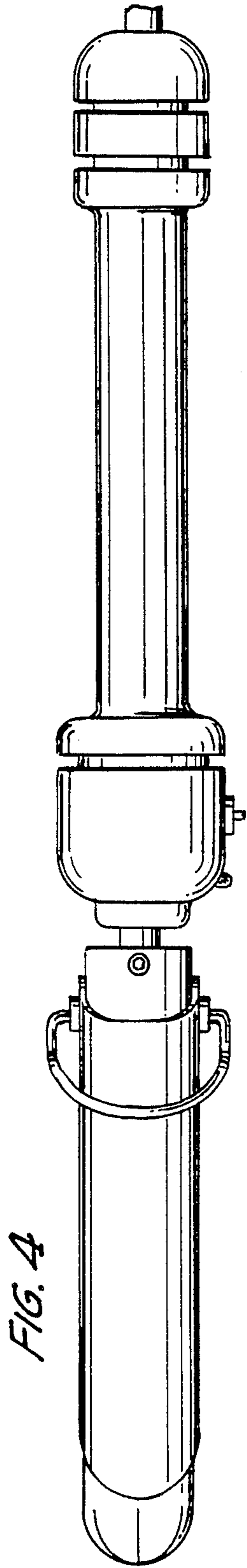

FIG. 5

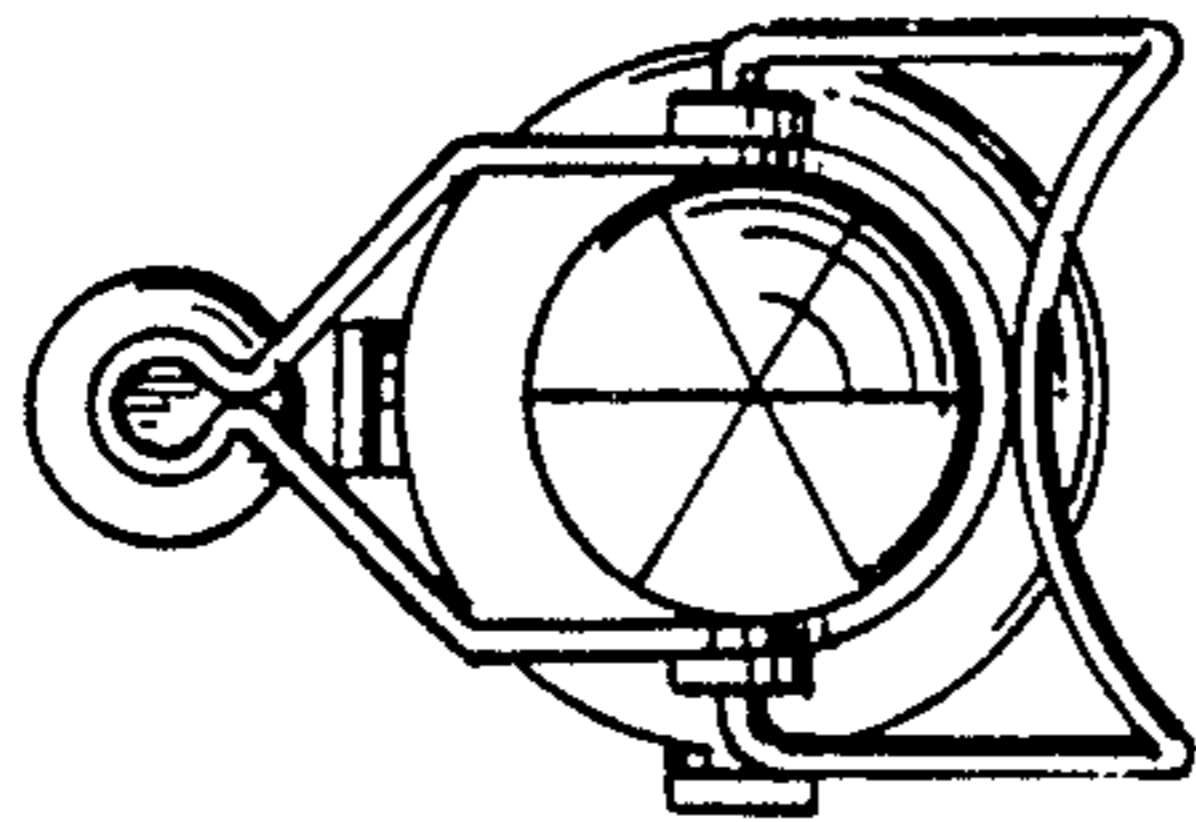

FIG. 6

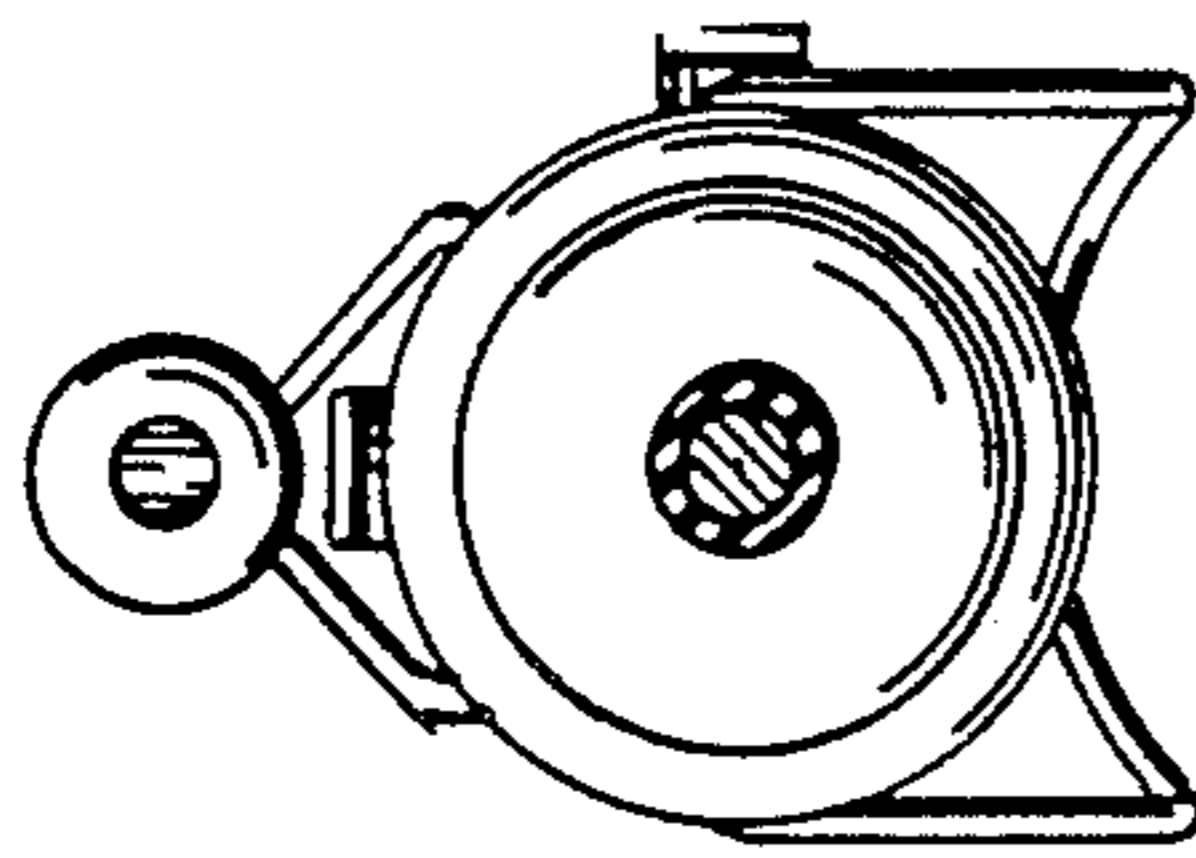

FIG. 7

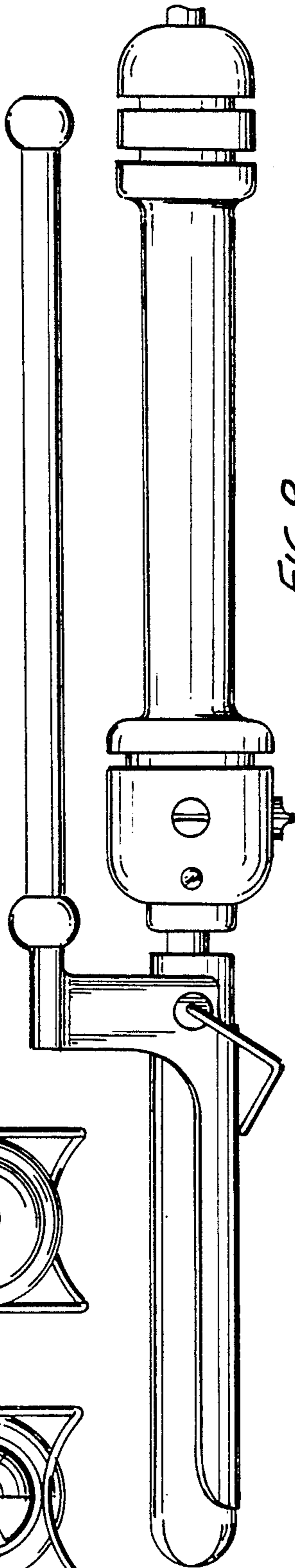

FIG. 8

