

[54] WINDSHIELD STICKER HOLDER

4,953,315 9/1990 Romaine ..... 40/597

[76] Inventors: Van Whitlock; Shirley Whitlock, both of 811 Forest Green Dr., Corapolis, Pa. 15108

Primary Examiner—Wallace R. Burke  
Assistant Examiner—Marcus Jackson  
Attorney, Agent, or Firm—Terry M. Gernstein

[\*\*] Term: 14 Years

[57] CLAIM

[21] Appl. No.: 356,397

The ornamental design for a windshield sticker holder, as shown and described.

[22] Filed: May 25, 1989

[52] U.S. Cl. .... D20/42

DESCRIPTION

[58] Field of Search ..... D20/10, 22, 23, 27, D20/29, 42; 211/47, 48, 96, 168; 40/336, 337, 338, 339, 490, 493, 584, 591, 594, 597, 600, 661

FIG. 1 is a perspective view of a windshield sticker holder showing my new design;  
FIG. 2 is a right side elevational view thereof;  
FIG. 3 is a left side elevational view thereof;  
FIG. 4 is a top plan view thereof;  
FIG. 5 is a front elevational view thereof;  
FIG. 6 is a rear elevational view thereof;  
FIG. 7 is a bottom plan view thereof;  
FIG. 8 is a perspective view of a second embodiment.

[56] References Cited

U.S. PATENT DOCUMENTS

D. 303,403	9/1989	Bascom	.....	D20/43
D. 304,737	11/1989	Mori	.....	D20/42
1,856,519	5/1932	Spears	.....	40/597

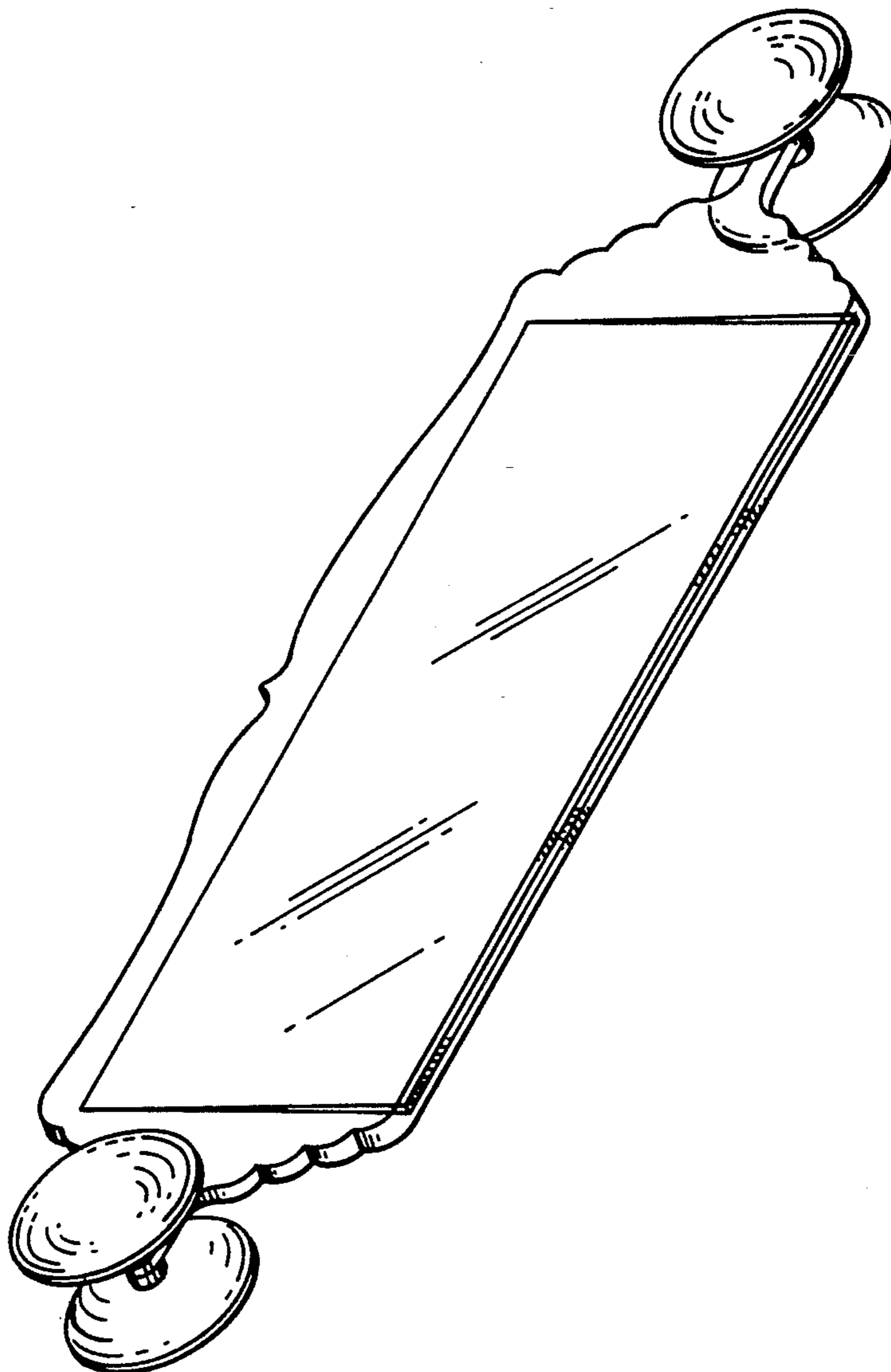

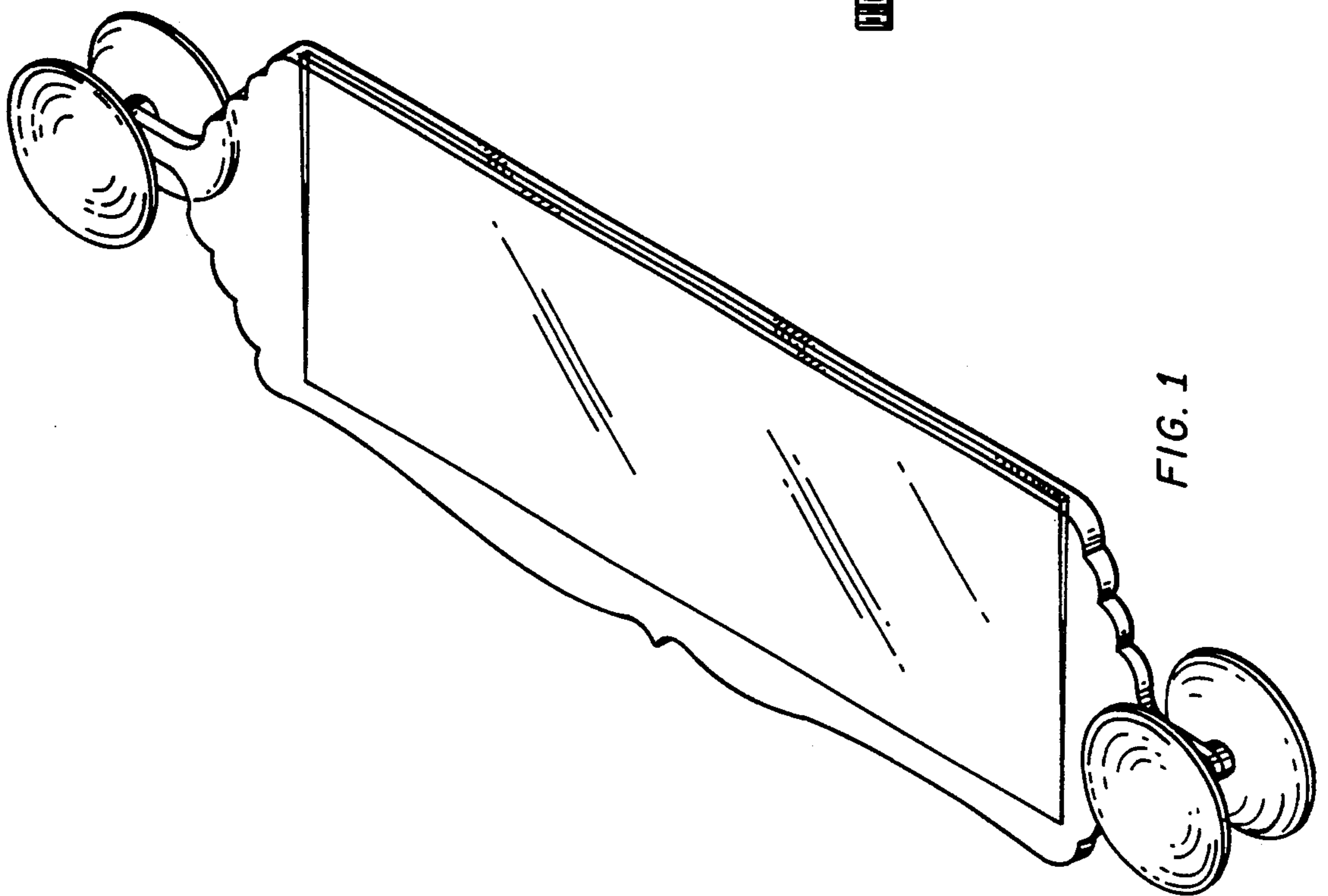

FIG. 1

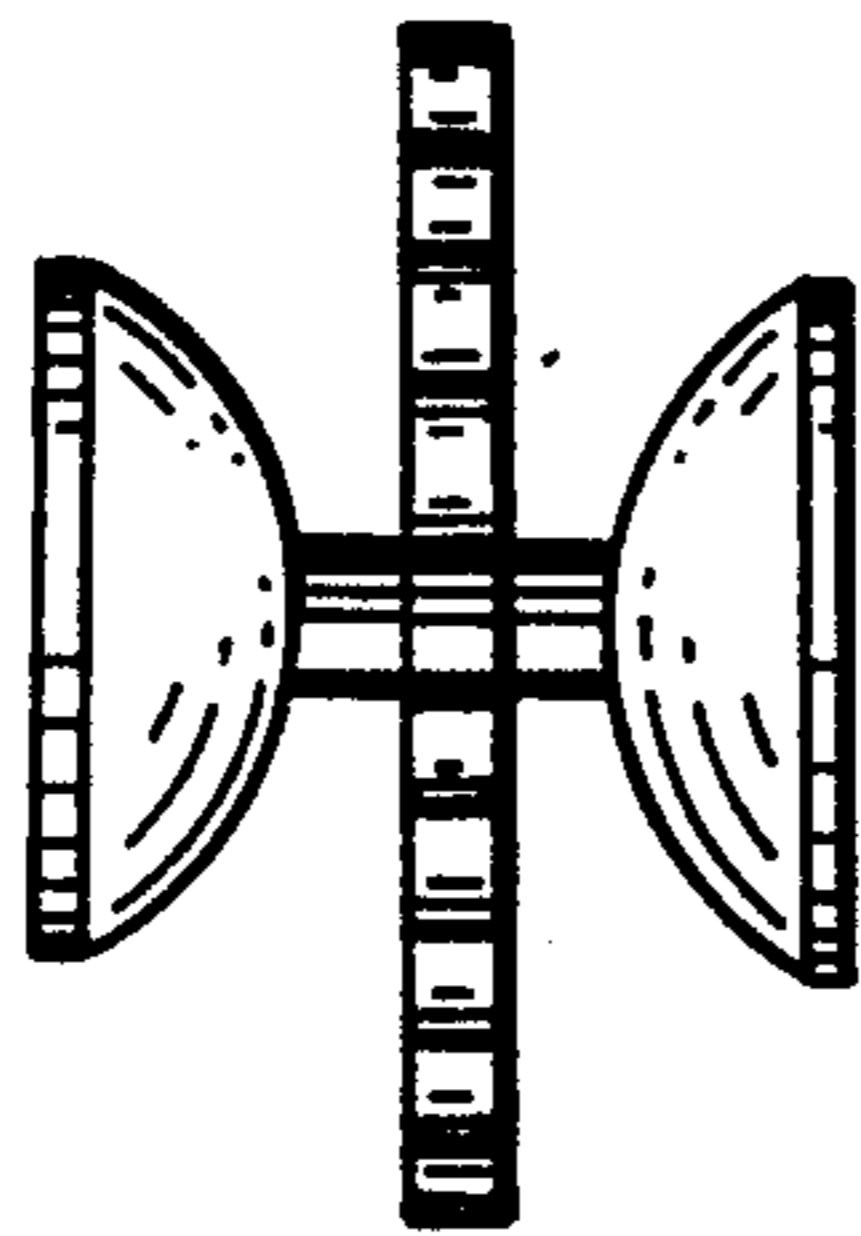

FIG. 2

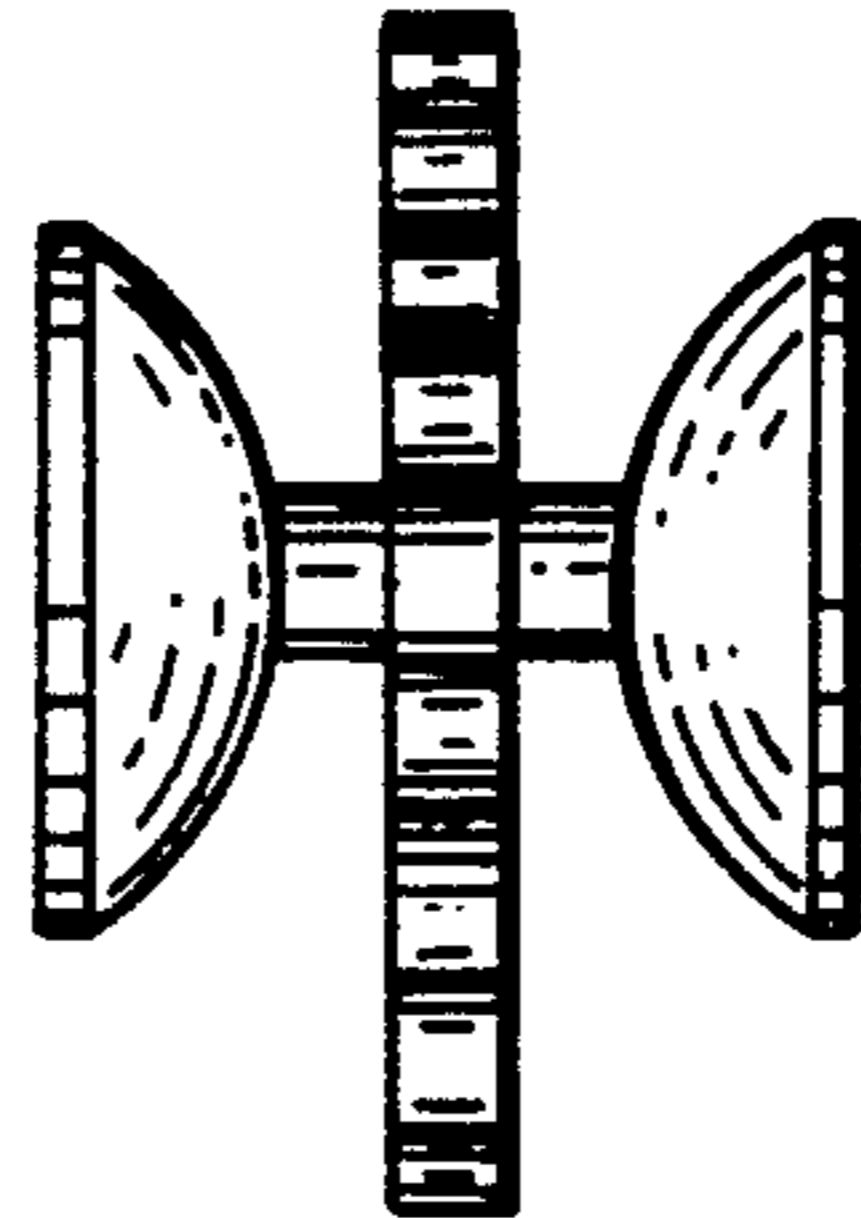

FIG. 3

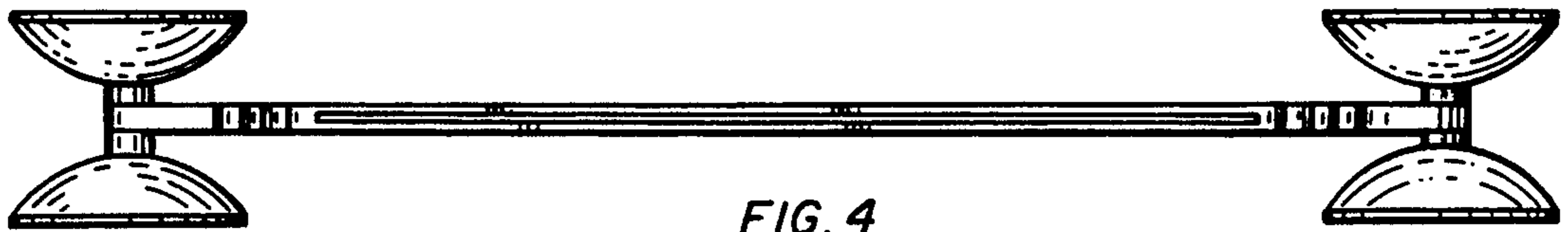

FIG. 4

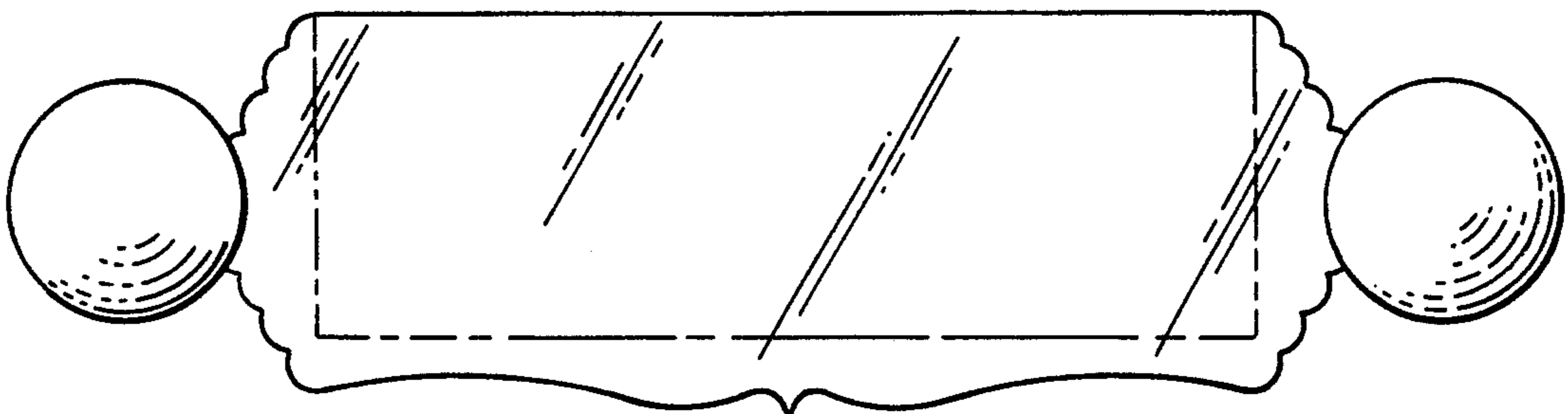

FIG. 5

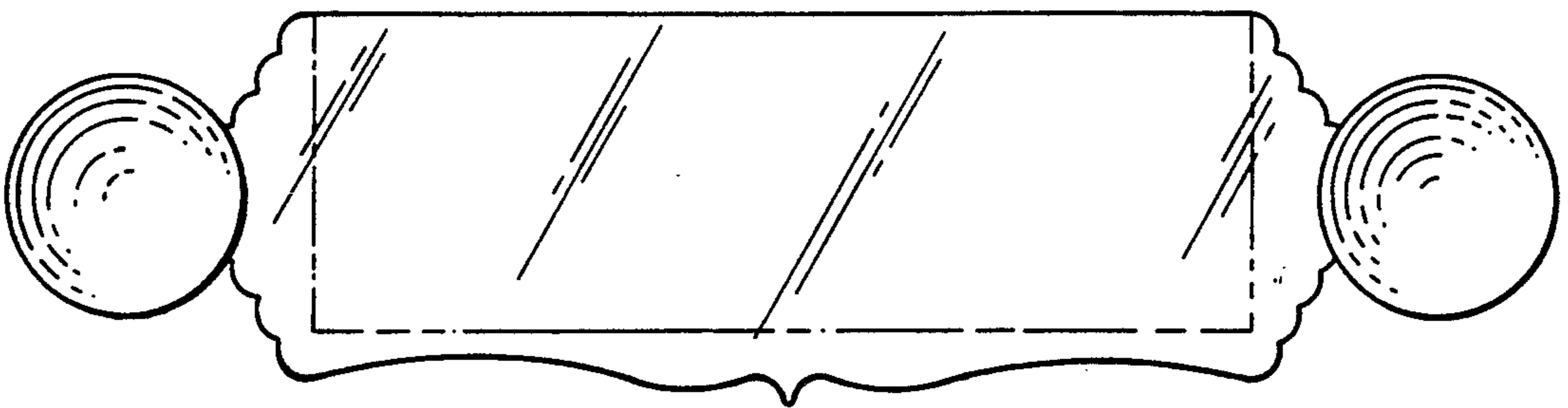

FIG. 6

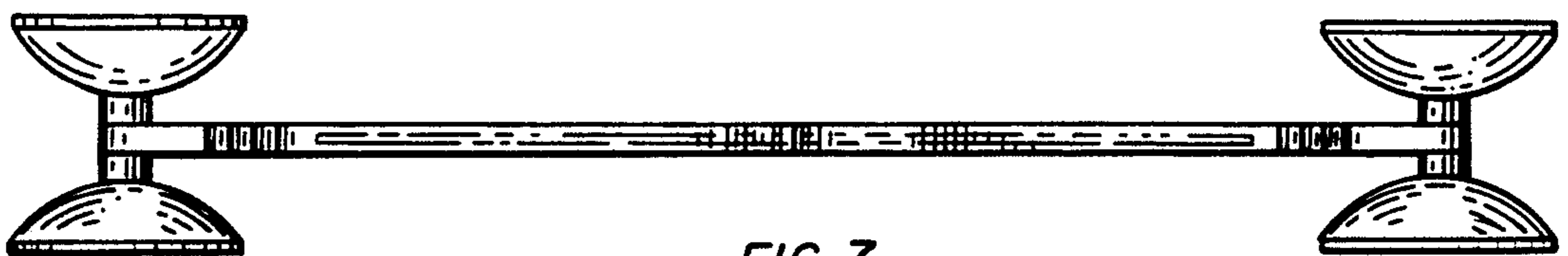

FIG. 7

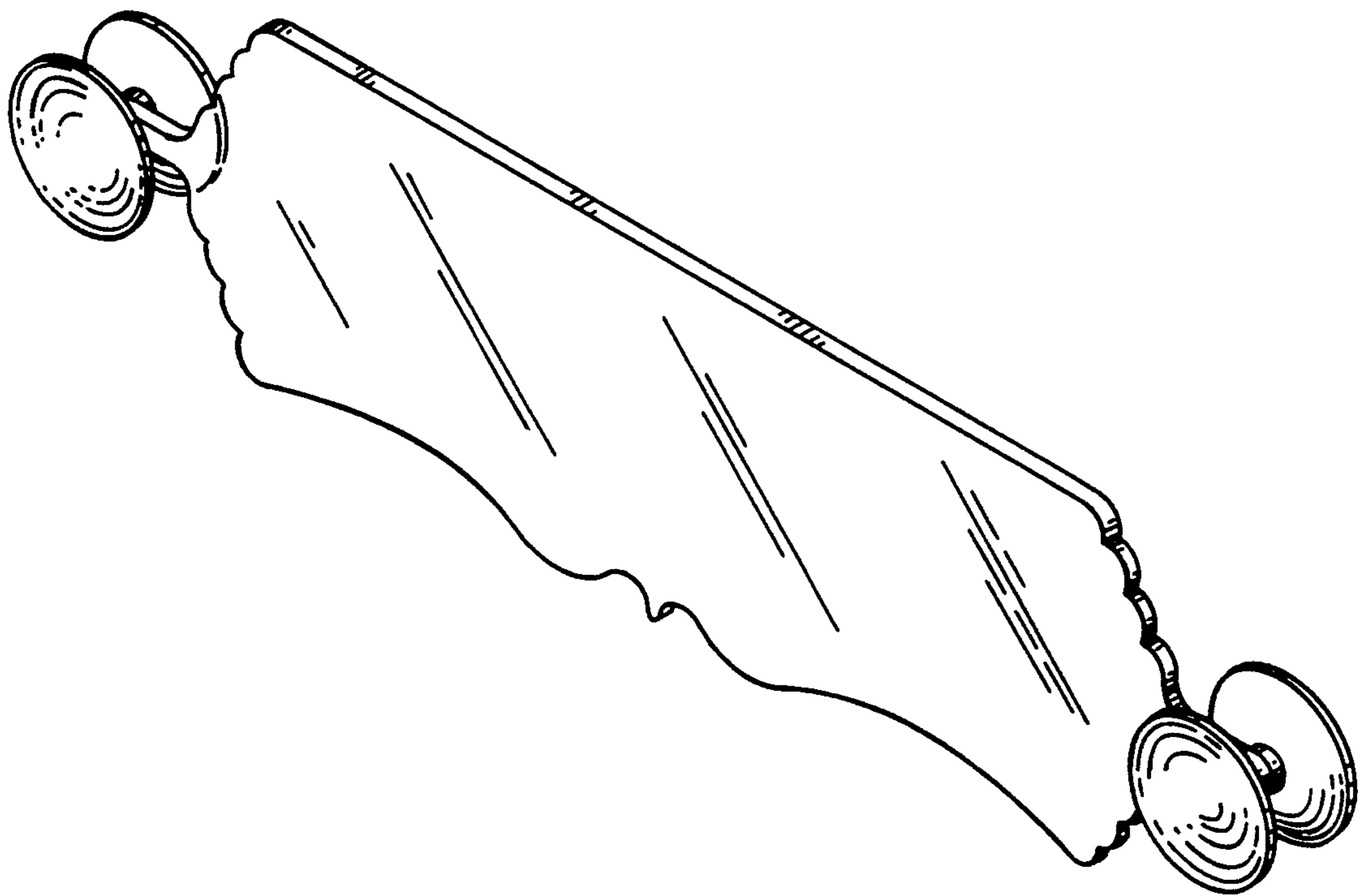

FIG. 8