

[54] REMOTE RADIOTELEPHONE HEADSET

[76] Inventor: Patrick G. Phelan, 2044 Shore Road, R.R. 3, Eastern Passage, Nova Scotia, Canada, B3G-1H5

[**] Term: 14 Years

[21] Appl. No.: 538,477

[22] Filed: Jun. 15, 1990

[52] U.S. Cl. D14/223; D14/205; D14/253

[58] Field of Search D14/147, 138, 205, 144, D14/206, 150; 379/455, 89, 430, 61, 62; D21/211; 455/90

[56] References Cited

U.S. PATENT DOCUMENTS

- D. 292,400 10/1987 Boggs et al. D14/147
- D. 305,759 1/1990 Balbuena D14/147
- 4,175,217 11/1979 Williams 379/430

- 4,654,883 3/1987 Iwata 455/90 X
- 4,882,745 11/1989 Silver 455/90 X
- 4,930,148 5/1990 Lee 379/430 X

Primary Examiner—Horace B. Fay, Jr.
Attorney, Agent, or Firm—Leon Gilden

[57] CLAIM

The ornamental design for a remote radiotelephone headset, as shown and described.

DESCRIPTION

FIG. 1 is a front elevational view of a remote radiotelephone headset showing my new design;
 FIG. 2 is a rear elevational view thereof;
 FIGS. 3 and 4 are respectively left and right elevational views thereof;
 FIGS. 5 and 6 are respectively top and bottom plan views thereof;
 FIG. 7 is a top perspective view thereof; and
 FIG. 8 and 9 are respectively top and bottom perspective views thereof.

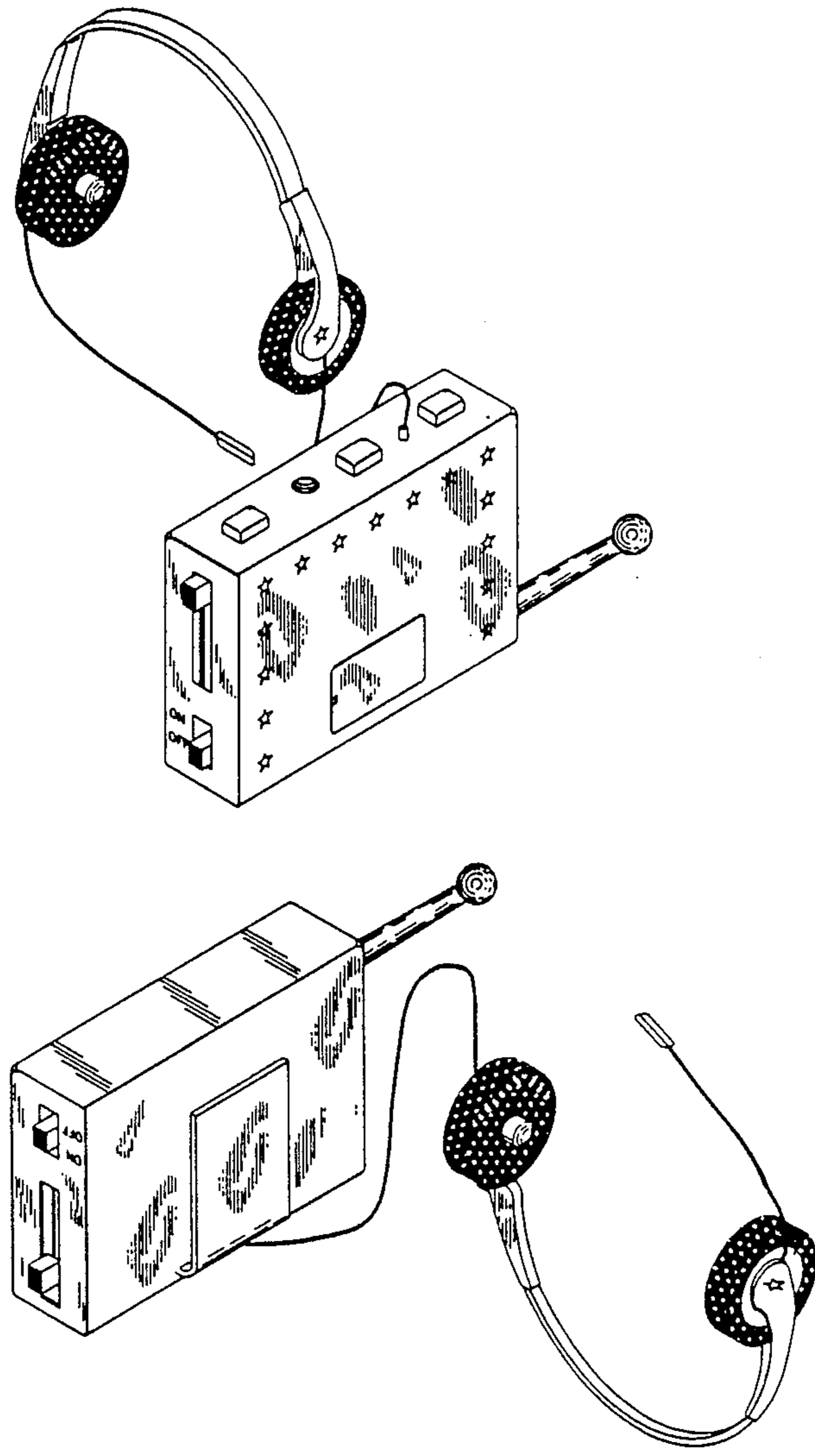

FIG. 1

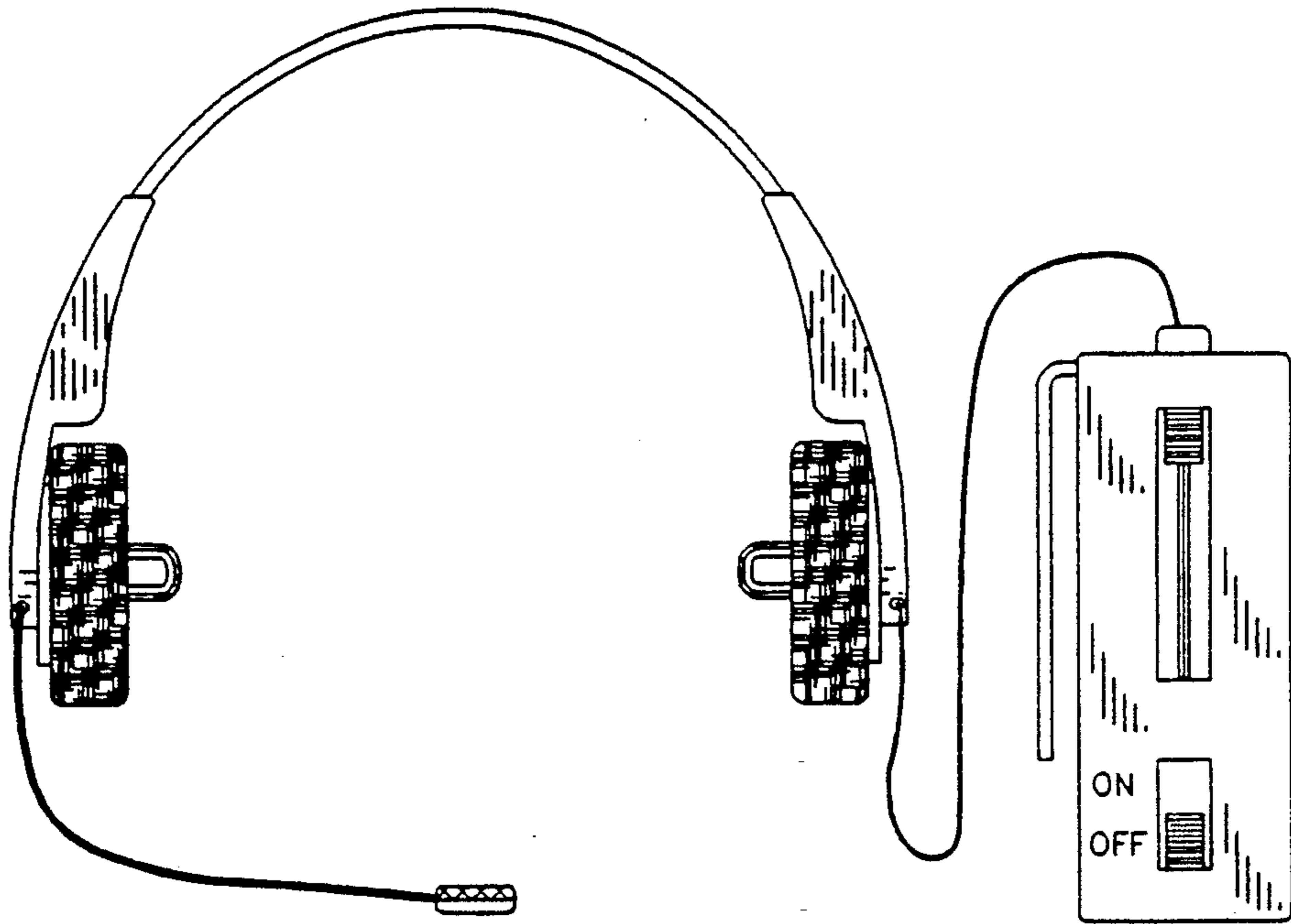

FIG. 2

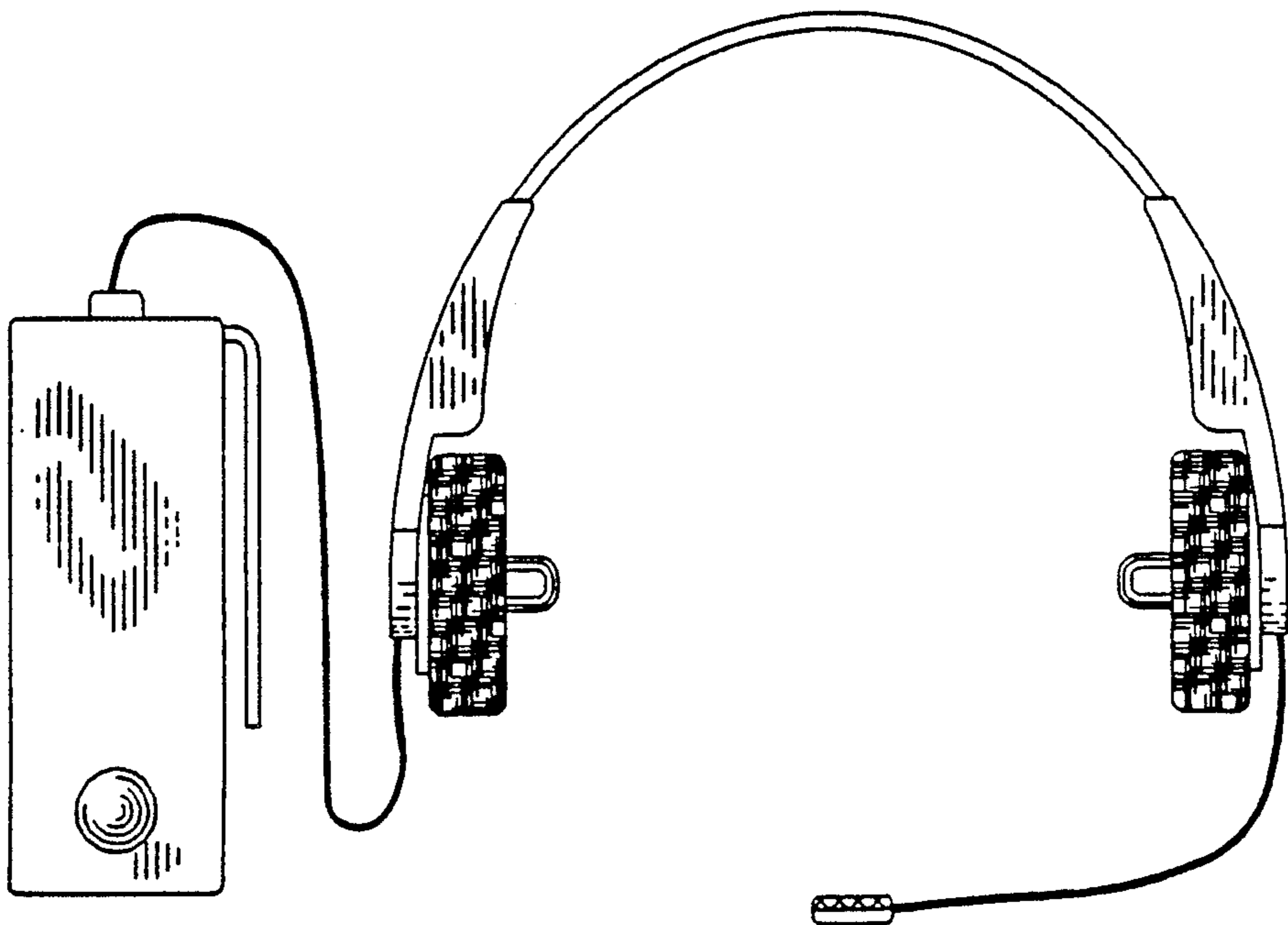

FIG. 3

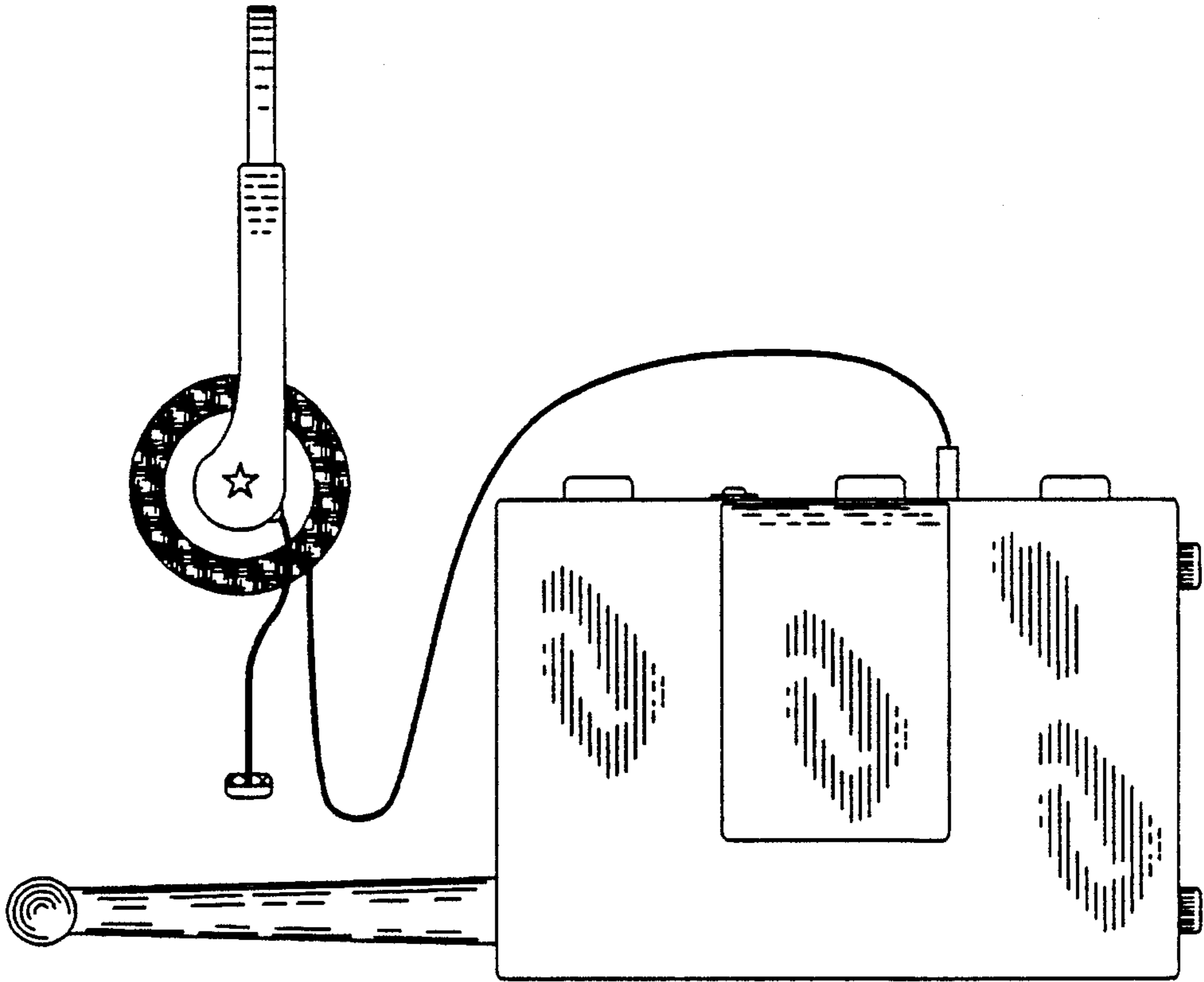

FIG. 4

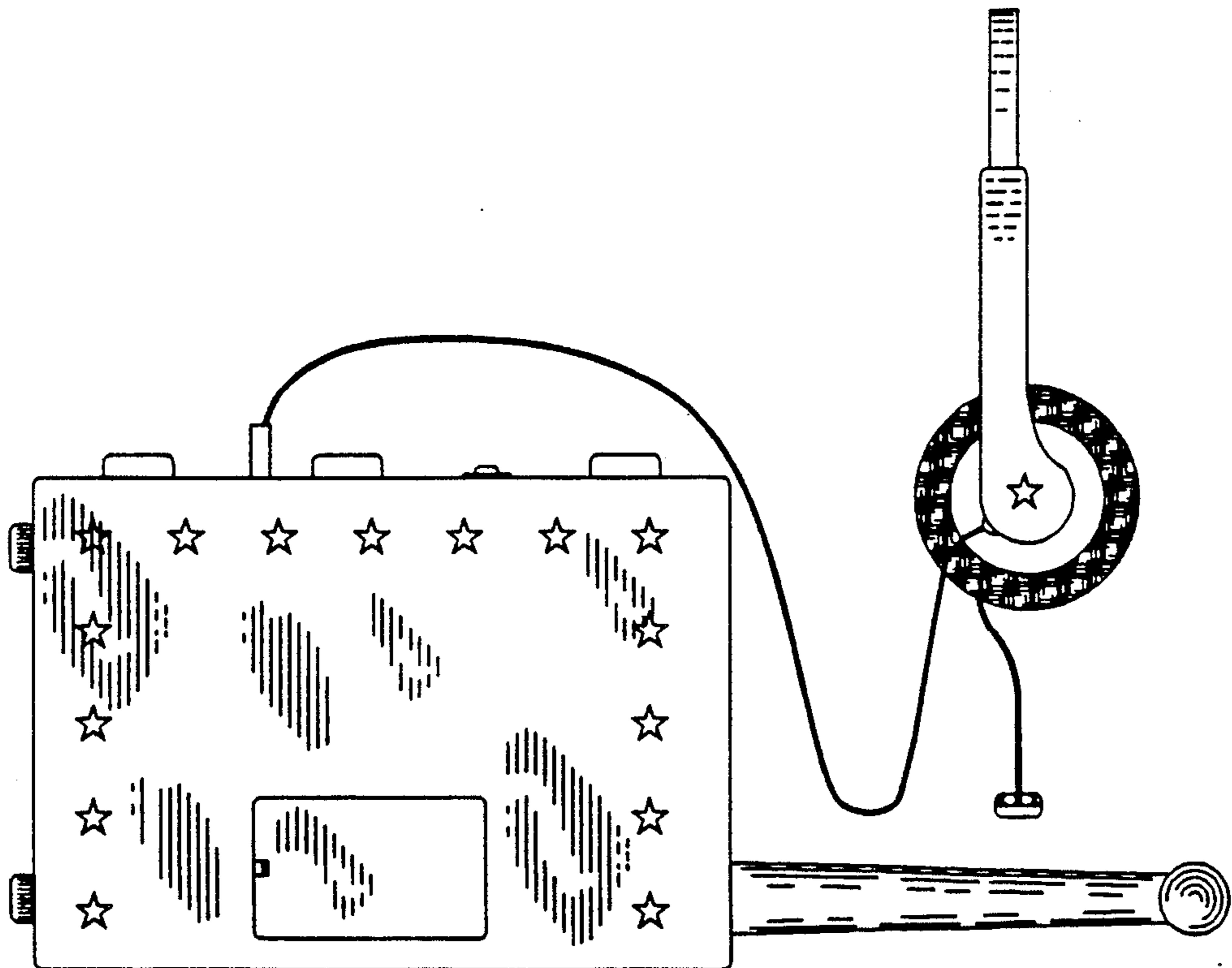

FIG. 5

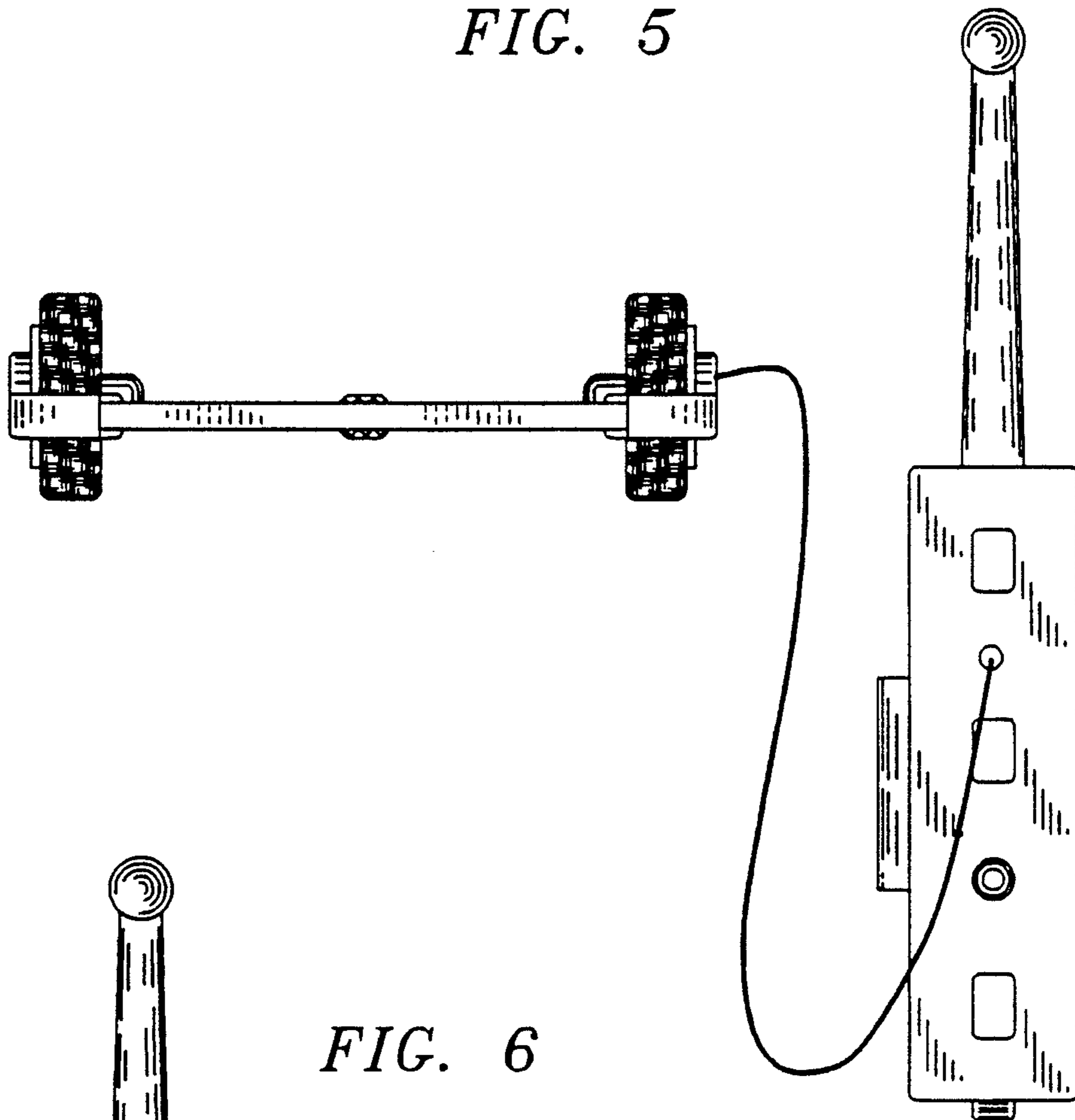

FIG. 6

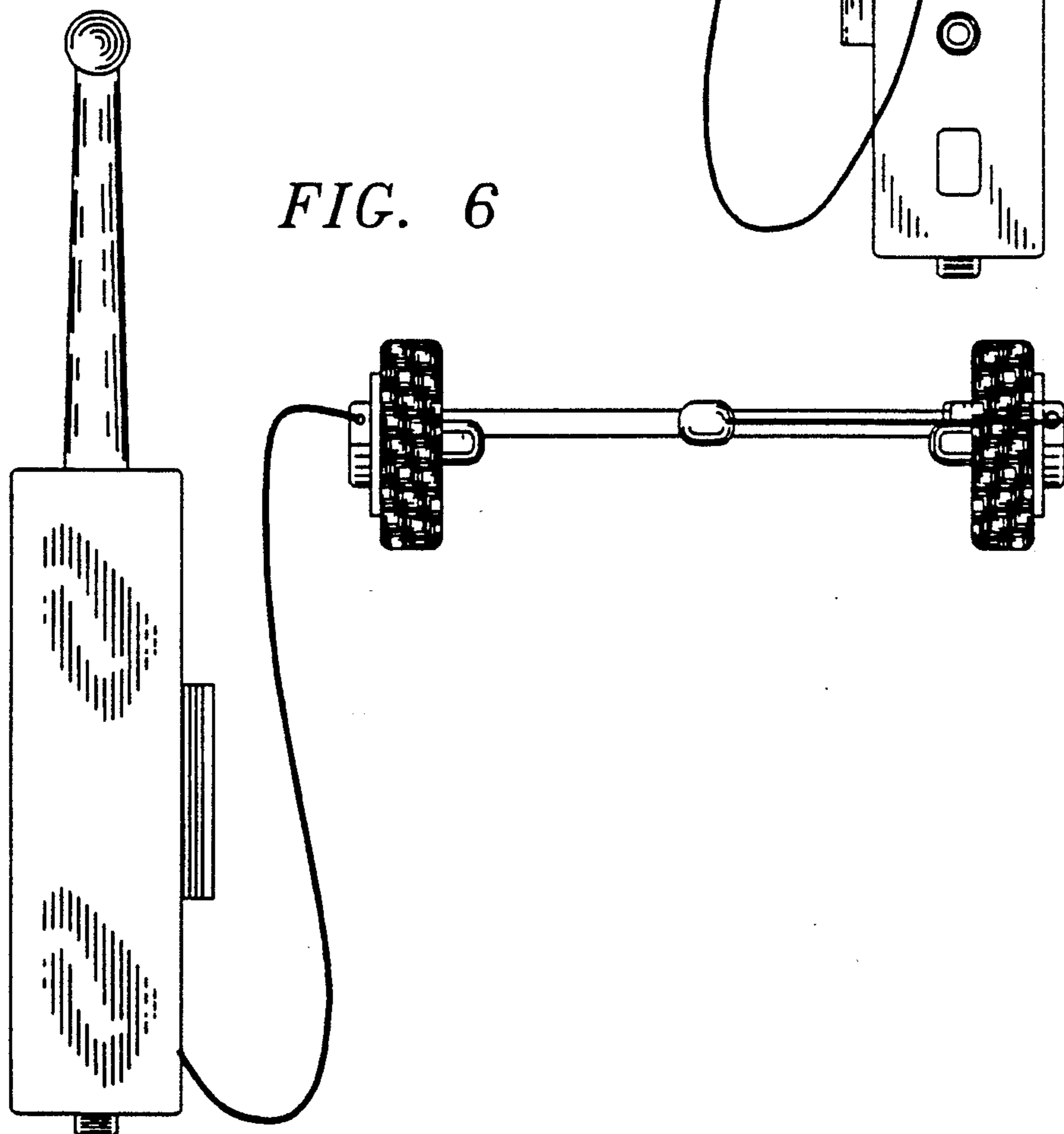

FIG. 7

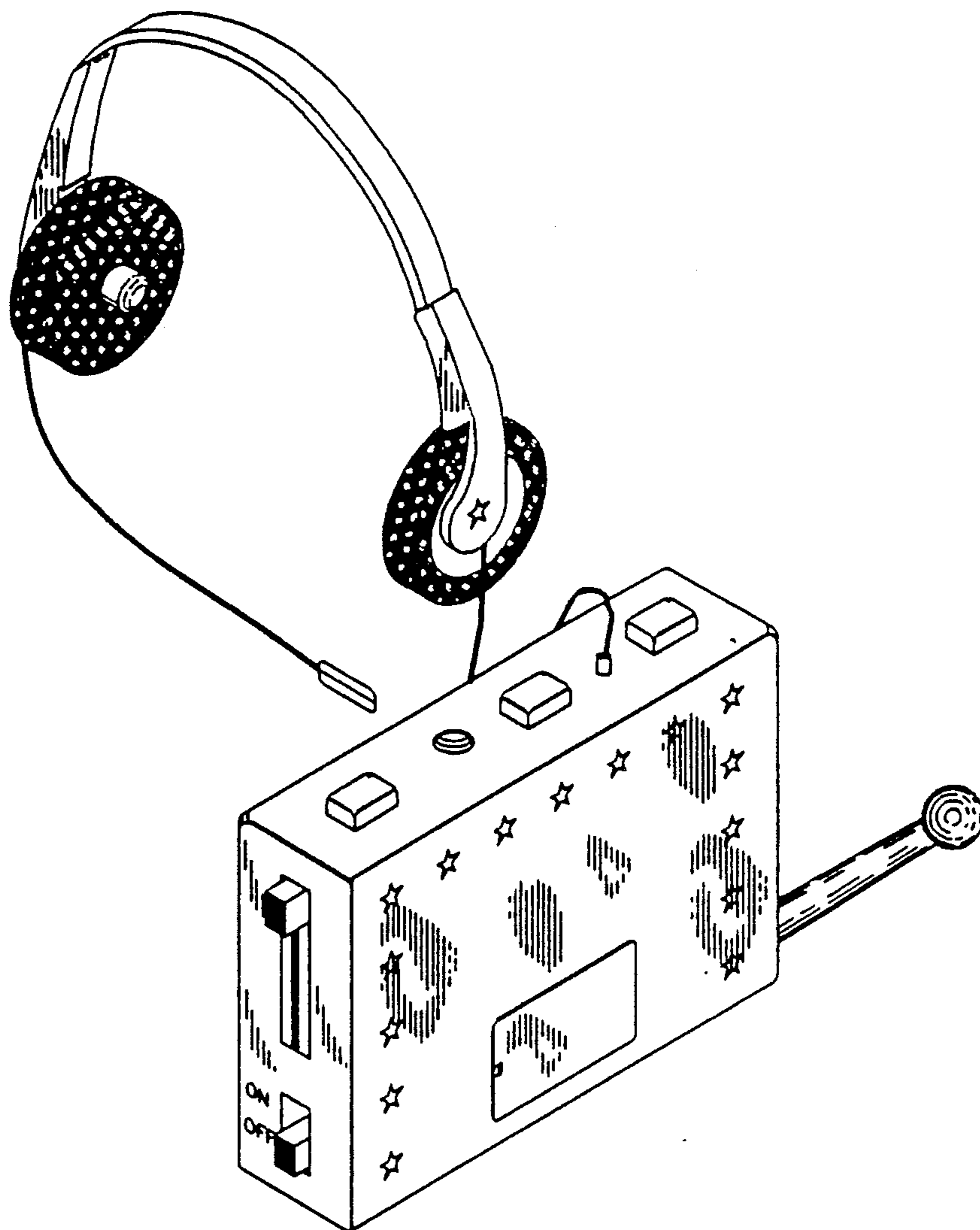

FIG. 8

