

[54] **FLOWER POT COVER**

[75] **Inventors:** Donald E. Weder; Erwin Weder, deceased, both of Highland, Ill., by Donald E. Weder and Wanda M. Weder, co-executors; Wanda M. Weder, Highland, Calif.; Franklin J. Craig, Valley Park, Mo.; Wilma M. Donnelly, Highland, Ill.; Phyllis J. Bolk, Highland, Ill.; John W. Bergstrand, Highland, Ill.; Robert C. Abrams, Edwardsville, Ill.

[73] **Assignee:** Highland Supply Corporation, Highland, Ill.

[**] **Term:** 14 Years

[21] **Appl. No.:** 108,351

[22] **Filed:** Oct. 13, 1987

D. 292,563	11/1987	Weder et al.	D11/164
D. 293,222	12/1987	Weder et al.	D11/164
D. 293,223	12/1987	Weder et al.	D11/164
D. 293,304	12/1987	Weder et al.	D11/164
D. 293,305	12/1987	Weder et al.	D11/164
D. 293,306	12/1987	Weder et al.	D11/164
D. 293,307	12/1987	Weder et al.	D11/164
D. 293,308	12/1987	Weder et al.	D11/164
D. 293,774	1/1988	Weder et al.	D11/164
D. 293,775	1/1988	Weder et al.	D11/164
D. 296,535	7/1988	Weder et al.	D11/149
D. 297,422	8/1988	Weder et al.	D11/164
D. 298,017	10/1988	Weder et al.	D11/164
D. 301,565	6/1989	Weder	D11/152
D. 302,139	7/1989	Weder	D11/153
D. 302,253	7/1989	Weder	D11/153
D. 302,254	7/1989	Weder	D11/153
D. 302,404	7/1989	Weder	D11/153
D. 302,405	7/1989	Weder	D11/155
D. 302,406	7/1989	Weder	D11/155
D. 302,407	7/1989	Weder	D11/155
D. 303,775	10/1989	Weder	D11/155

Related U.S. Application Data

[63] Continuation-in-part of Ser. No. 613,053, May 22, 1984, Pat. No. Des. 293,224.

[52] **U.S. Cl.** D11/164; D11/143

[58] **Field of Search** D11/143, 152, 153, 155, D11/156, 164; 47/66, 72; 206/423; 215/100.5; 229/4.5, 922; 248/27.8; 428/35.1, 542.6

References Cited

U.S. PATENT DOCUMENTS

209,788	11/1878	Affel .	
D. 254,659	4/1980	Karotseris	D11/143
D. 287,950	1/1987	Weder et al.	D11/143
D. 289,024	3/1987	Vaughn	D11/164
D. 289,982	5/1987	Weder et al.	D11/164
D. 292,182	10/1987	Weder et al.	D11/164
D. 292,183	10/1987	Weder et al.	D11/164
D. 292,184	10/1987	Weder et al.	D11/164
D. 292,185	10/1987	Weder et al.	D11/164
D. 292,186	10/1987	Weder et al.	D11/164
D. 292,187	10/1987	Weder et al.	D11/164
D. 292,188	10/1987	Weder et al.	D11/164
D. 292,189	10/1987	Weder et al.	D11/164
D. 292,190	10/1987	Weder et al.	D11/164
D. 292,191	10/1987	Weder et al.	D11/164
D. 292,561	11/1987	Weder et al.	D11/164
D. 292,562	11/1987	Weder et al.	D11/164

1,069,675	8/1913	Claussen .	
1,446,563	2/1923	Hughes .	
1,520,647	12/1924	Hennegan .	
1,868,853	7/1932	Sievers .	
1,924,926	8/1933	Gray	65/53
2,302,259	11/1942	Rothfuss	41/10
2,355,559	8/1944	Renner	229/8
2,482,981	9/1949	Kamrass	41/13
2,967,652	1/1961	Canfield et al.	229/5.5
3,022,605	2/1962	Reynolds	47/58
3,271,922	9/1966	Wallerstein et al. .	
3,488,022	1/1970	Vittoria .	
3,542,616	11/1970	Cain et al.	156/224
3,962,503	6/1976	Crawford	428/40
4,043,077	8/1977	Stonehocker	47/66
4,118,890	10/1978	Shore	47/28 R
4,170,618	10/1979	Adams	264/101
4,216,620	8/1980	Weder et al.	47/72
4,300,312	11/1981	Weder et al.	D11/143
4,413,725	11/1983	Bruno et al.	206/45.33
4,508,223	4/1985	Catrambone	206/423
4,733,521	3/1988	Weder et al.	53/580
4,773,182	9/1988	Weder et al.	47/72
4,795,601	1/1989	Cheng	264/138
4,835,834	6/1989	Weder	29/525

FOREIGN PATENT DOCUMENTS

560532 4/1975 Switzerland .

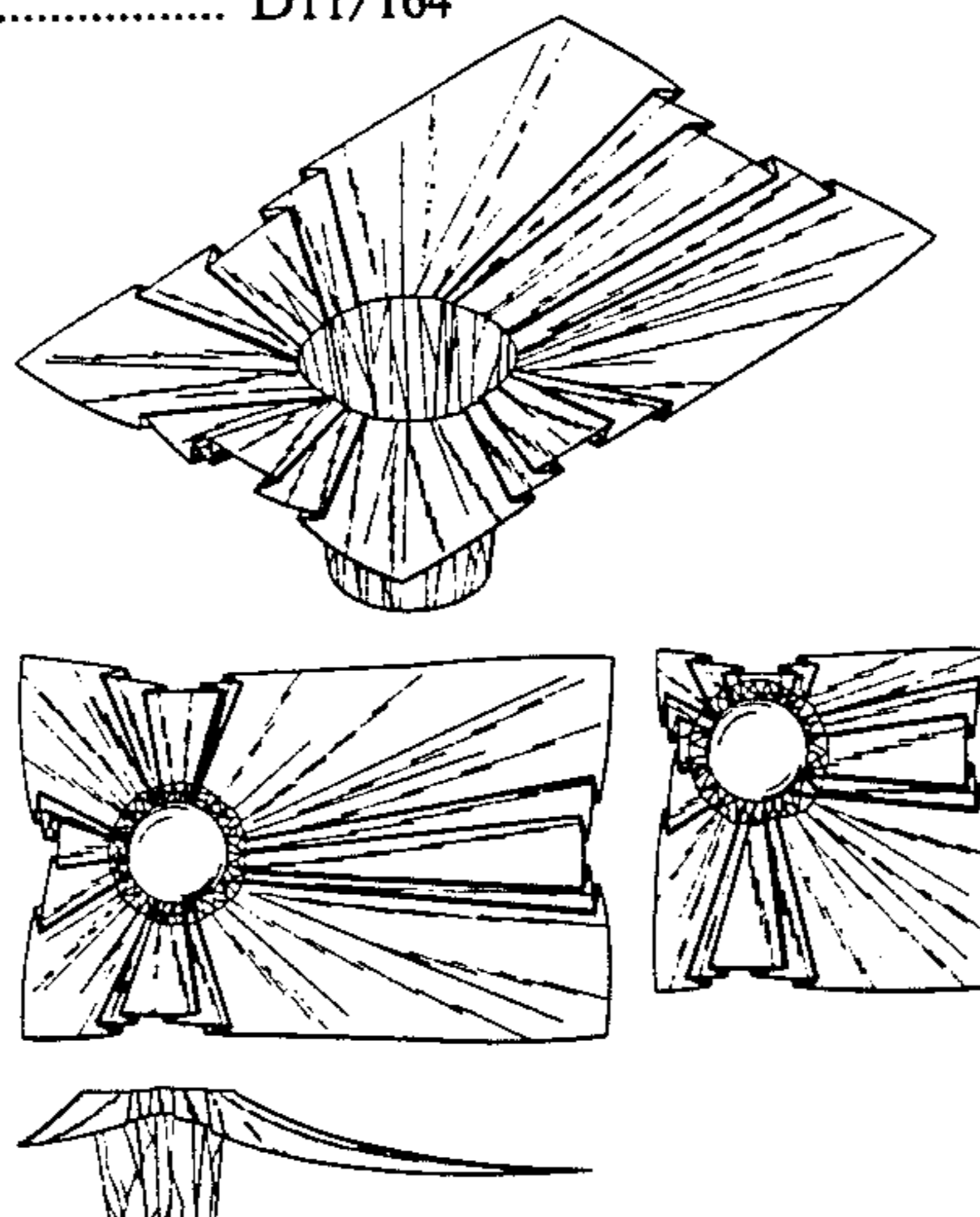

OTHER PUBLICATIONS

Exhibit A. Curtis Wagner Co., Inc., Houston, Tex, shows thick, stiff, shiny red plastic pot cover with large scalloped border. (Photograph) Date unknown.

Exhibit B. Date of first use unknown, Jacobson Pot Cover Co., Scranton, Pa., advertising literature.

Exhibit C. Photograph of pot cover, manufacturer unknown, date unknown.

Exhibit D. Photocopy of photo of pot cover ("Platform Pot Dresser") made by John Raisen Corp., San Francisco, Calif., date of first use unknown.

Exhibit E. Photograph of 2-part pot cover system made by Floral Decor, subsidiary of John Henry Co., Lansing, Mich., date unknown.

Exhibit F. Photo of pot cover made by a Holland Company ("K.P.I."), date of first public use believed to be late 1984.

Exhibit G. "The Glass of Frederick Carder", copyright 1971 by P. V. Gardner, showing various styles of glass basket-like vases or containers.

Exhibit H. "Speed Cover" brochure, published 1983 by Applicants, showing various pot covers.

Exhibit I. "Speed Cover" brochure, published 1983 by Applicants, showing various pot covers.

Exhibit J. Item published in 1936 by Gellman Bros., Minneapolis, Minn., shows an assortment of paper hats.

Exhibit K. Photo of various other flower pot wrapping, sold in rolls or sheets and used in the floral industry many years.

Exhibit L. Photo of pot cover made of woven straw--like material, date unknown.

Exhibit M. Photo of basket-type pot cover used in the floral industry, date unknown.

Exhibit N. "Speed Cover" brochure, published 1984 by Applicants, showing various pot covers.

Primary Examiner—B. J. Bullock

Attorney, Agent, or Firm—Dunlap, Coddling, Peterson & Lee

[57]

CLAIM

The ornamental design for a flower pot cover, as shown and described.

DESCRIPTION

FIG. 1 is a perspective view of a flower pot cover showing our new design;

FIG. 2 is a reduced top plan view thereof;

FIG. 3 is a reduced right side elevational view thereof, the left side being a mirror image;

FIG. 4 is a reduced bottom plan view thereof;

FIG. 5 is a reduced front elevational view thereof;

FIG. 6 is a top plan view of the second embodiment of the design of FIG. 1, the only difference being the size of the skirt on the right;

FIG. 7 is a top plan view of a third embodiment of the design of FIG. 1, the only differences being the size of the skirt and its placement around the body;

FIG. 8 is a top plan view of a fourth embodiment of the design of FIG. 1, the only differences being the size of the skirt and its placement around the body;

FIG. 9 is a right side elevational view of a fifth embodiment of the design of FIG. 1, the only difference being the angle of the skirt;

FIG. 10 is a right side elevational view of a sixth embodiment of the design of FIG. 1, the only difference being the angle of the skirt;

FIG. 11 is a right side elevational view of FIG. 6;

FIG. 12 is a right side elevational view of a seventh embodiment of the design of FIG. 1, the only difference being the size of the skirt on the right and its angle;

FIG. 13 is a right side elevational view of an eighth embodiment of the design of FIG. 1, the only differences being the side of the skirt on the right and its angle;

FIG. 14 is a right side elevational view of FIG. 7;

FIG. 15 is a right side elevational view of a ninth embodiment of the design of FIG. 1, the only differences being the size and angle of the skirt and its placement around the body;

FIG. 16 is a right side elevational view of a tenth embodiment of the design of FIG. 1, the only differences being the size and angle of the skirt and its placement around the body.

The flower pot cover has no substantial thickness.

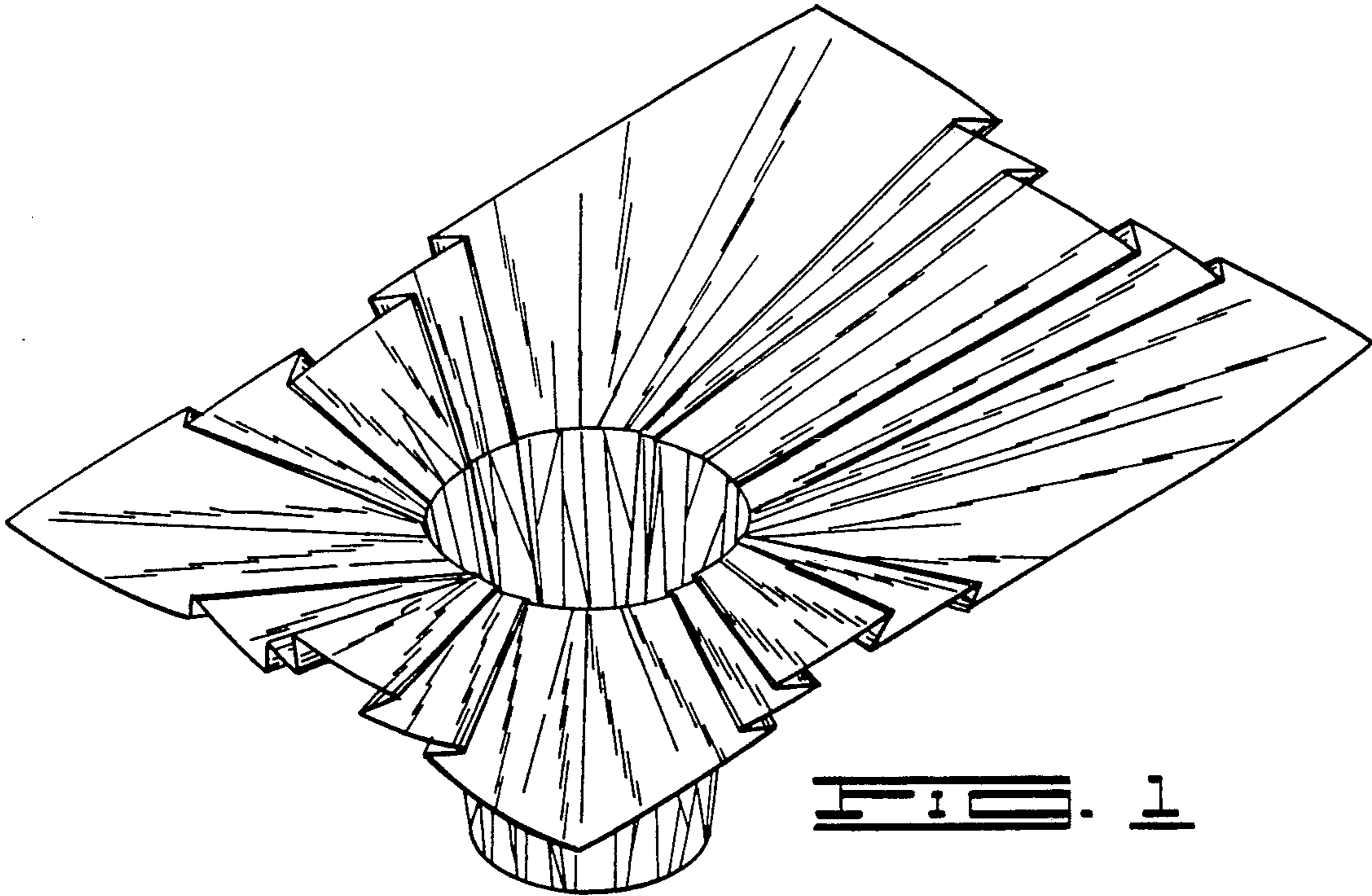

FIG. 1

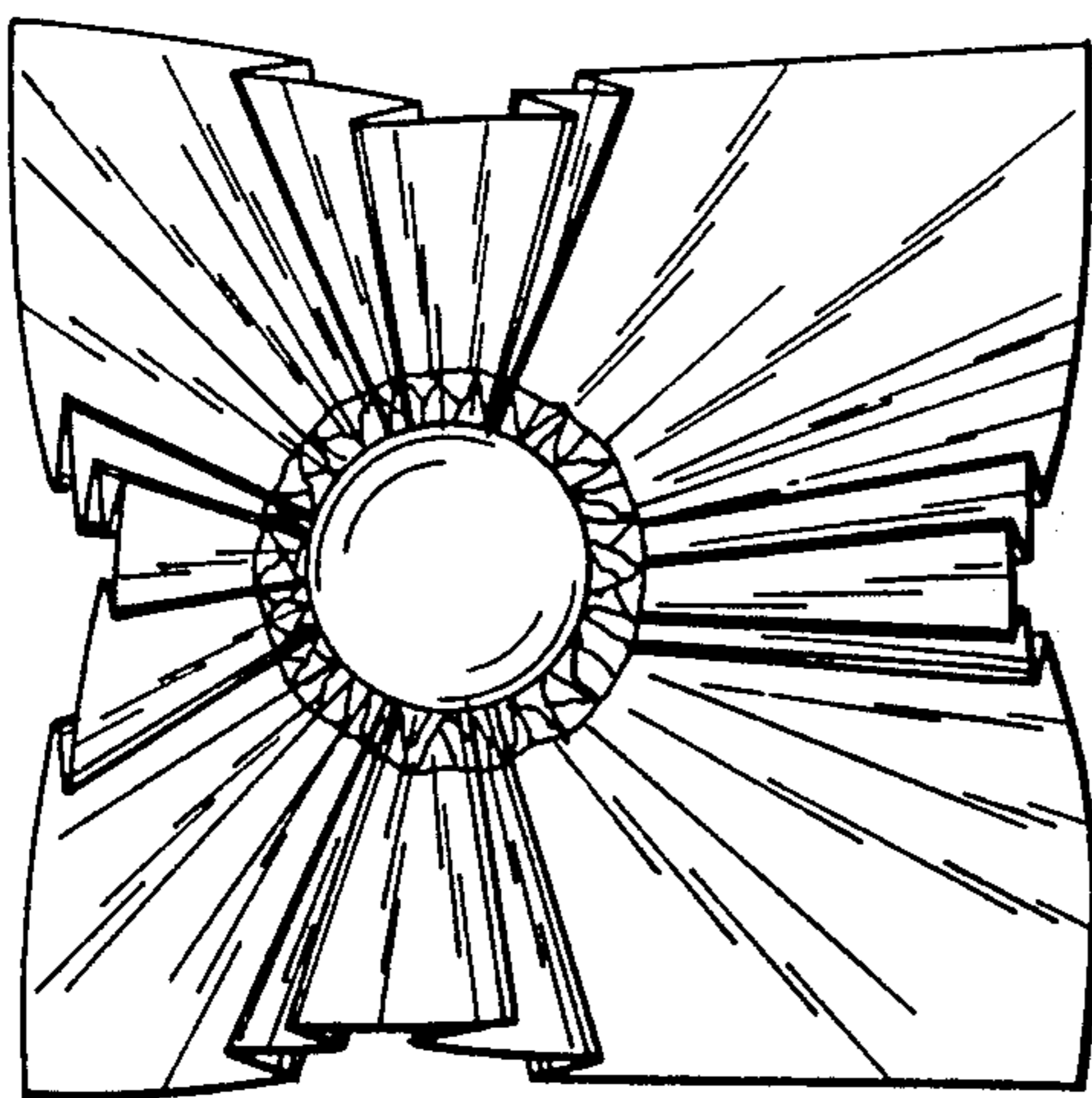

FIG. 2

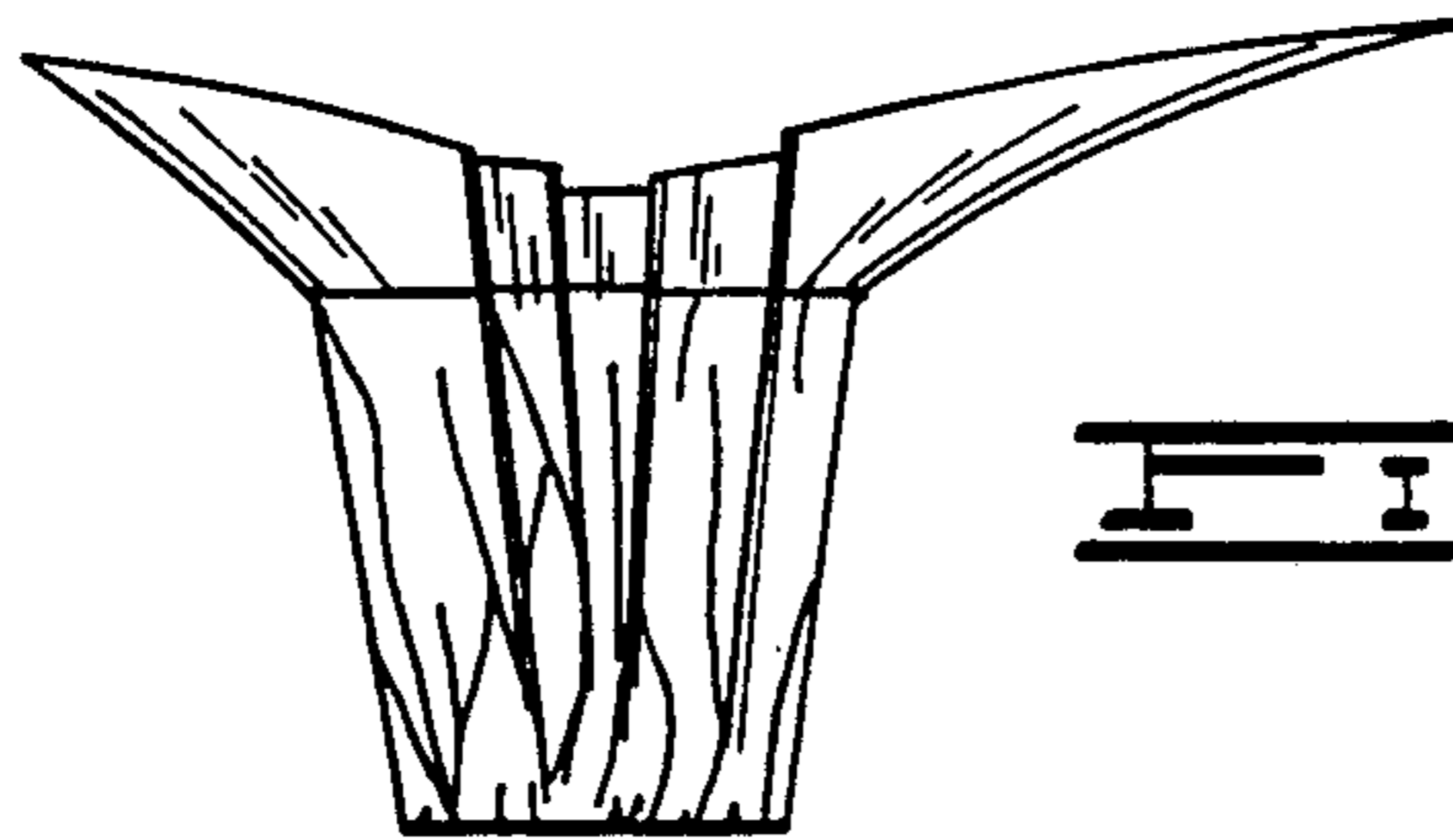

FIG. 3

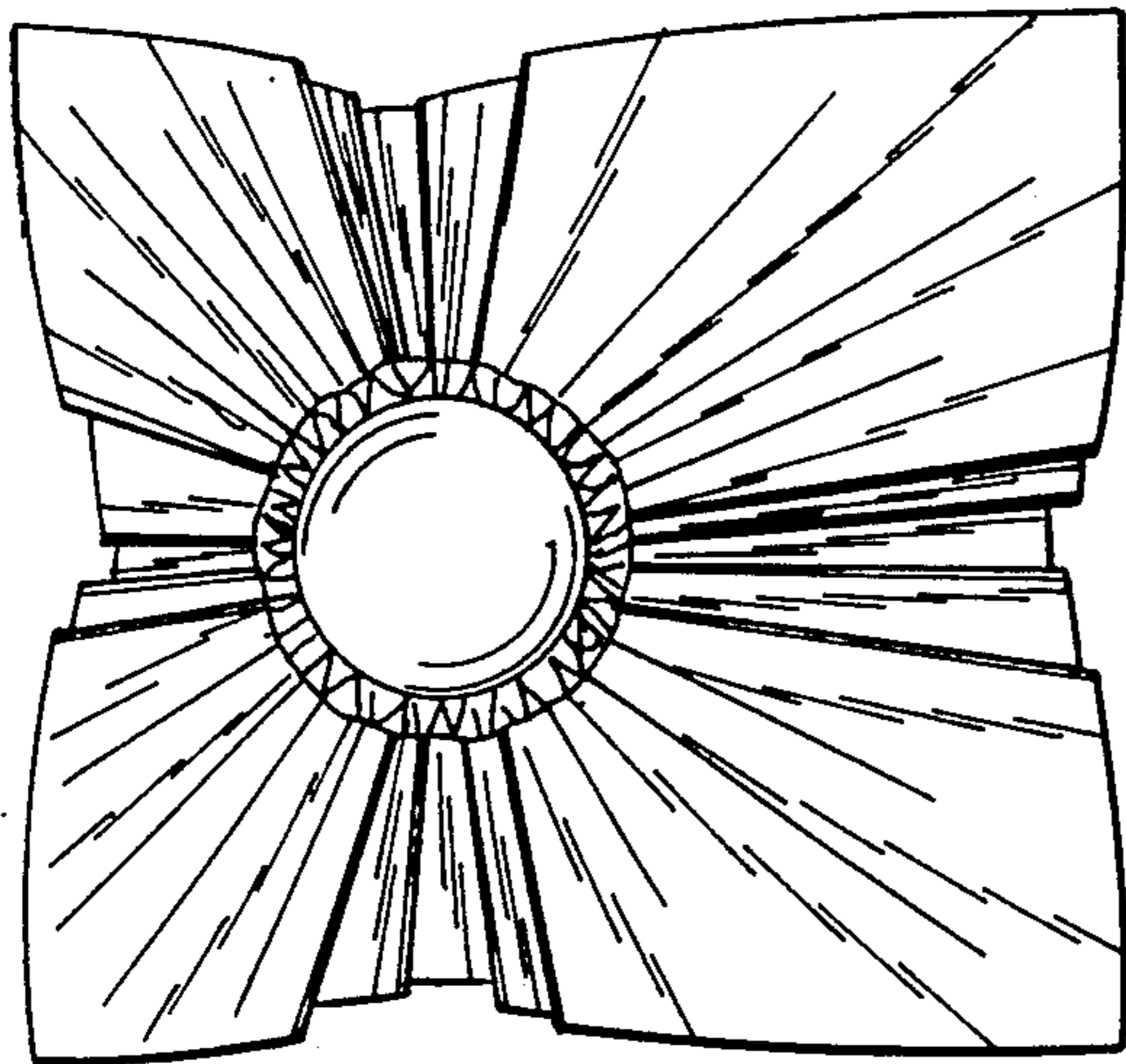

FIG. 4

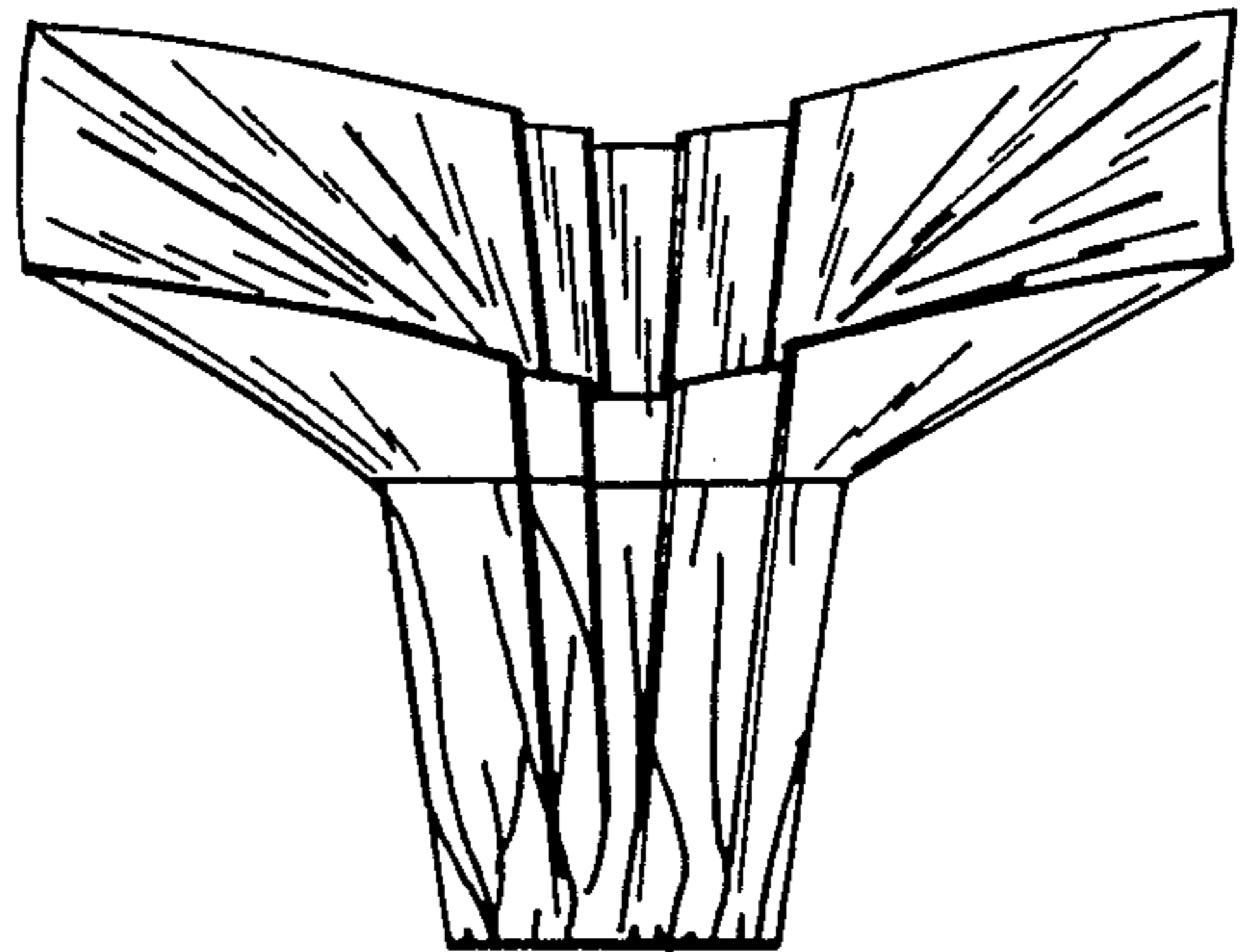

FIG. 5

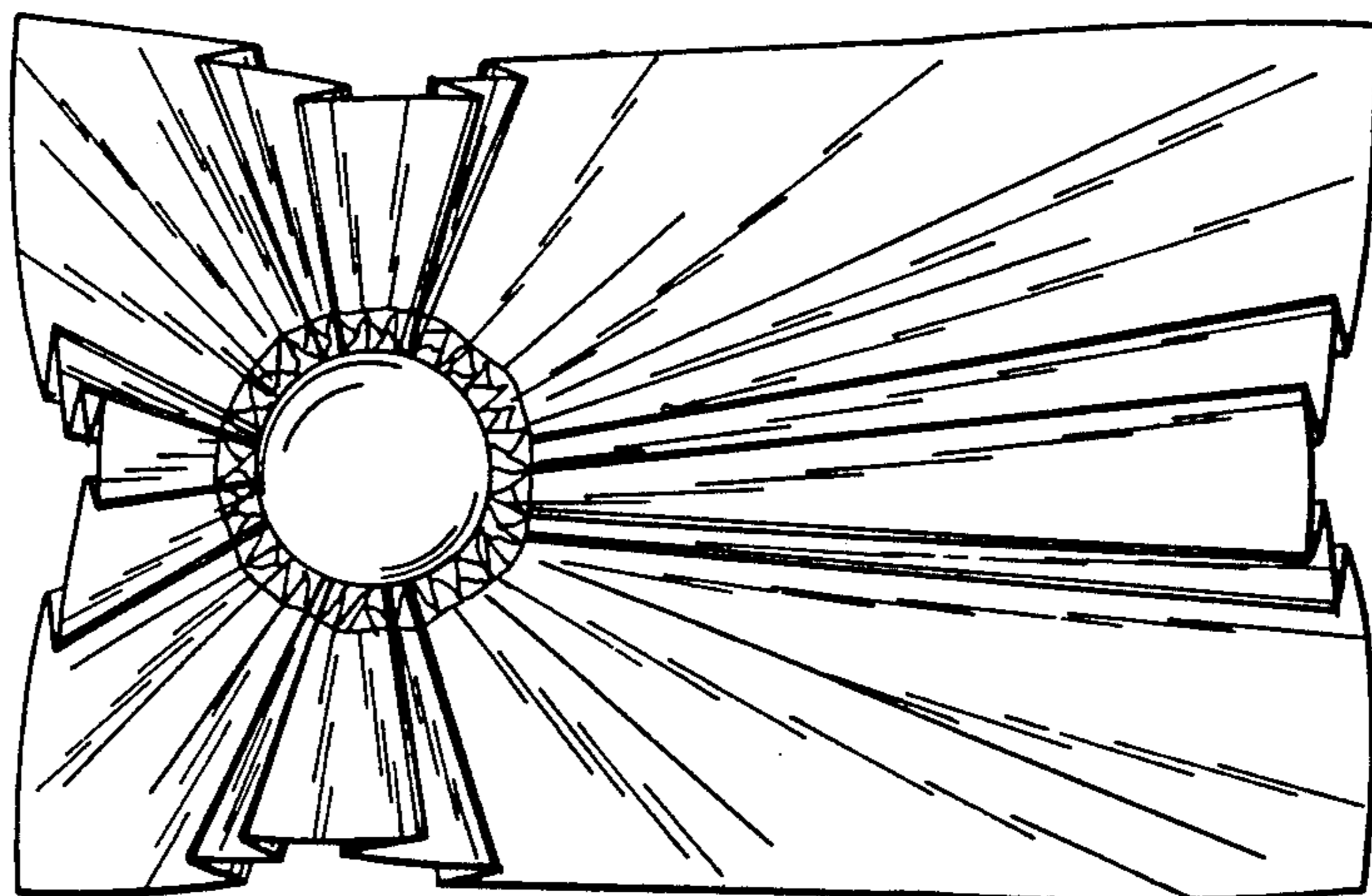

FIG. 6

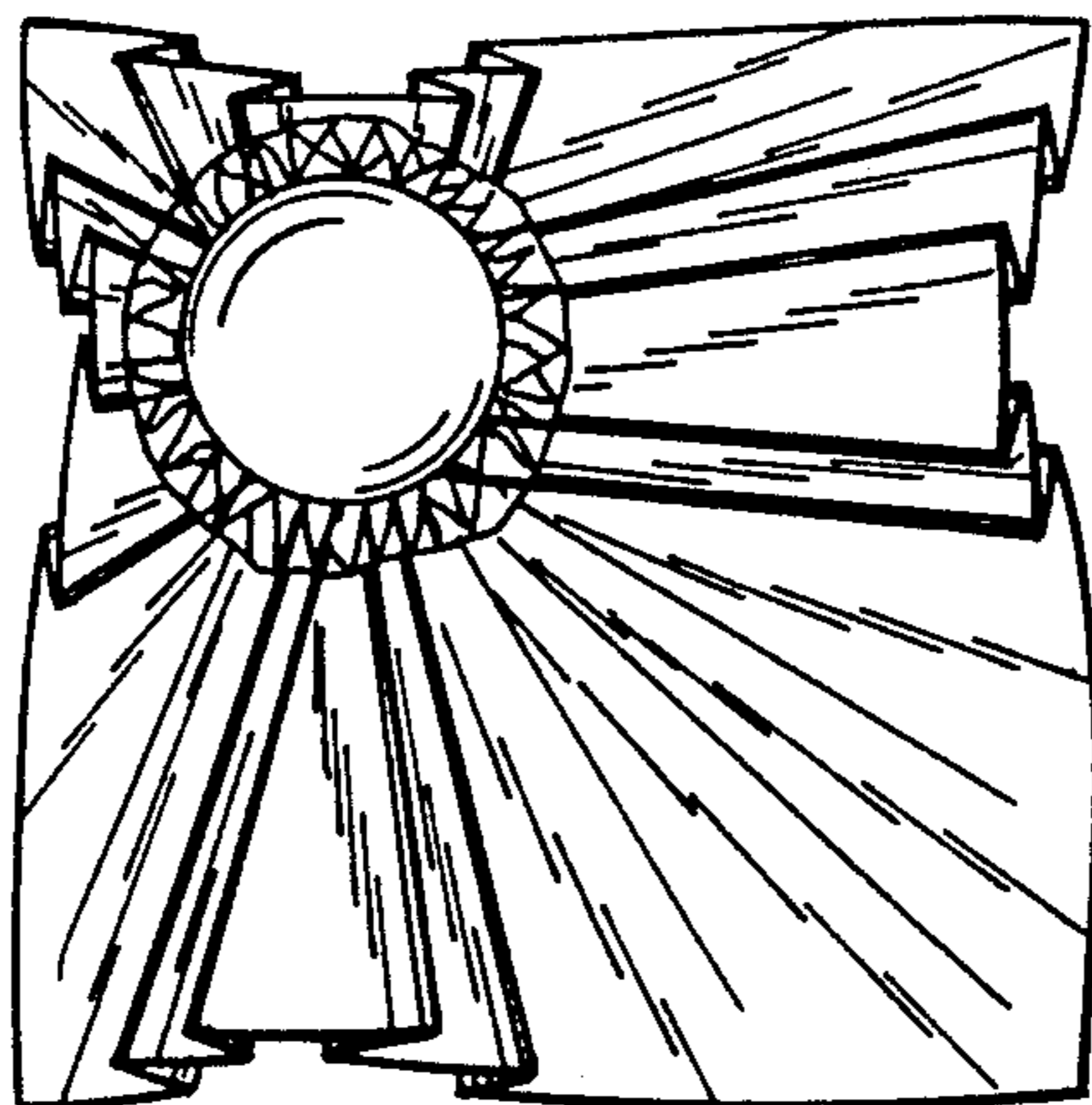

FIG. 7

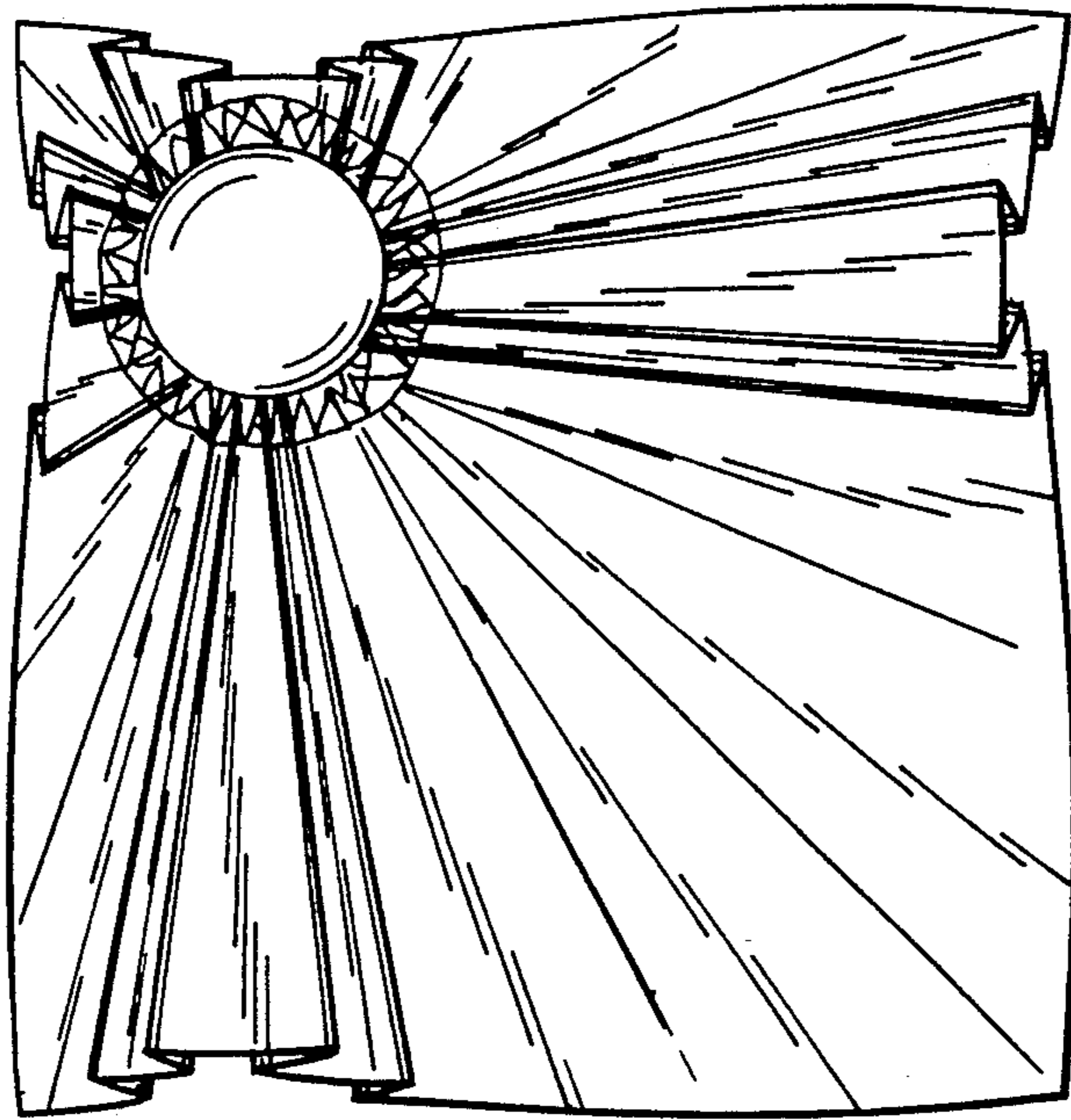

FIG. 8

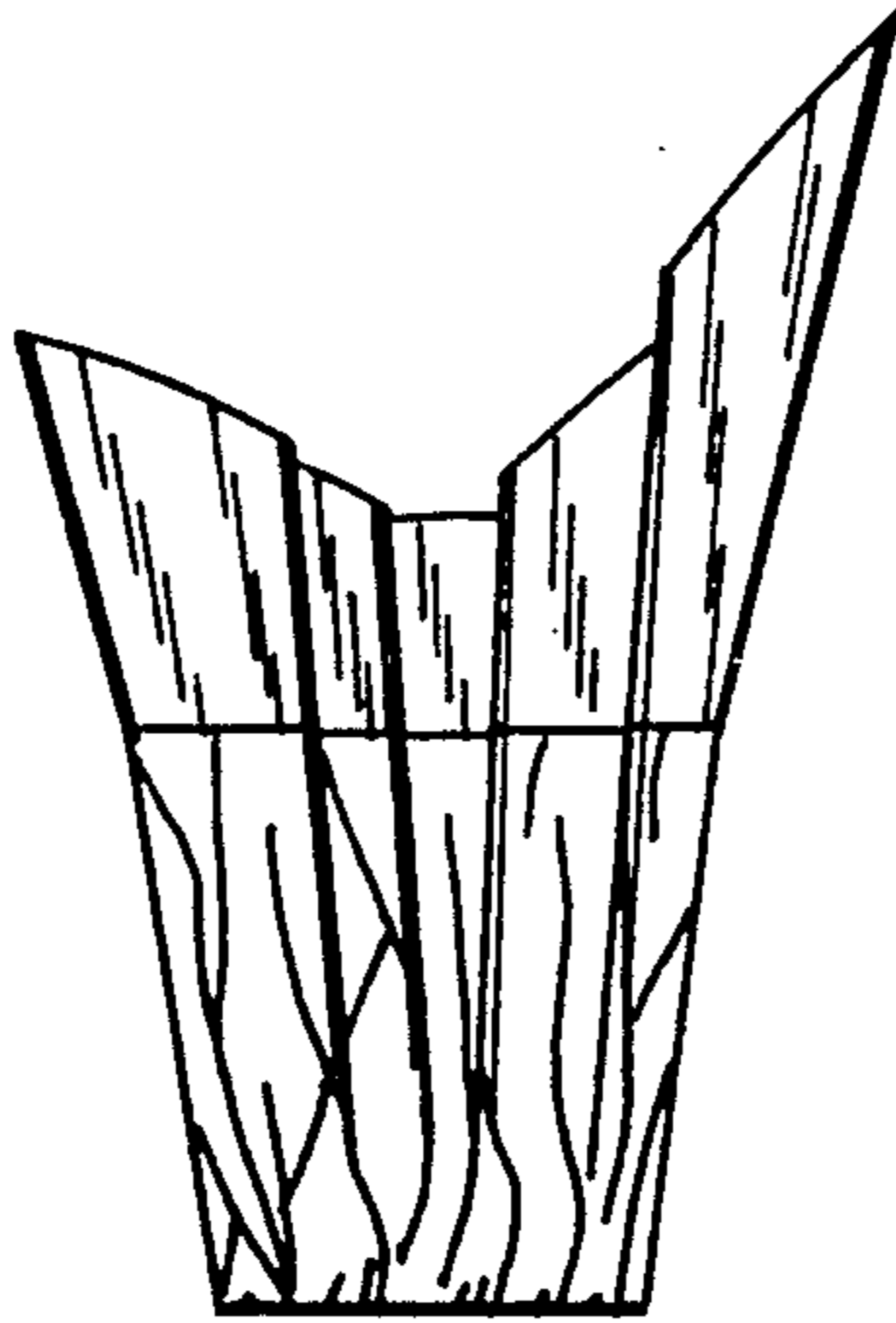

FIG. 9

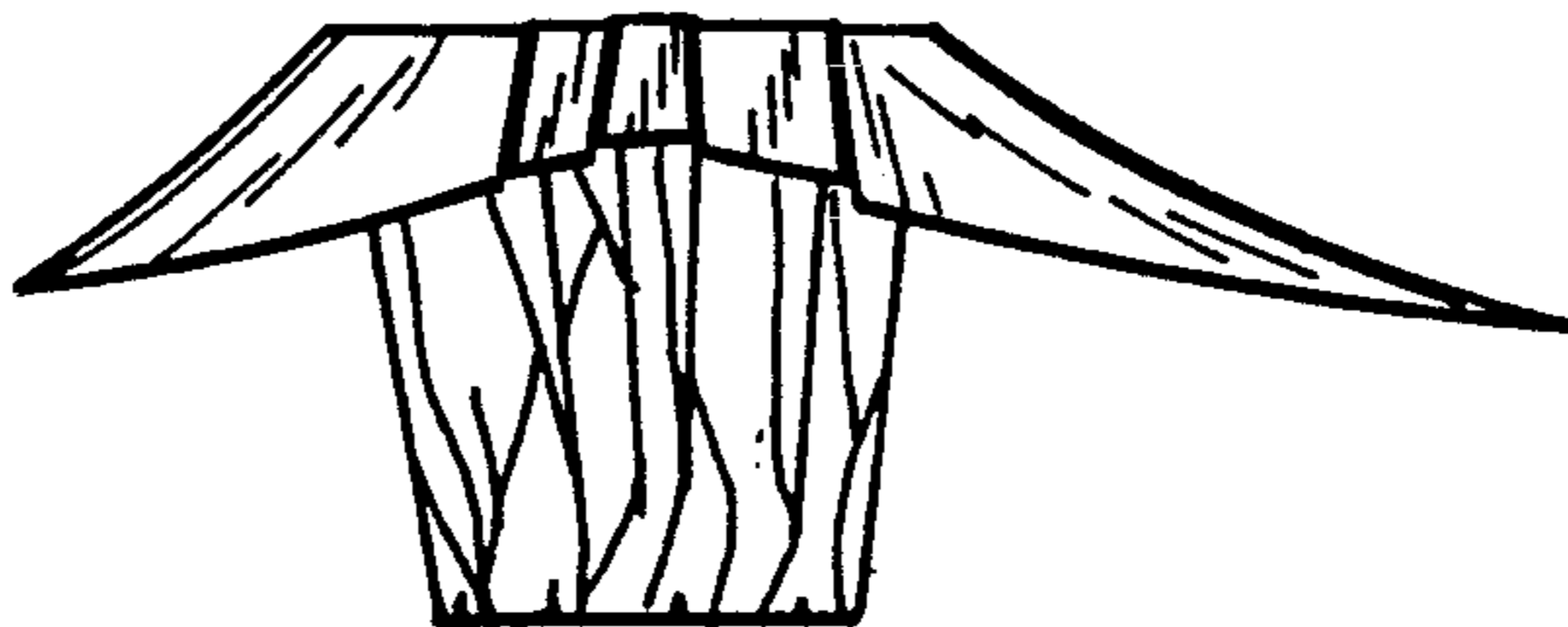

FIG. 10

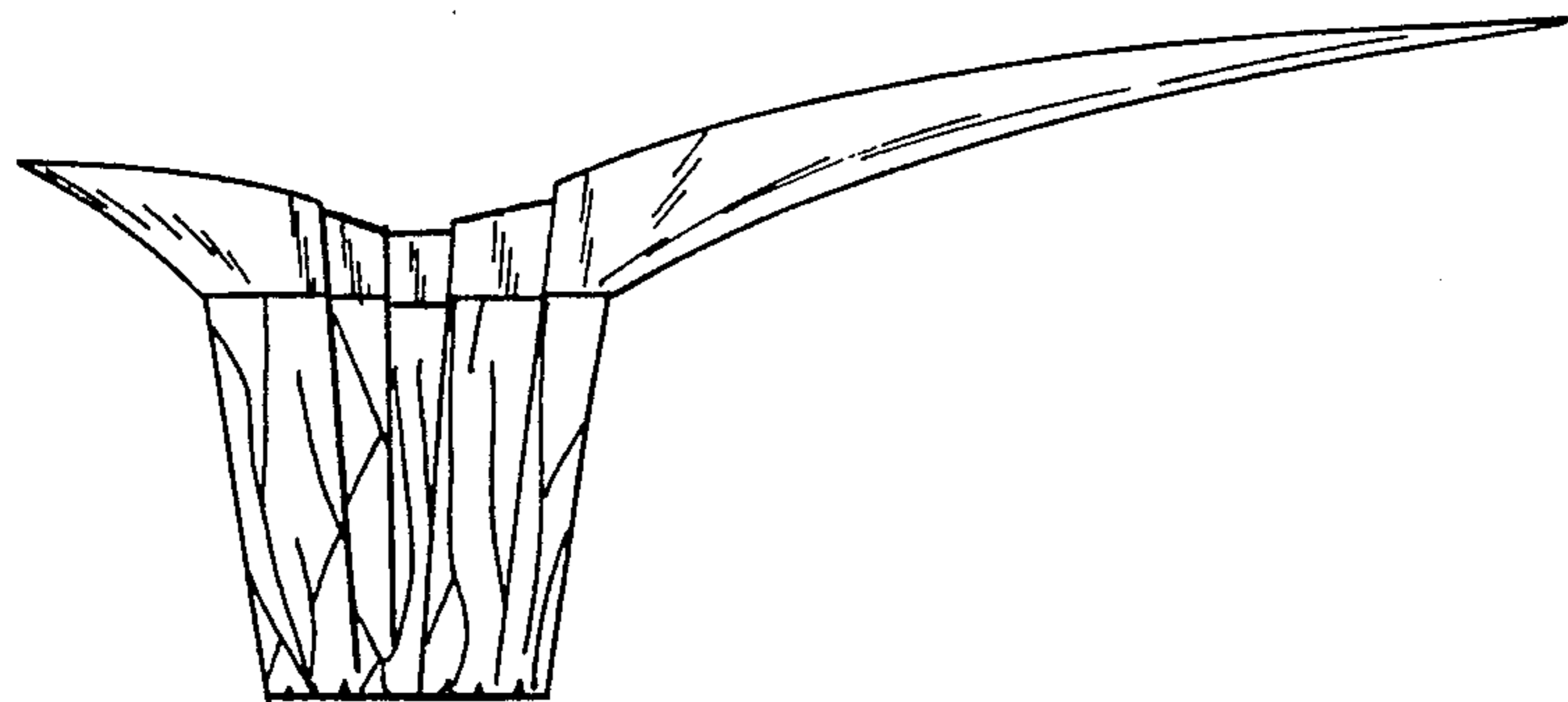

FIG. 11

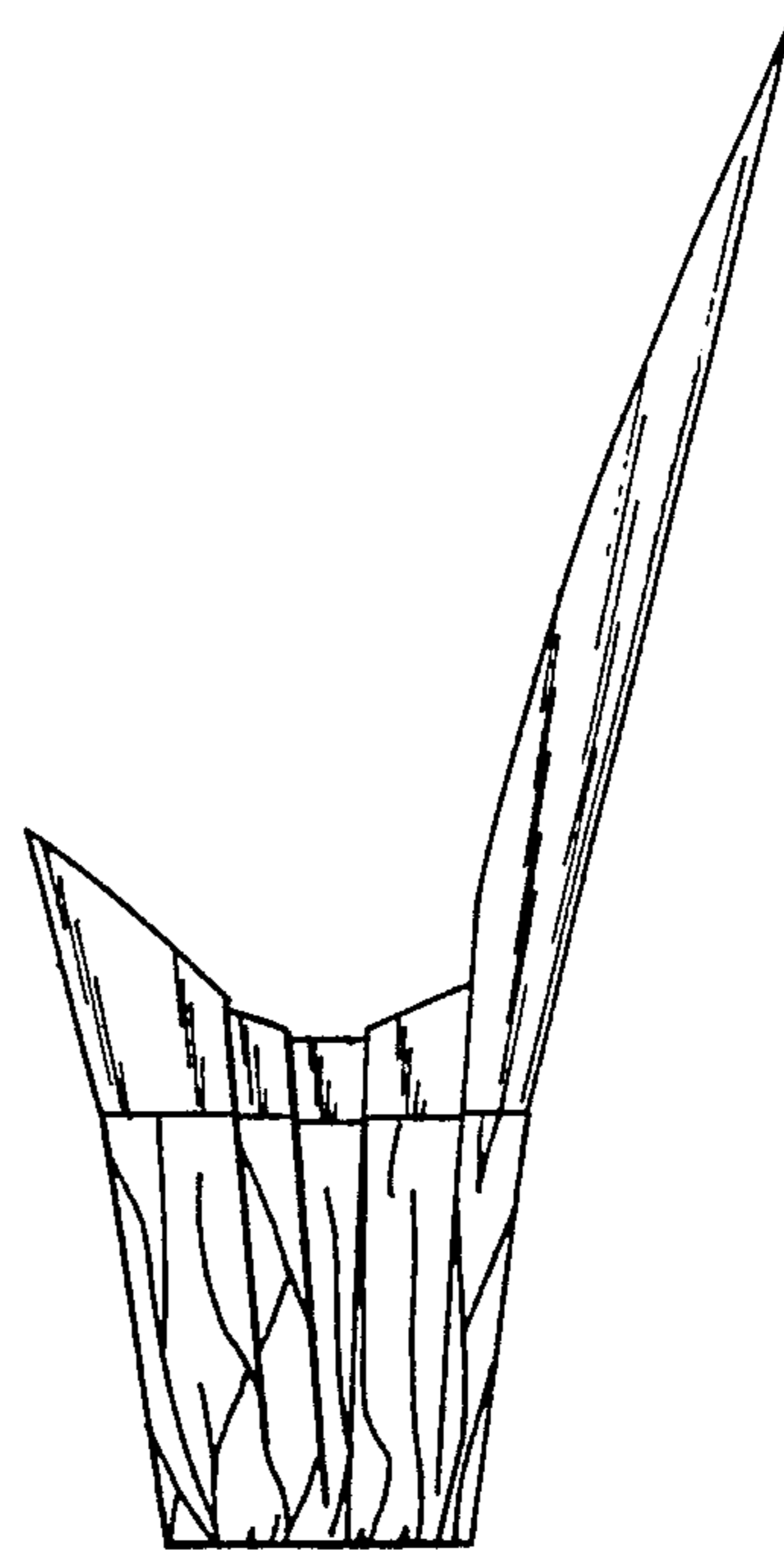

FIG. 12

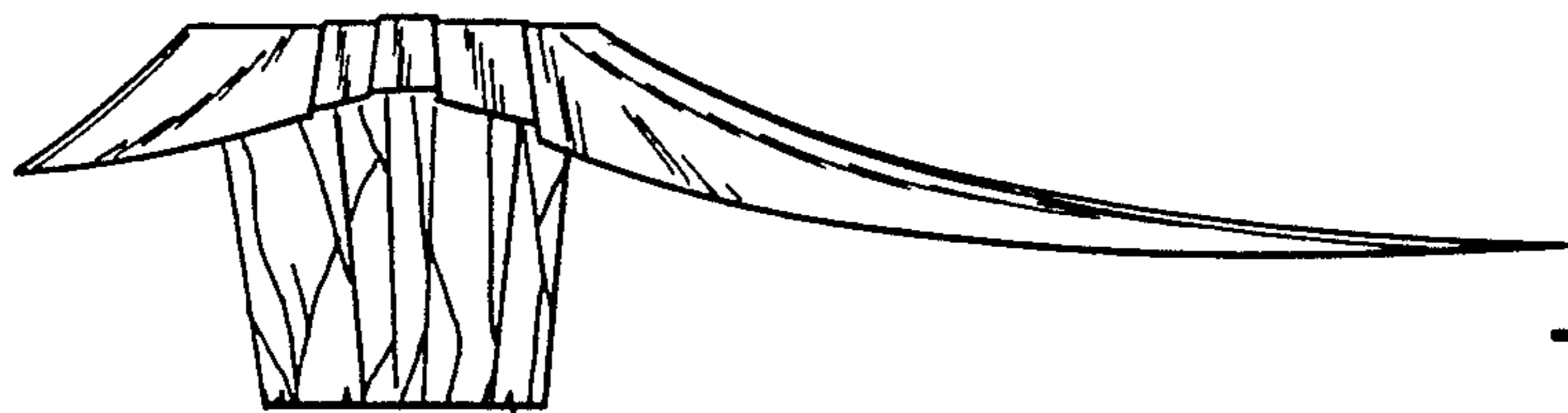

FIG. 13

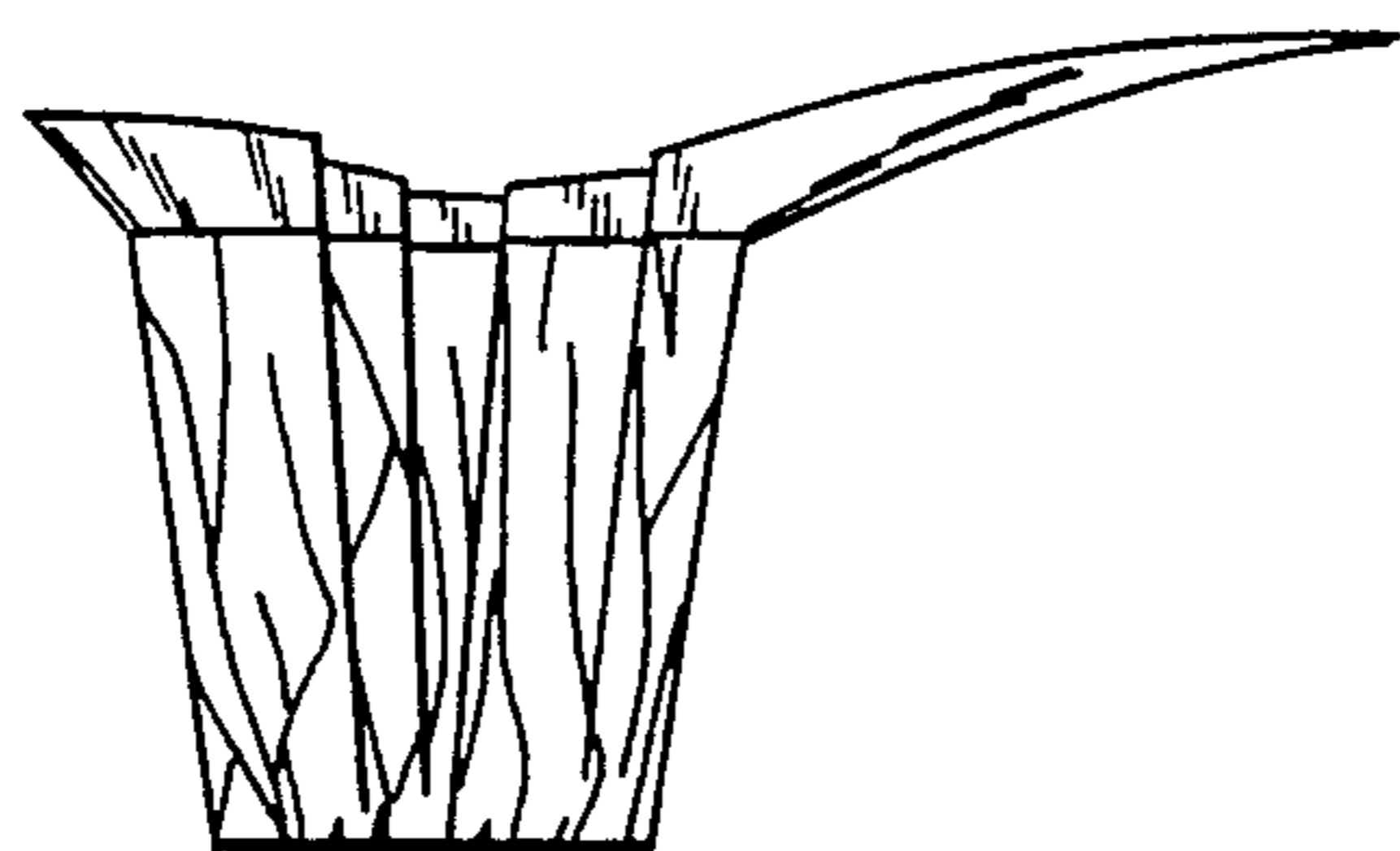

FIG. 14

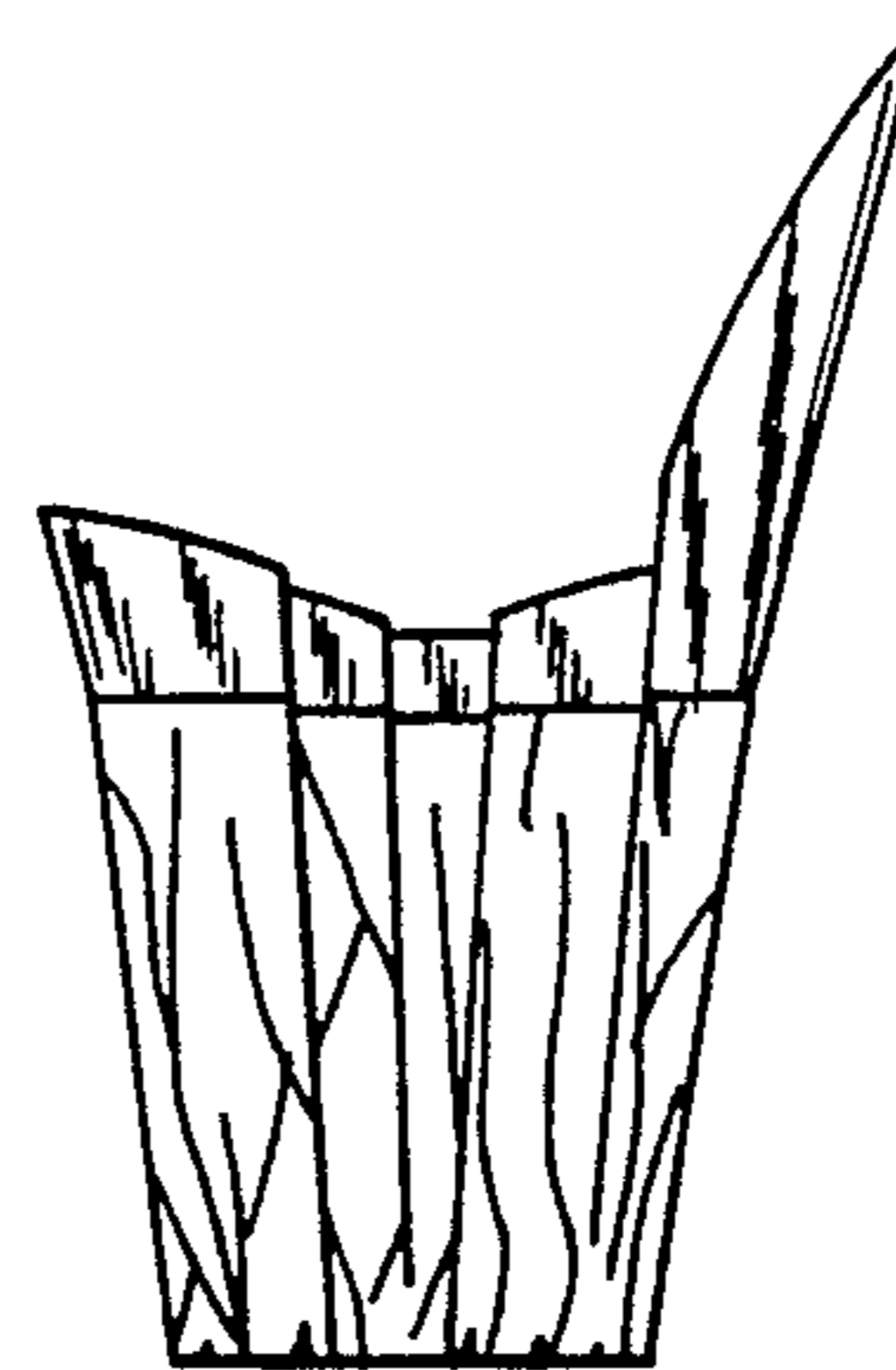

FIG. 15

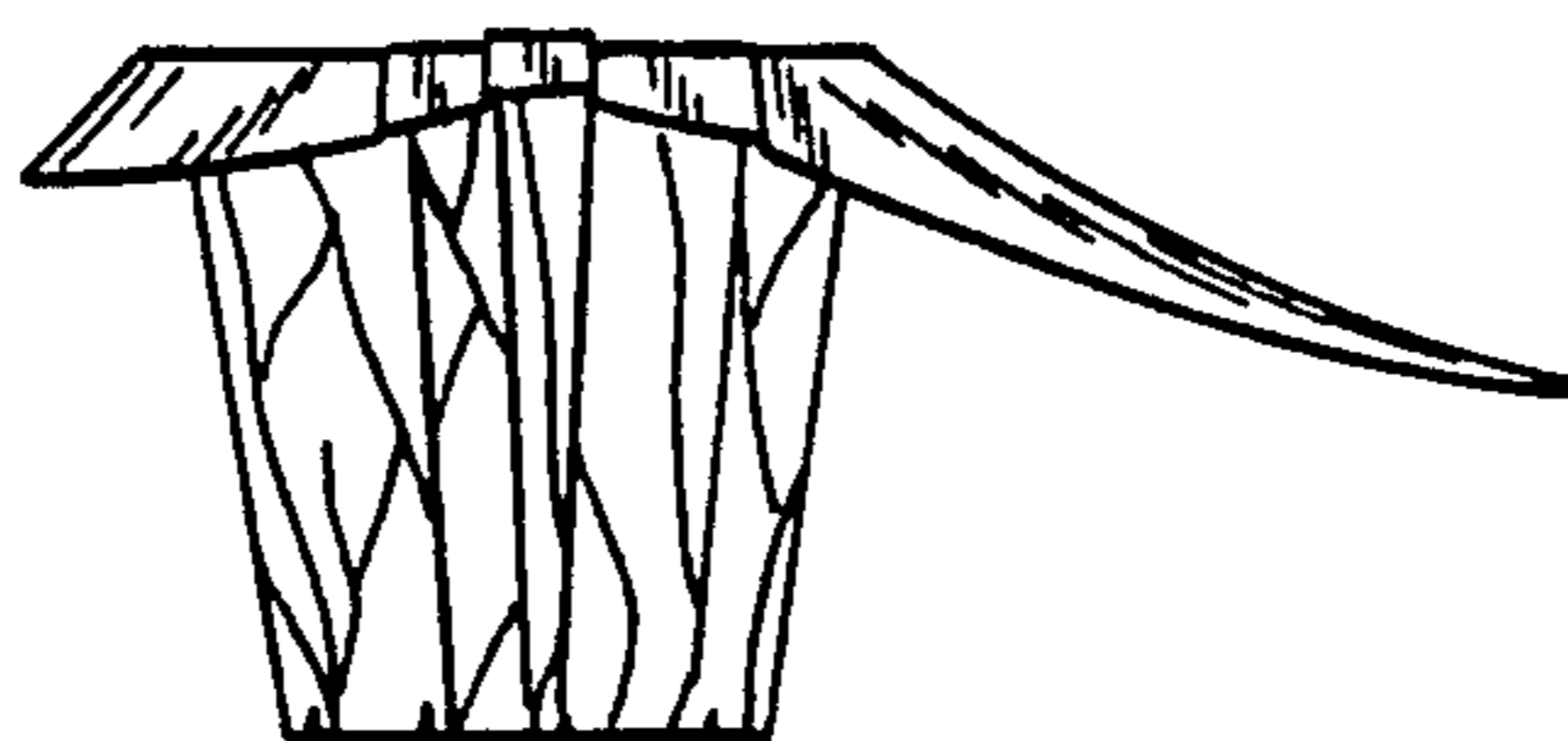

FIG. 16