

[54] BATH TUB

[76] Inventor: Jean-Claude Delepine, 23, Rue Clapeyron, 75008 Paris, France

[\*\*] Term: 14 Years

[21] Appl. No.: 458,827

[22] Filed: Dec. 29, 1989

[30] Foreign Application Priority Data

Aug. 14, 1989 [IB] Int'l Pat. Institute ..... DM/014356

[52] U.S. Cl. .... D23/281

[58] Field of Search ..... D23/270-283, D23/303-307; 4/513, 538-544, 546, 559, 571-579, 584, 589, 590, 555; D24/204, 205

[56] References Cited

U.S. PATENT DOCUMENTS

- D. 214,270 5/1969 Bonsack ..... D23/55
- D. 225,225 11/1972 Russell ..... D23/279
- D. 234,547 3/1975 Nicollet ..... D83/1 C
- D. 237,183 10/1975 Bonsack ..... D23/281
- D. 237,616 11/1975 Gordon ..... D23/277
- D. 240,084 5/1976 Melchior ..... D23/55 X
- D. 241,643 9/1976 Bonsack ..... D23/55
- D. 250,828 1/1979 Clement ..... D23/55
- D. 250,829 1/1979 Clement ..... D23/55
- D. 250,830 1/1979 Clement ..... D23/55
- D. 250,962 1/1979 Bonsack ..... D23/55
- D. 253,124 10/1979 Primault ..... D23/277
- D. 253,367 11/1979 Weaver ..... D23/55
- D. 254,387 3/1980 Ogden ..... D23/55
- D. 260,288 8/1981 D'Innocente et al. .... D24/38
- D. 260,429 8/1981 Myers ..... D24/38
- D. 264,505 5/1982 Reineman ..... D24/38
- D. 267,198 12/1982 Huguet ..... D24/38
- D. 267,271 12/1982 Kingsley et al. .... D24/38

- D. 271,522 11/1983 Wiley ..... D24/38
- D. 274,835 7/1984 Gruber ..... D23/55
- D. 276,362 11/1984 Griffiths ..... D23/281
- D. 277,985 3/1985 Kingsley ..... D24/38
- D. 284,890 7/1986 Delepine ..... D24/38
- D. 286,811 11/1986 Diamond ..... D23/55
- D. 287,620 1/1987 Delepine ..... D24/38
- D. 290,390 6/1987 Diamond ..... D23/69
- D. 290,995 7/1987 Diamond ..... D23/69
- 1,284,171 11/1918 Barnhart .
- 1,315,643 9/1919 Schwartz .
- 1,940,514 12/1933 Steinkamp ..... 14/590
- 1,962,076 10/1933 Jadkowski ..... 4/173
- 2,529,568 11/1950 O'Hara ..... 4/173
- 2,569,825 10/1951 Otis ..... 5/590
- 4,339,833 7/1982 Mandell ..... 4/542
- 4,466,141 8/1984 Starkey ..... 4/488

FOREIGN PATENT DOCUMENTS

- 418820 3/1947 Italy ..... 4/584

Primary Examiner—Susan J. Lucas

Attorney, Agent, or Firm—Fisher, Christen & Sabol

[57] CLAIM

The ornamental design for the bath tub, as shown and described.

DESCRIPTION

- FIG. 1 is a top plan view of a bath tub showing my new design;
- FIG. 2 is a side elevational view thereof, the opposite side being a mirror image;
- FIG. 3 is a rear elevational view thereof;
- FIG. 4 is a front elevational view thereof;
- FIG. 5 is a cross-sectional view as taken along line 5—5 of FIG. 1;
- FIG. 6 is a bottom plan view thereof;
- FIG. 7 is a top perspective view thereof.

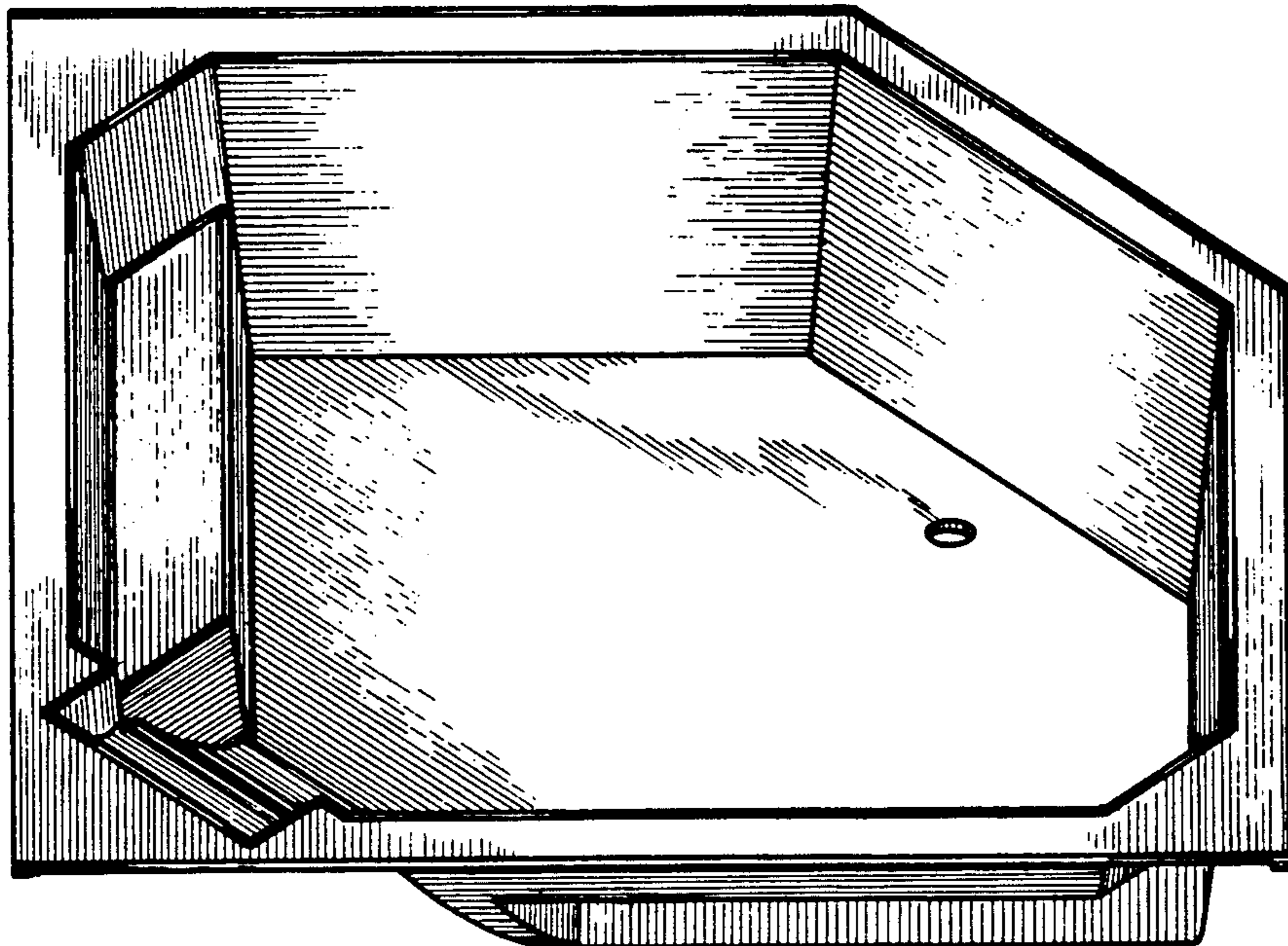

FIG. 1

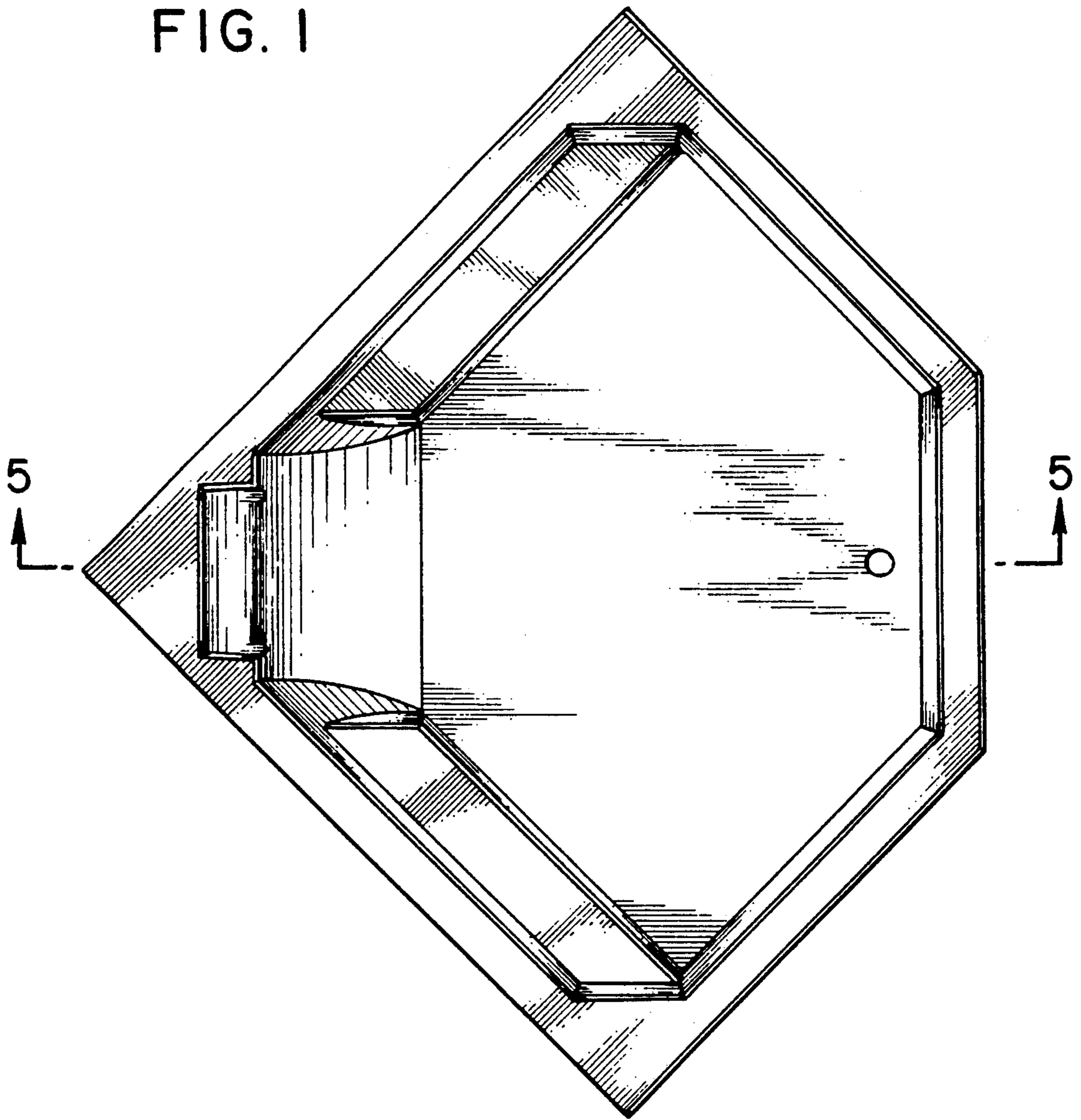

FIG. 2

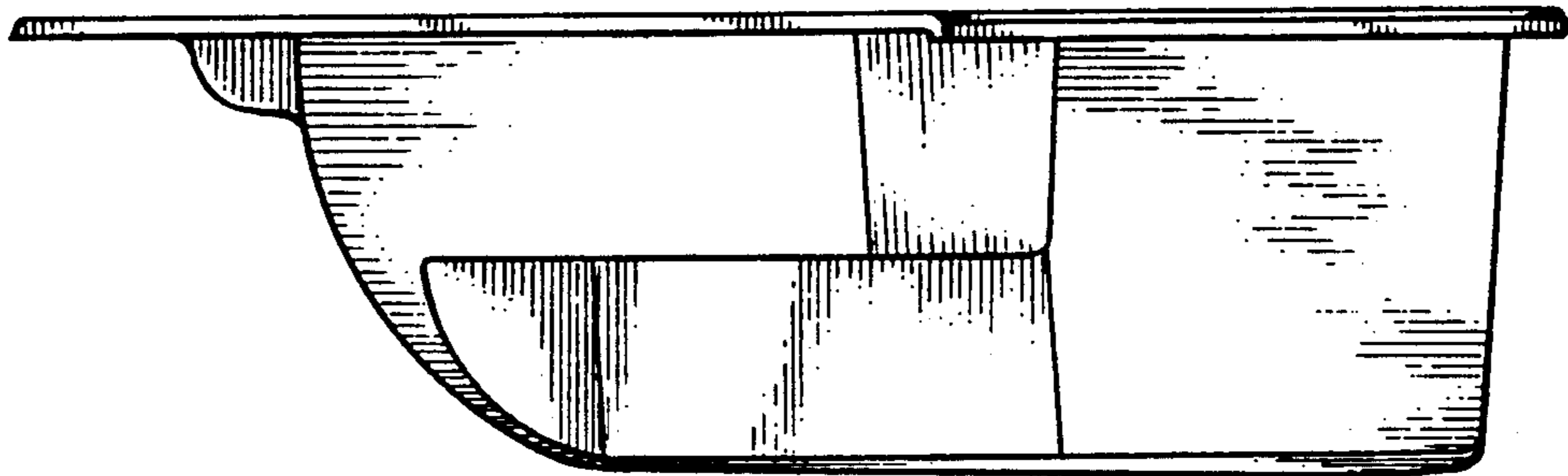

FIG. 3

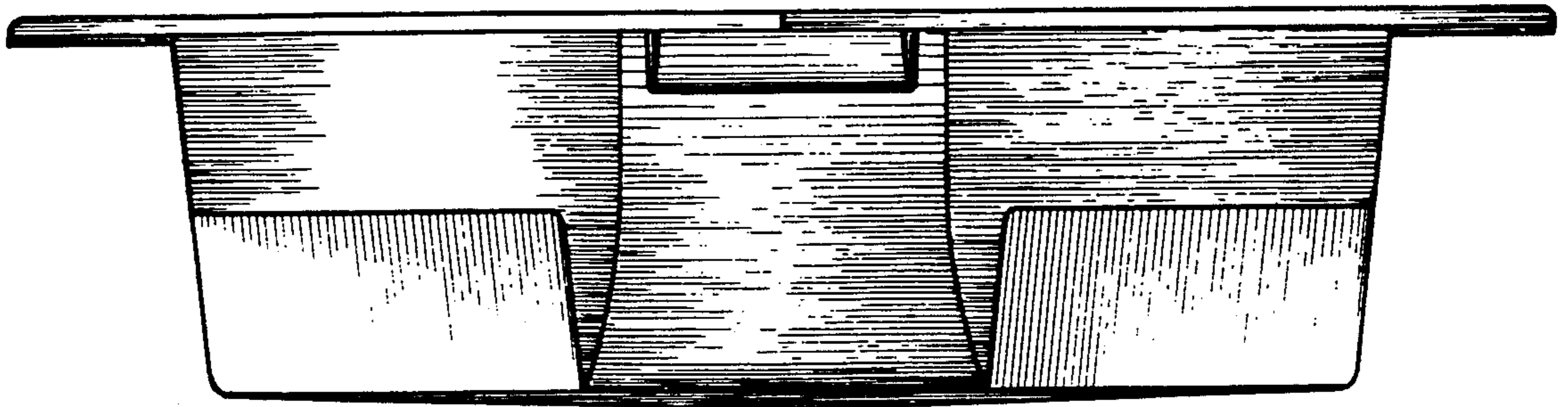

FIG. 4

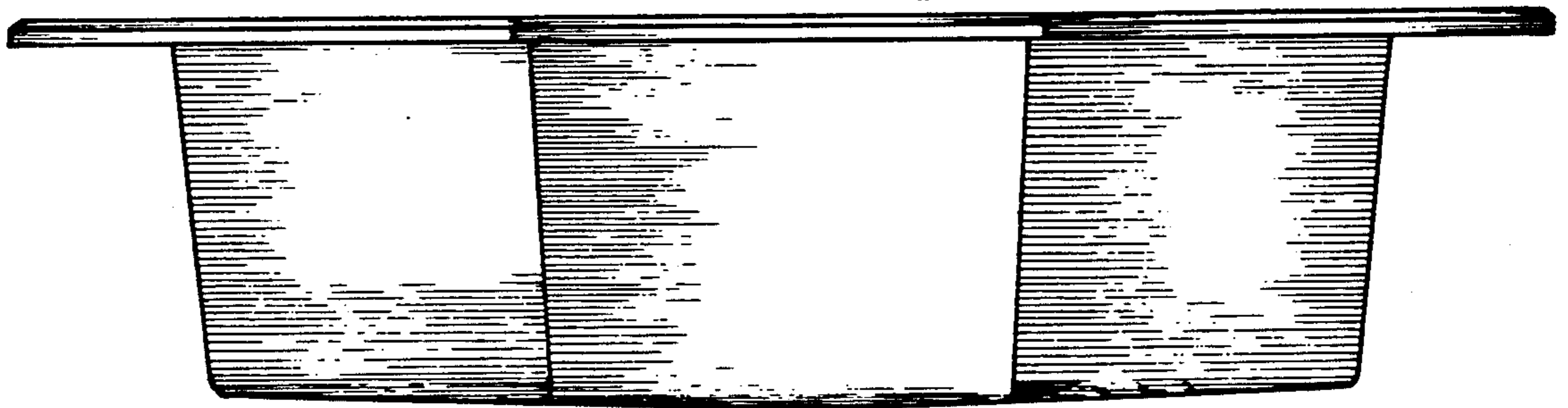

FIG. 5

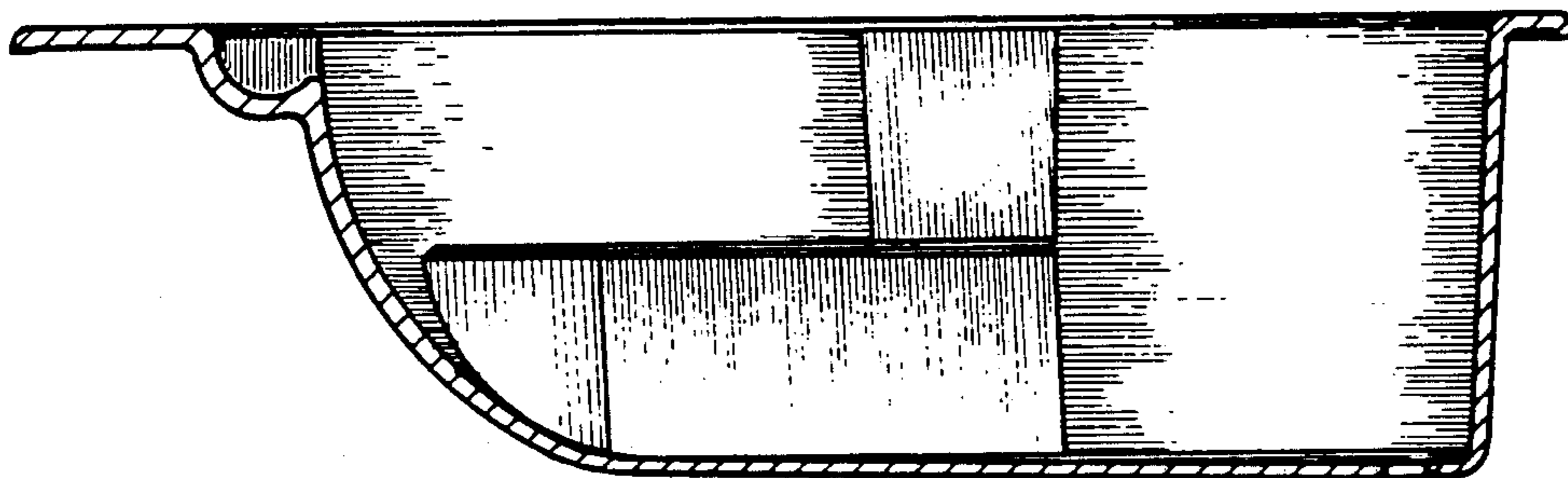

FIG. 6

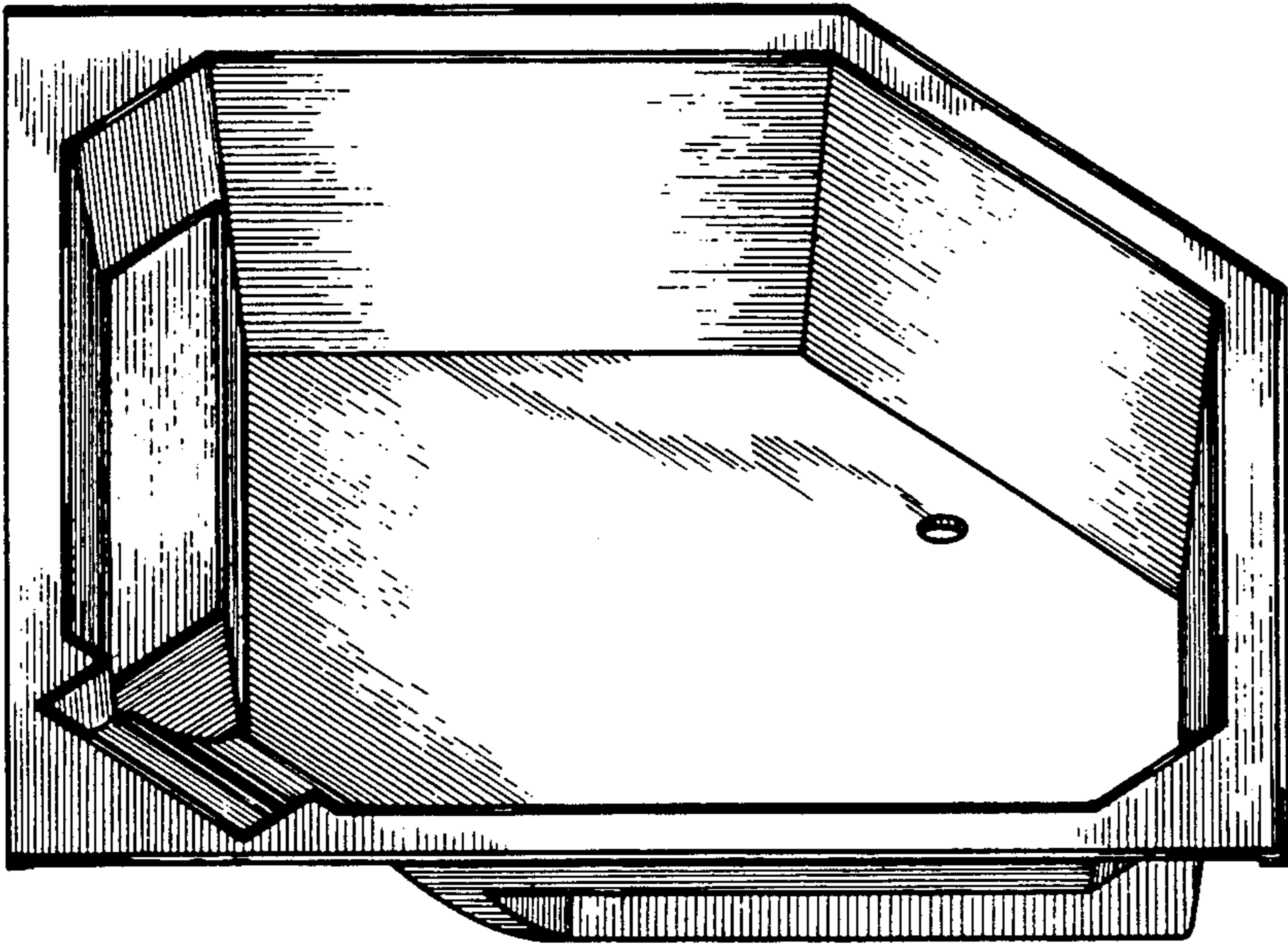
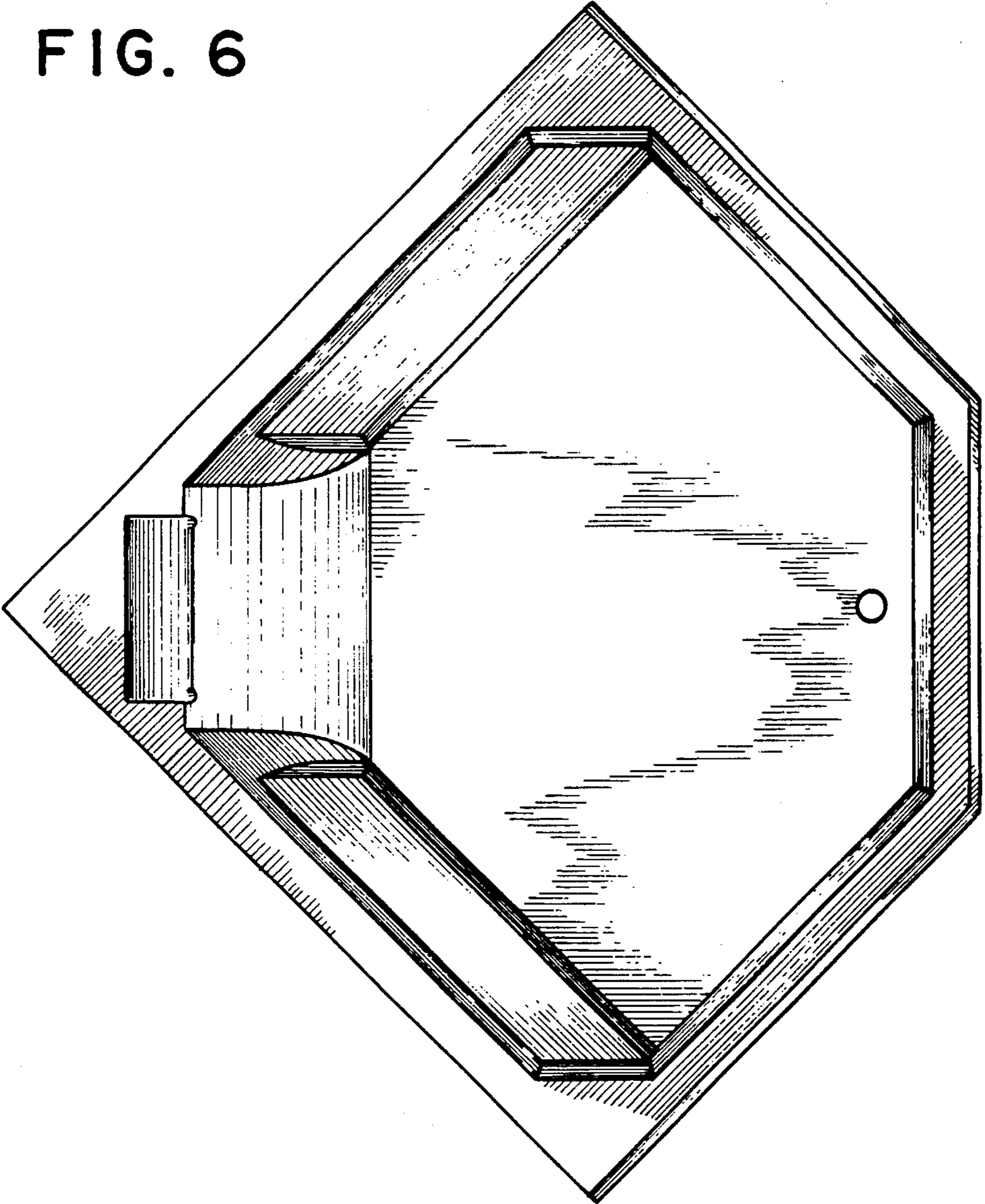

FIG. 7