

[54] DUMBBELL

[76] Inventor: John J. Leonesio, 6750 Kepler Rd., Clinton, Ohio 44216

[**] Term: 14 Years

[21] Appl. No.: 372,521

[22] Filed: Jun. 28, 1989

[52] U.S. Cl. D21/197

[58] Field of Search D21/191-199; 272/93, 119, 122, 123, 125, 143

[56] References Cited

U.S. PATENT DOCUMENTS

D. 213,119	1/1969	Burns	D21/195
D. 244,628	6/1977	Wright	D21/197
D. 274,283	6/1984	Wright	D21/197
D. 307,168	4/1990	Vodhanel	D21/195

Primary Examiner—Charles A. Rademaker

Attorney, Agent, or Firm—Daniel J. Hudak Co.

[57] CLAIM

The ornamental design for a dumbbell, as shown and described.

DESCRIPTION

FIG. 1 is a perspective view of a dumbbell showing my new design;

FIG. 2 is a top plan view thereof;

FIG. 3 is a bottom plan view thereof;

FIG. 4 is a front elevational view thereof;

FIG. 5 is a rear elevational view thereof;

FIG. 6 is a right side elevational view thereof, the side opposite being a mirror image;

FIG. 7 is another right side elevational view thereof with portions of the side wall broken away;

FIG. 8 is a cross-sectional view thereof taken along line 8—8 in FIG. 6; and,

FIG. 9 is a perspective view of a modified embodiment of the design shown in FIGS. 1 through 8.

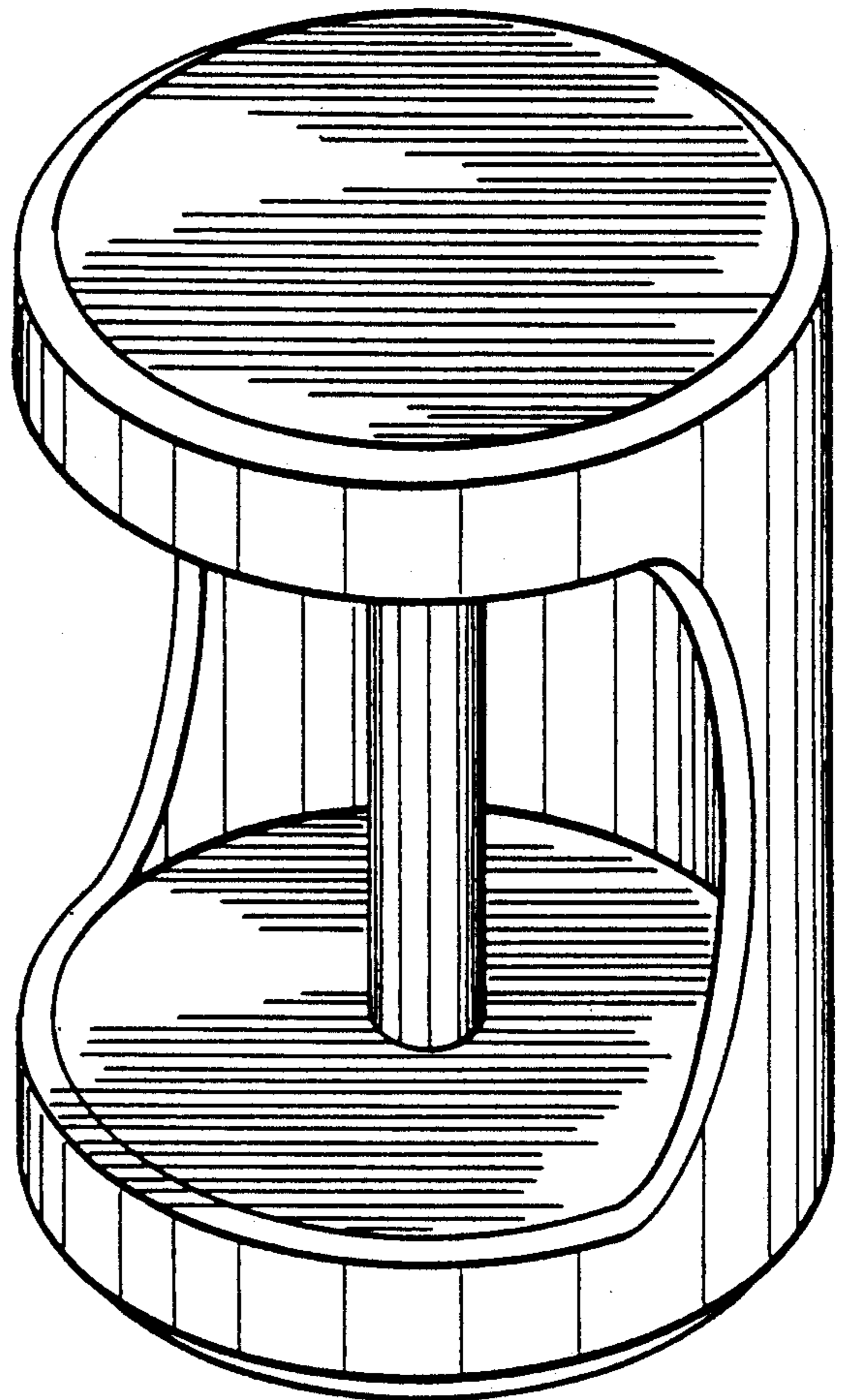
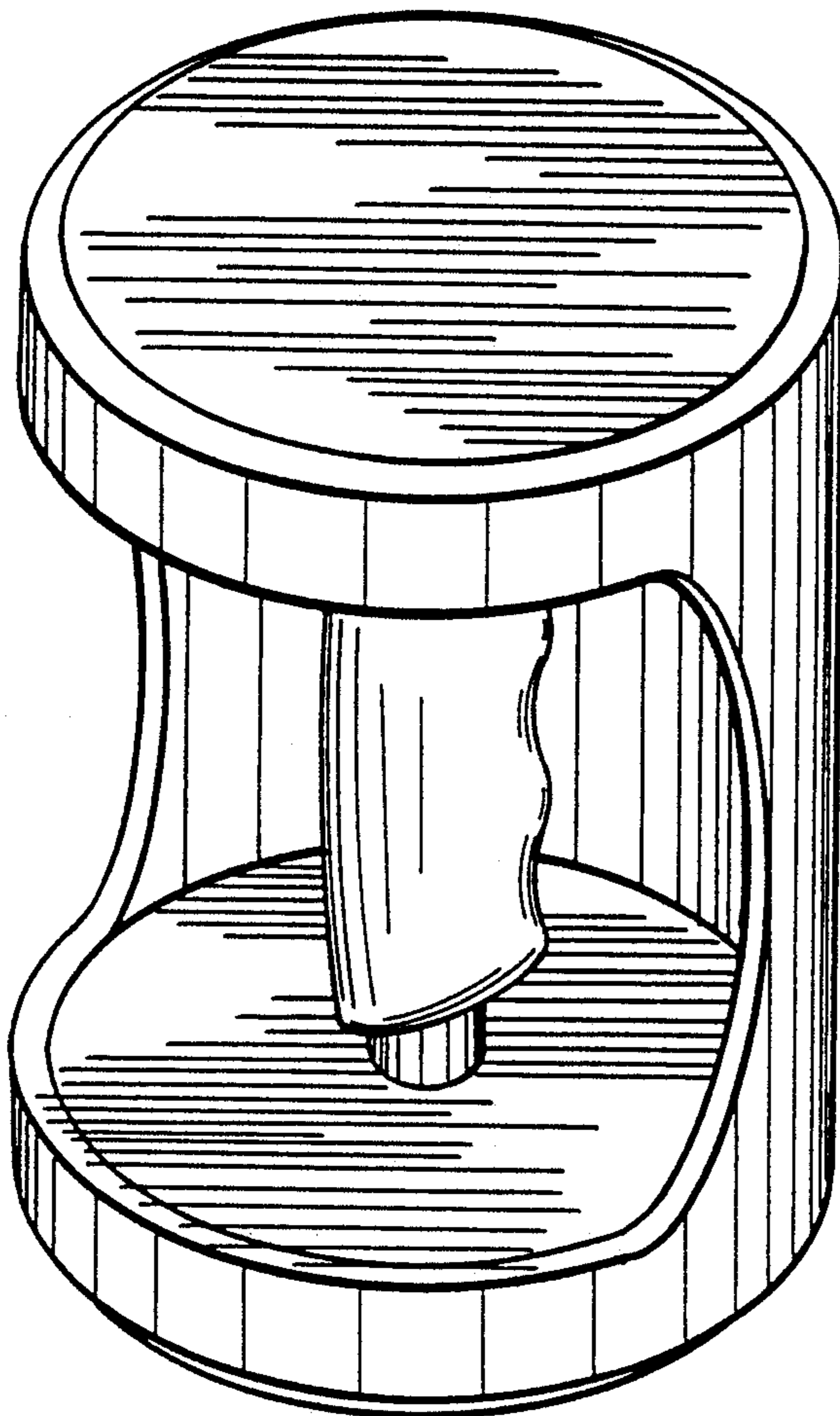

FIG. 1

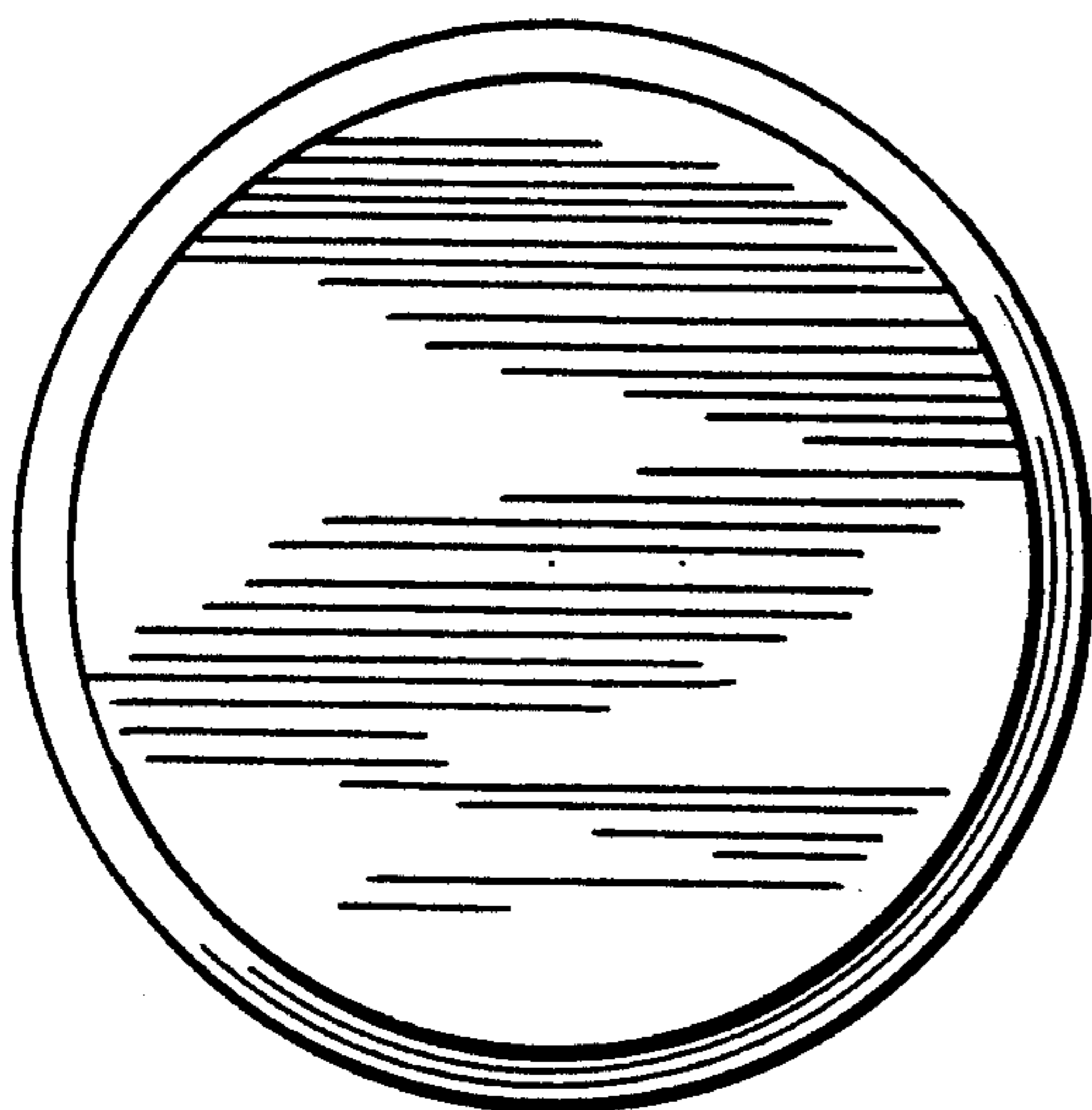
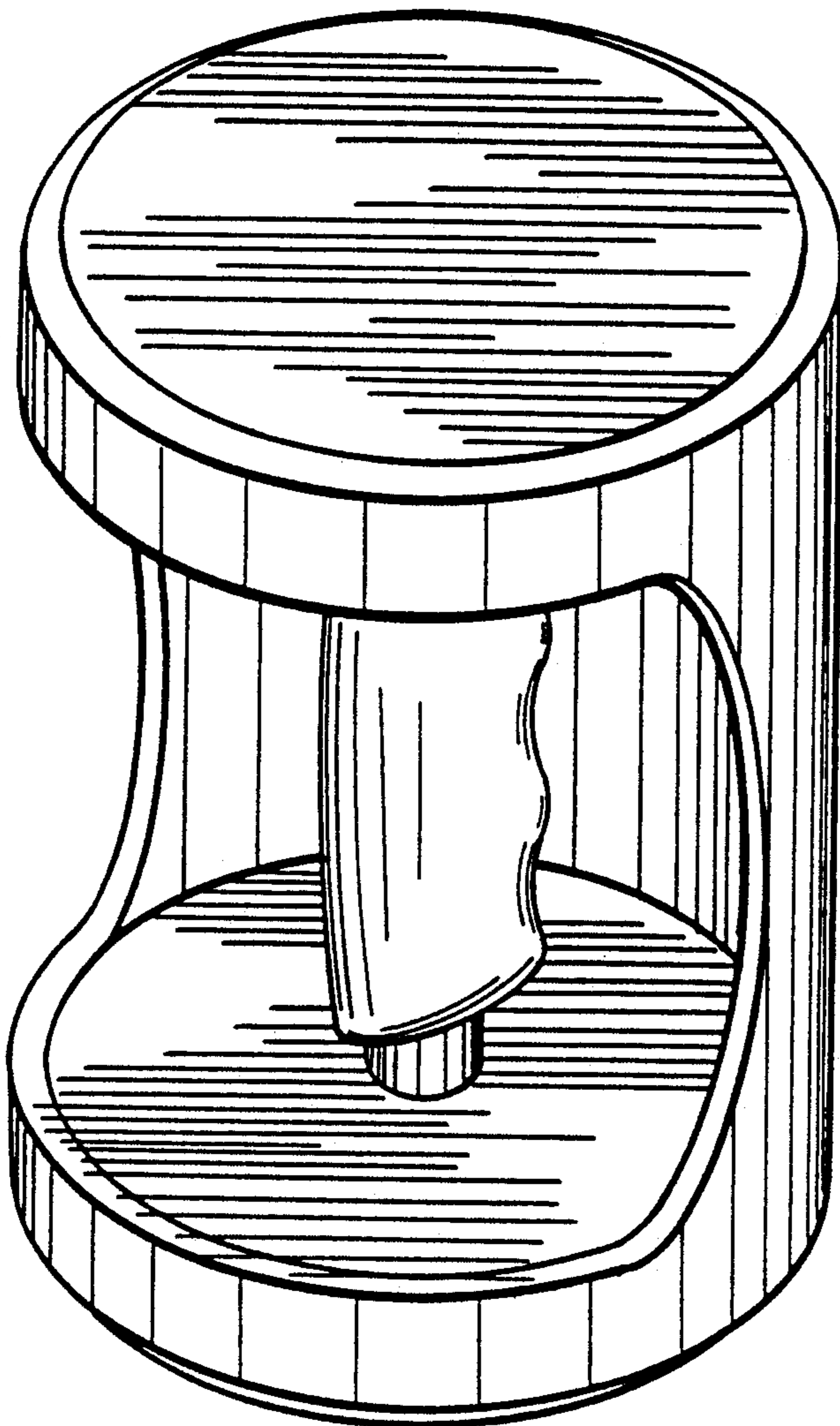

FIG. 2

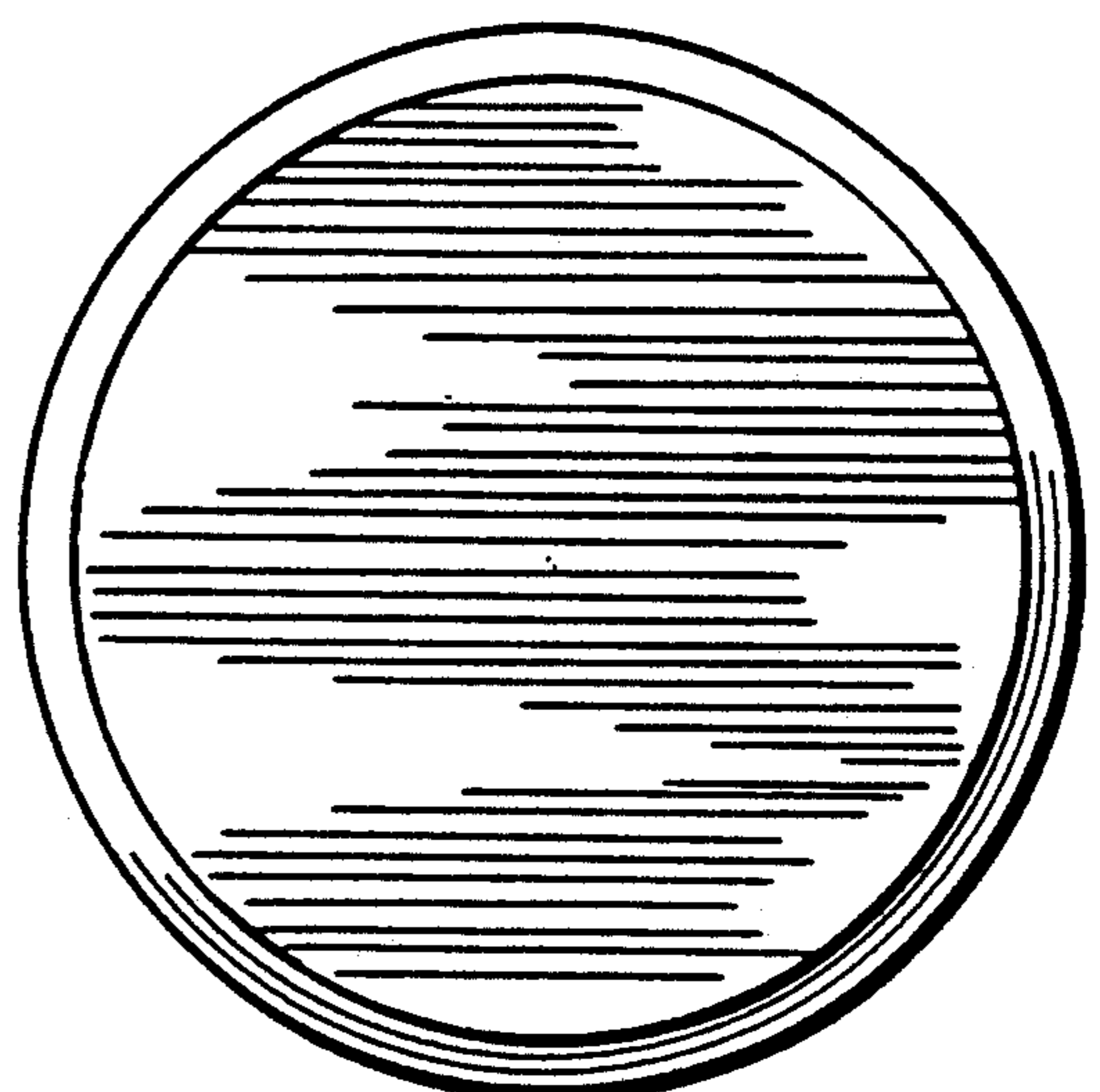

FIG. 3

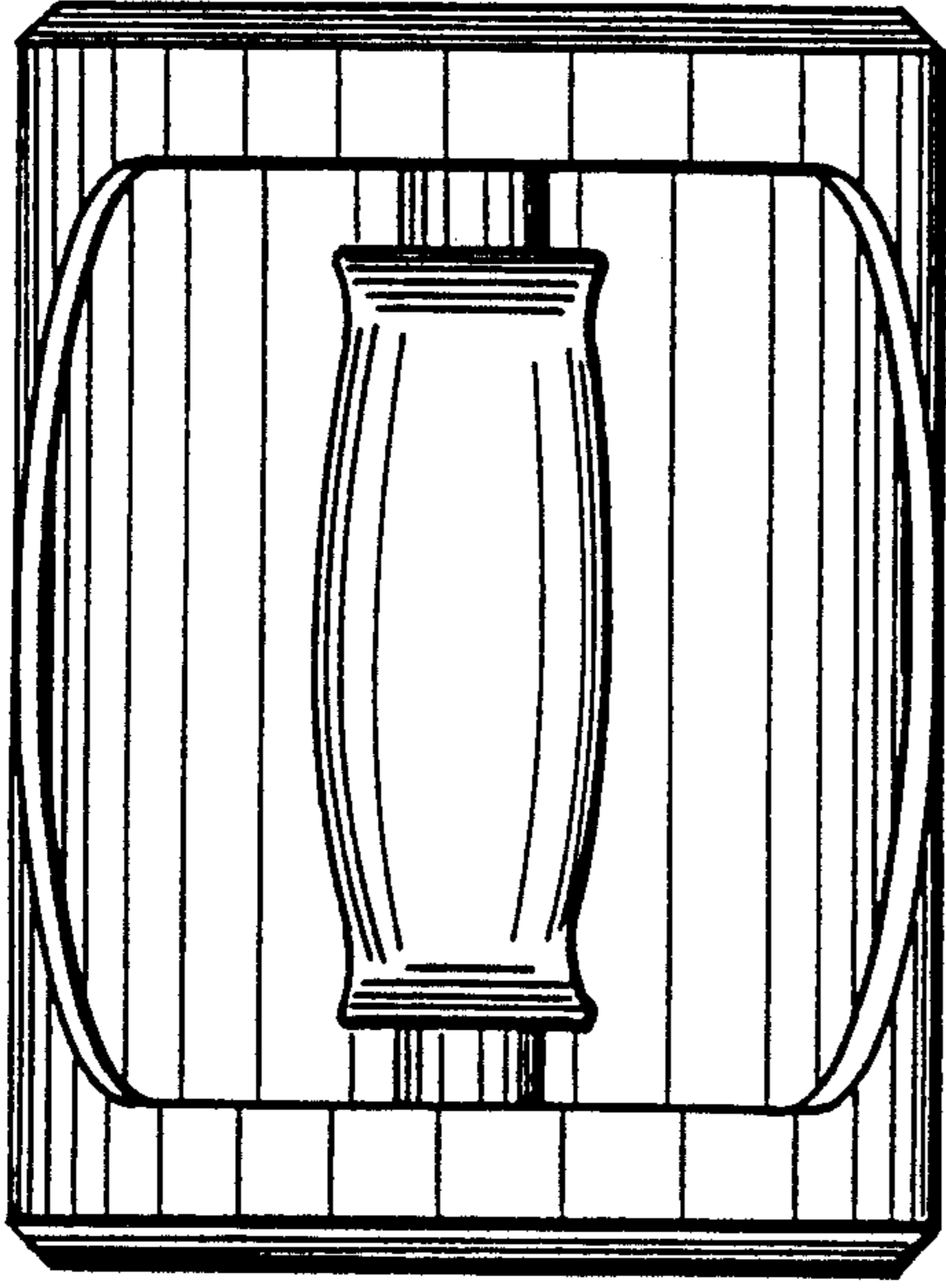

FIG. 4

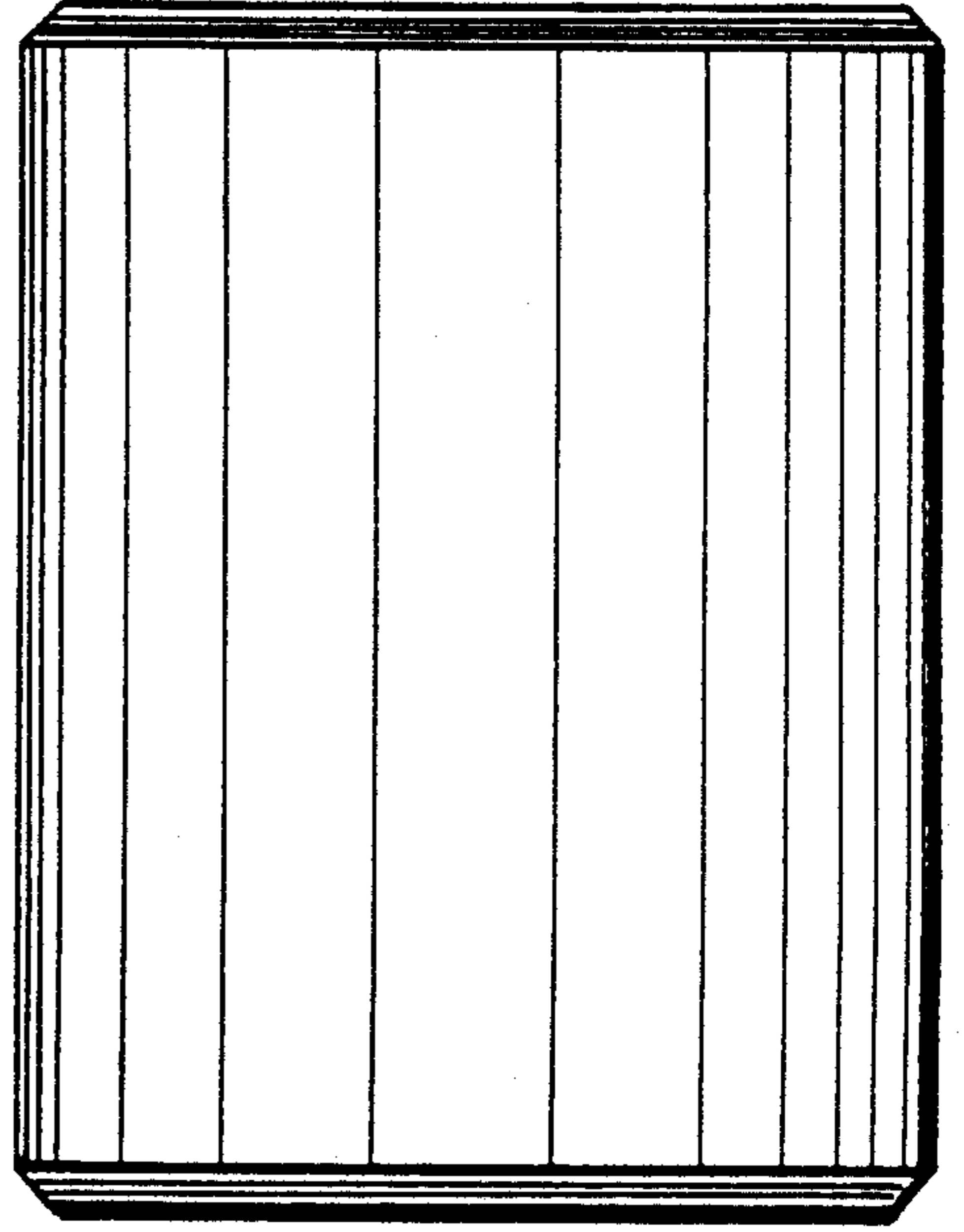

FIG. 5

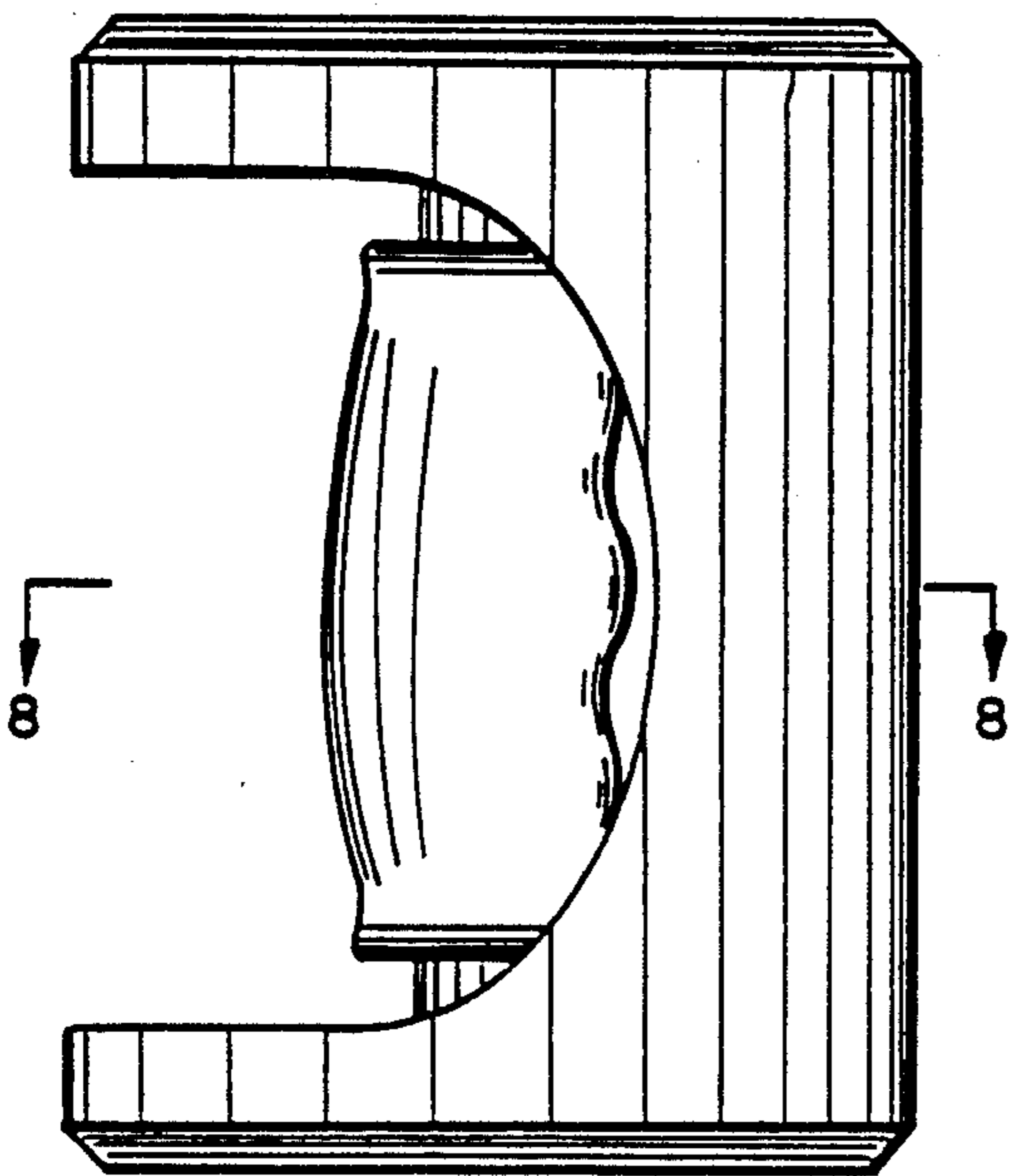

FIG. 6

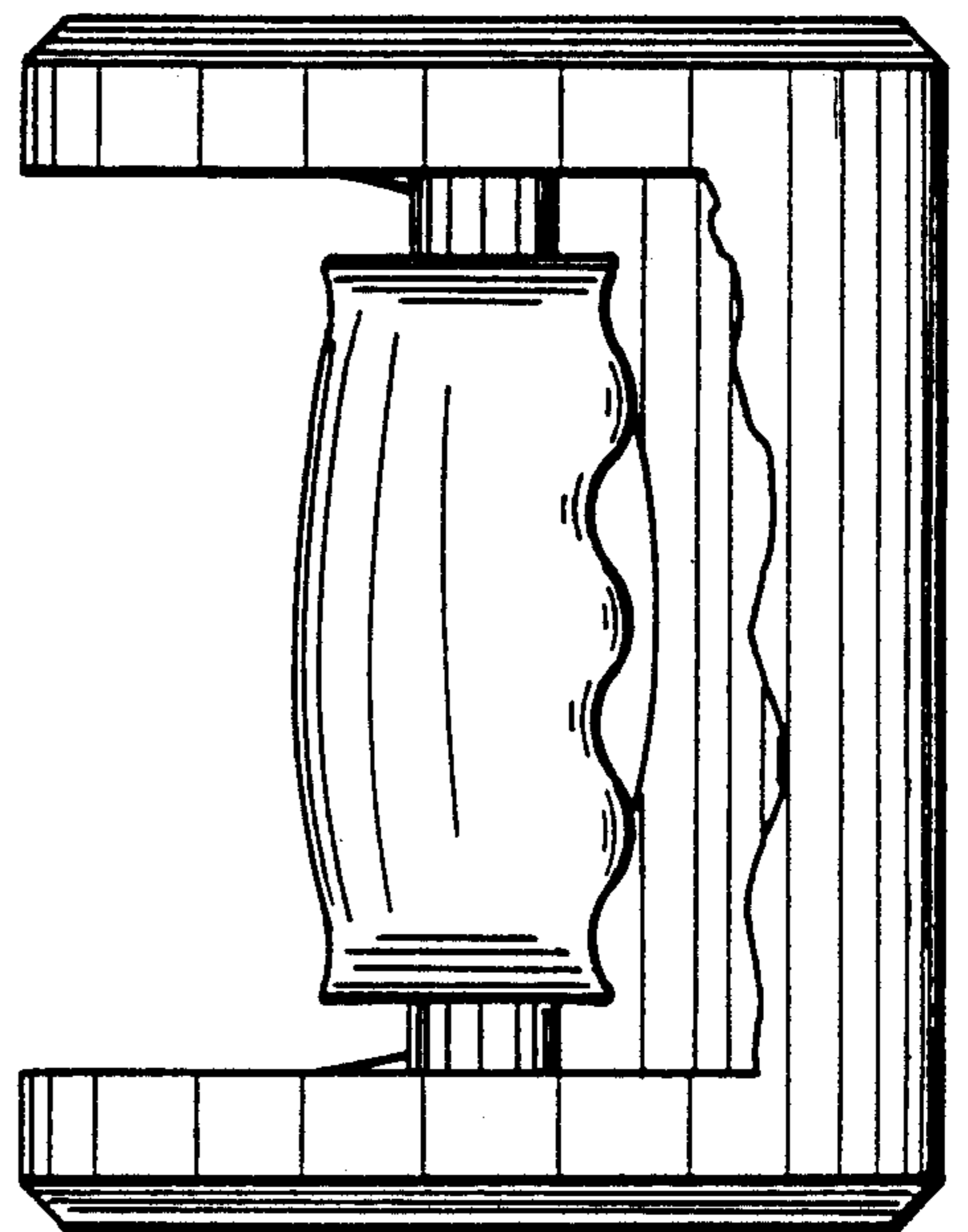

FIG. 7

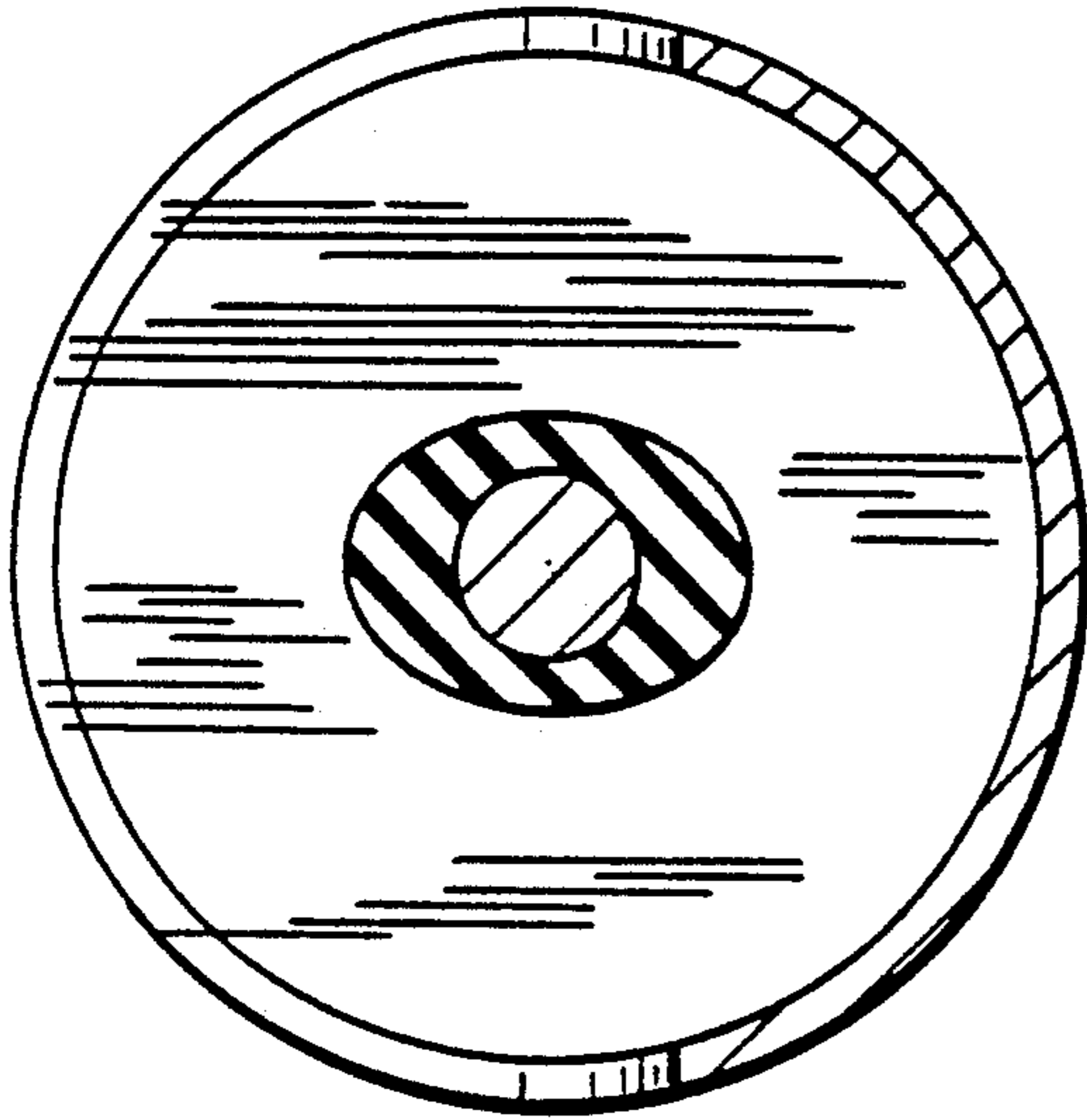

FIG. 8

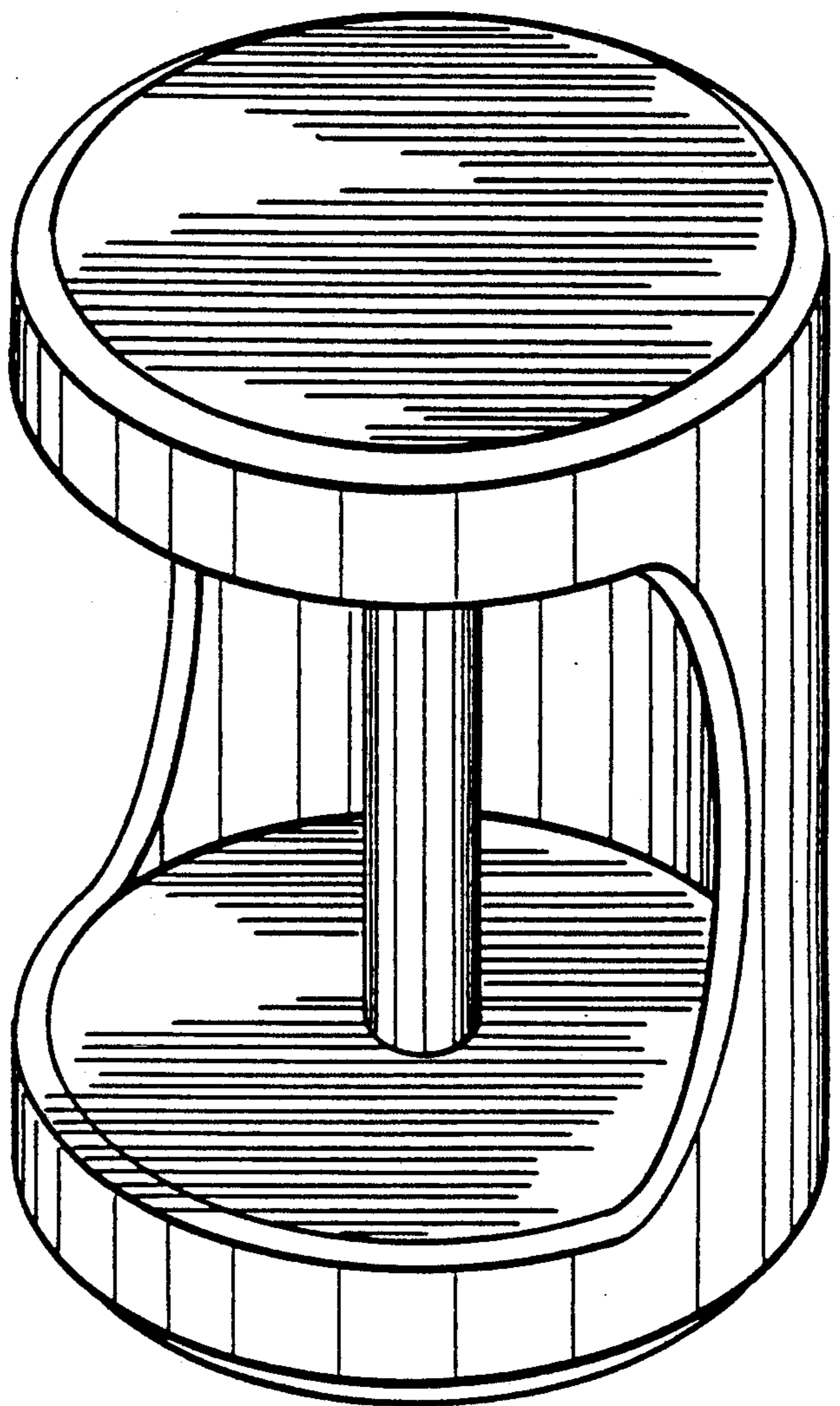

FIG. 9