

[54] DIGITAL AUDIO DISC PLAYER

D. 315,348 3/1991 Wada D14/156
D. 315,905 4/1991 Ito et al. D14/136 X

[75] Inventors: Masafumi Ito, Tokyo; Shigeru Hasegawa, Kodaira; Minoru Sube, Hachioji; Katsuhiko Takashima, Yokohama, all of Japan

OTHER PUBLICATIONS

Stereo Sound Magazine (two pages), Jan. 1988.

[73] Assignee: Teac Corporation, Japan

Primary Examiner—Theodore M. Shooman
Attorney, Agent, or Firm—Andrus, Scales, Starke & Sawall

[**] Term: 14 Years

[57] CLAIM

[21] Appl. No.: 385,264

The ornamental design for a digital audio disc player, as shown and described.

[22] Filed: Jul. 25, 1989

DESCRIPTION

[30] Foreign Application Priority Data

Sep. 28, 1988 [JP] Japan 63-38019

FIG. 1 is a front elevational view of a digital audio disc player showing our new design;

[52] U.S. Cl. D14/156; D14/135

FIG. 2 is a rear elevational view thereof;

[58] Field of Search D14/124-125,

D14/135-136, 156, 160-162, 164, 168;
369/75.1, 77.1, 77.2

FIG. 3 is a left side elevational view thereof;

FIG. 4 is a right side elevational view thereof;

FIG. 5 is a top plan view thereof;

FIG. 6 is a bottom plan view thereof;

FIG. 7 is a top, front and right side perspective view thereof; and

FIG. 8 is a top, front and right side perspective view thereof, shown with the disc tray drawn out.

[56] References Cited

U.S. PATENT DOCUMENTS

D. 272,063 1/1984 Ekuan D14/156
D. 290,111 6/1987 Kawano et al. D14/156

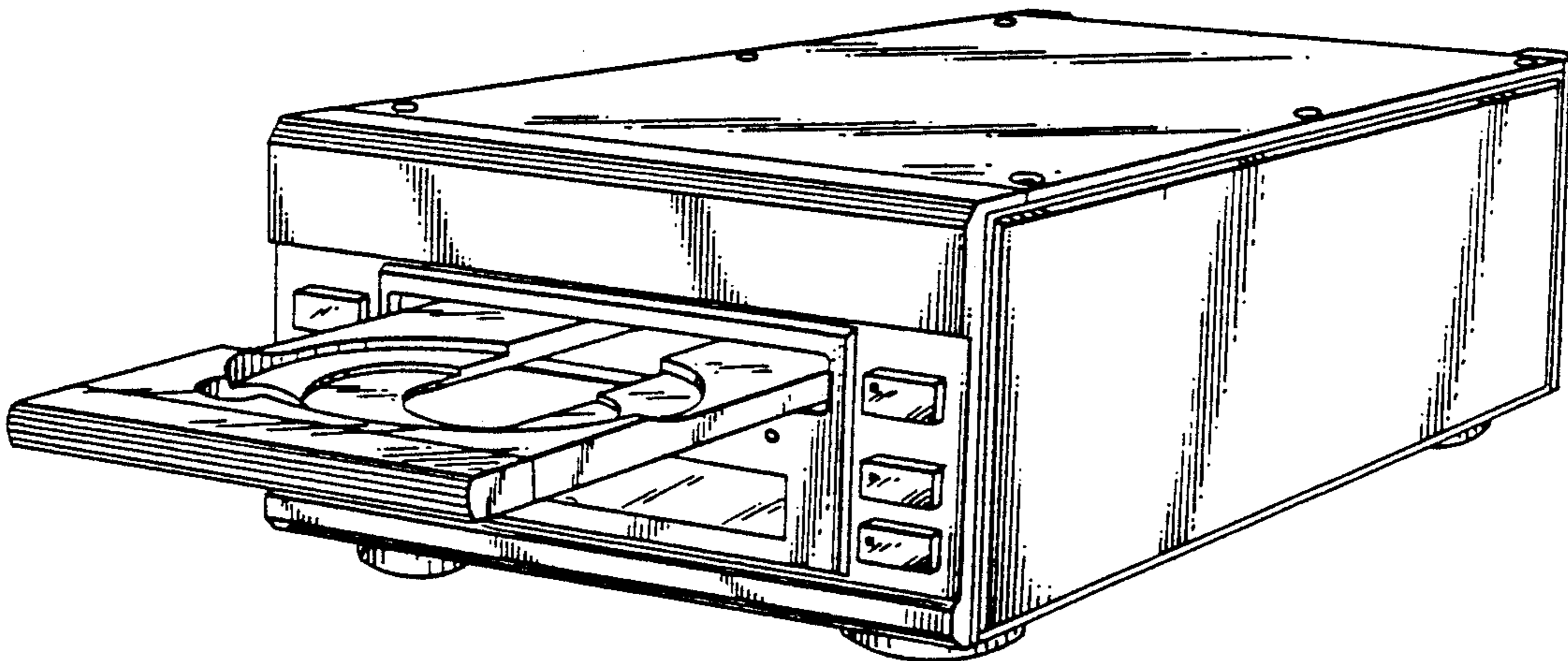
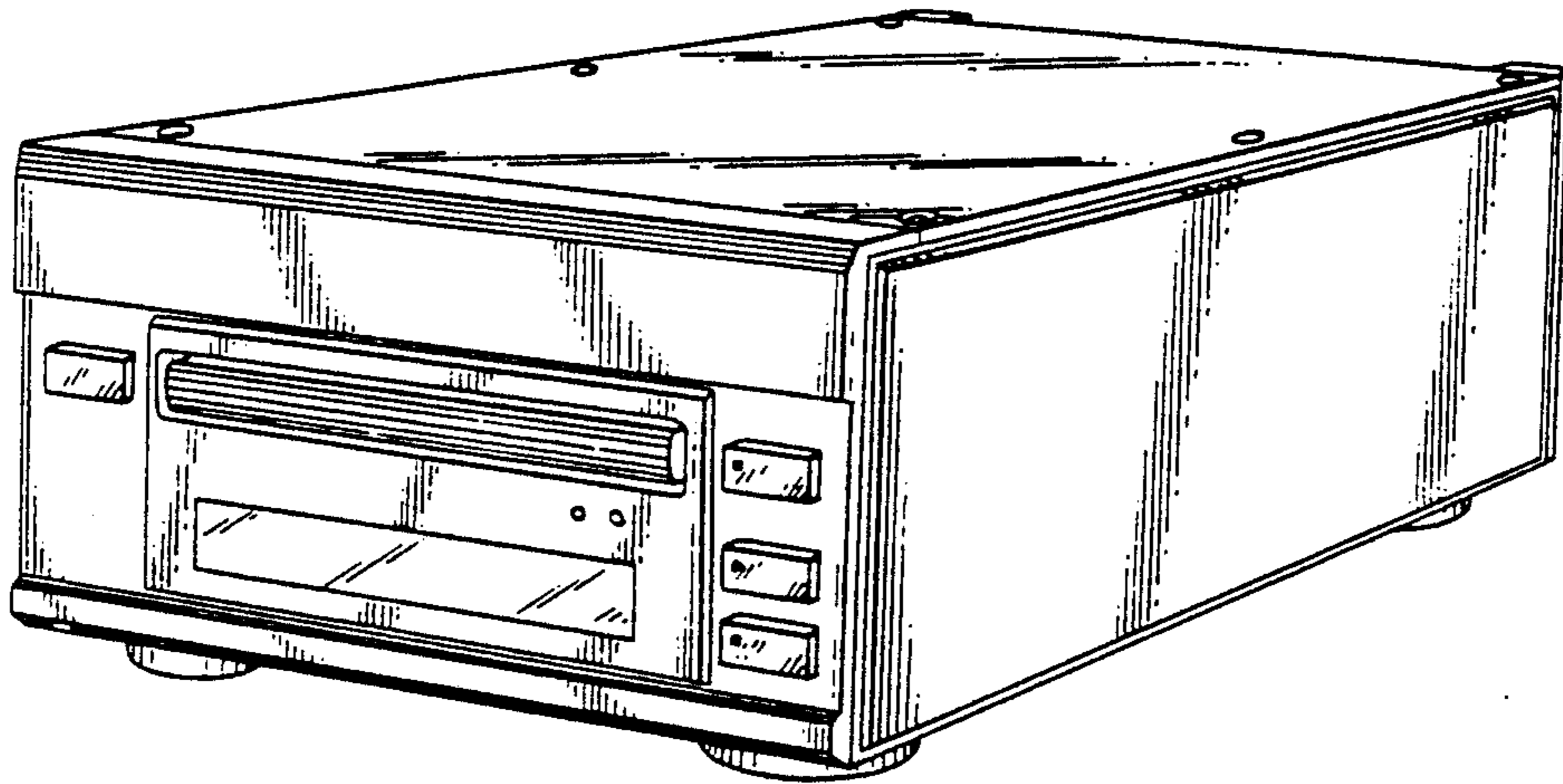

FIG. 1

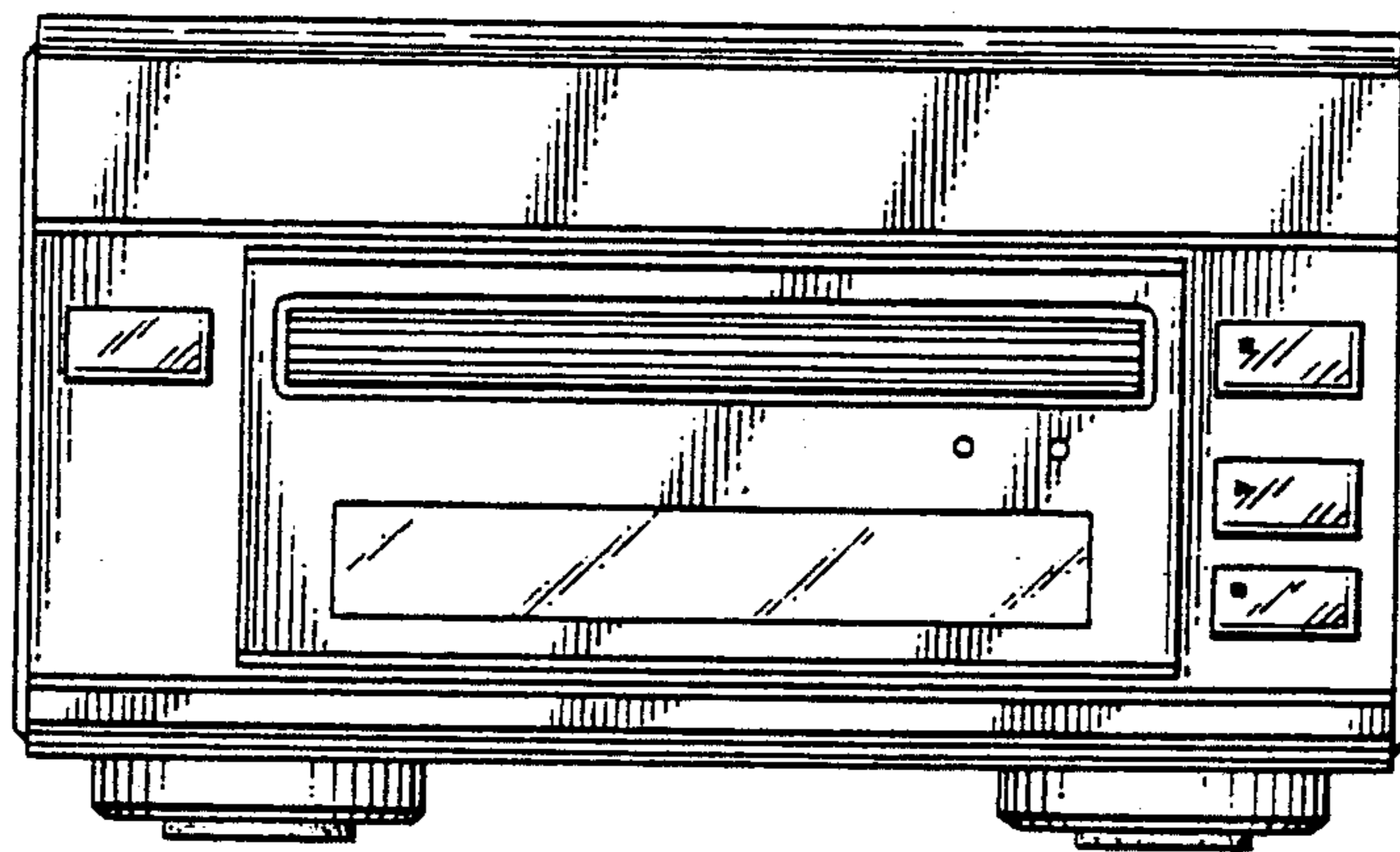

FIG. 2

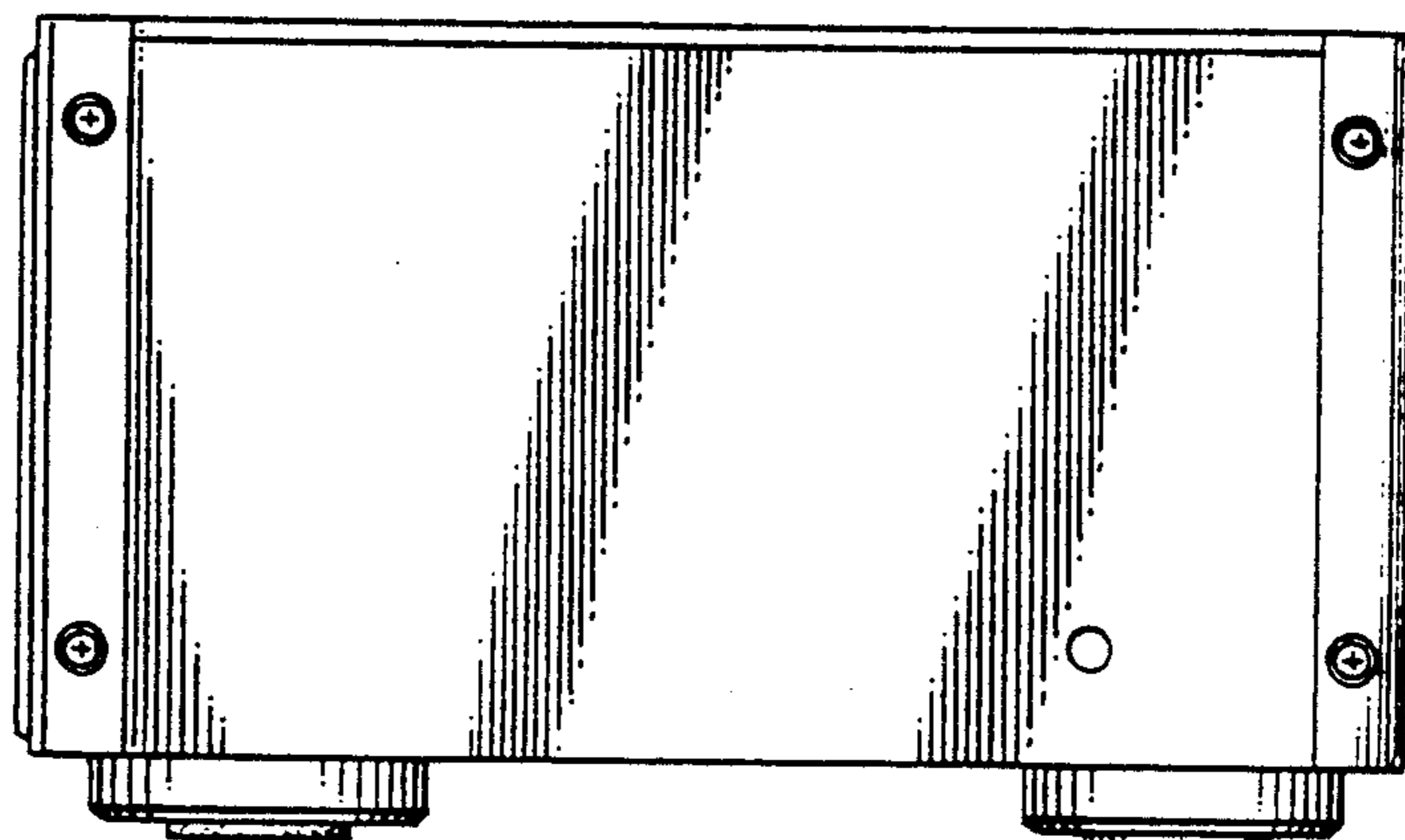

FIG. 3

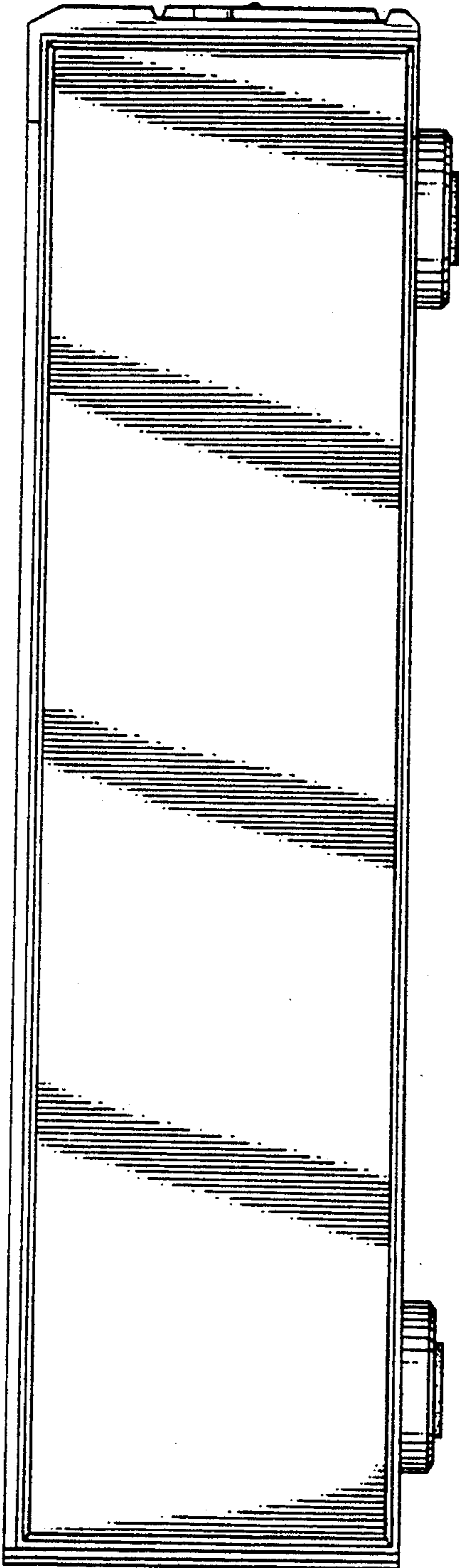

FIG. 4

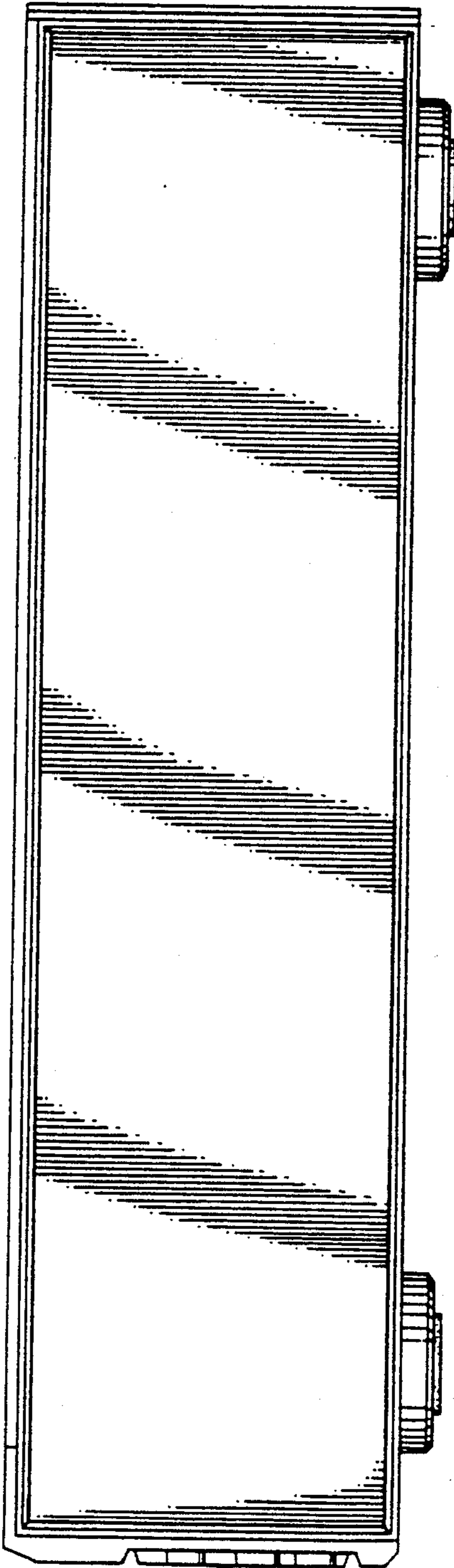

FIG. 5

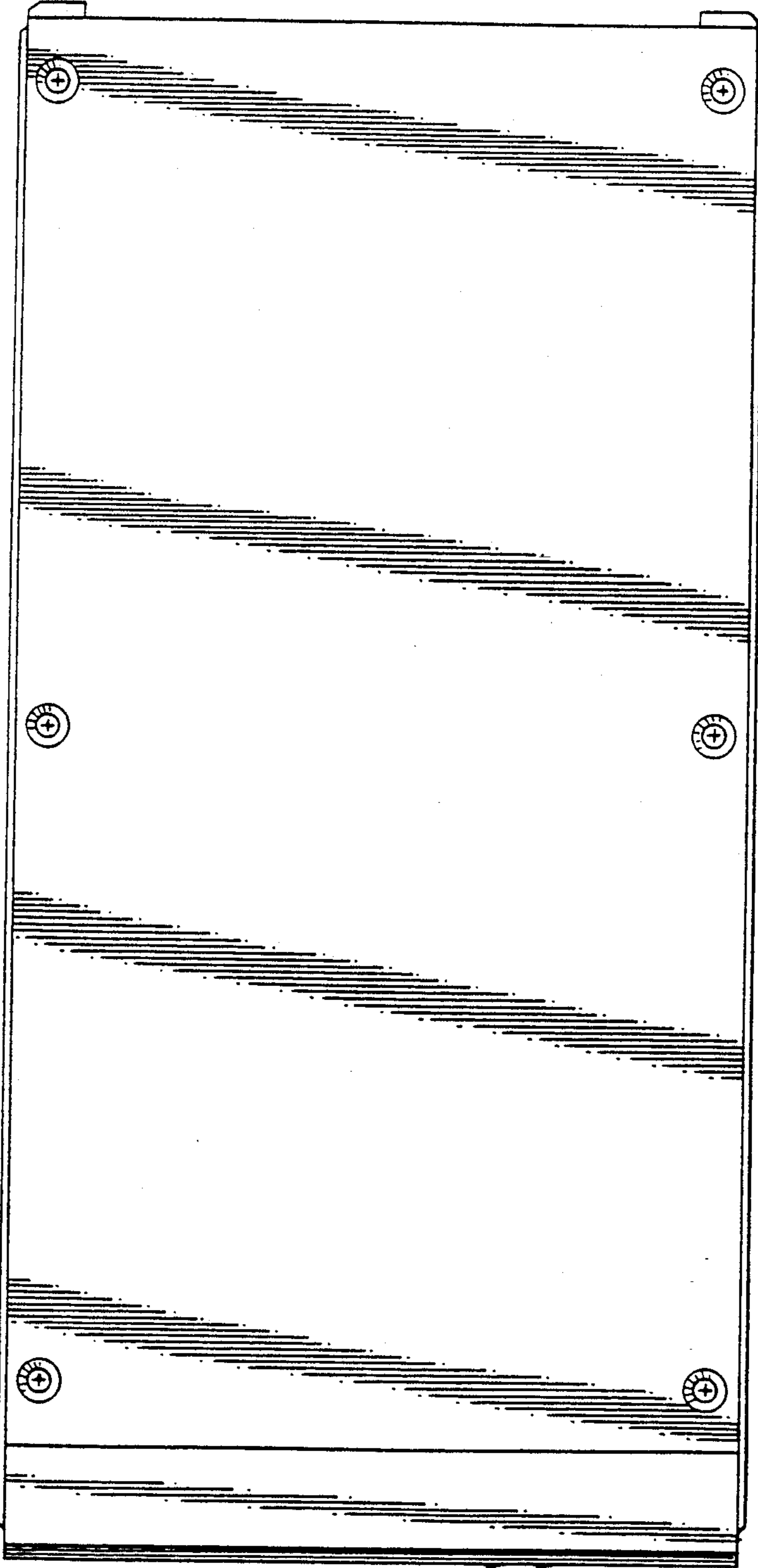

FIG. 6

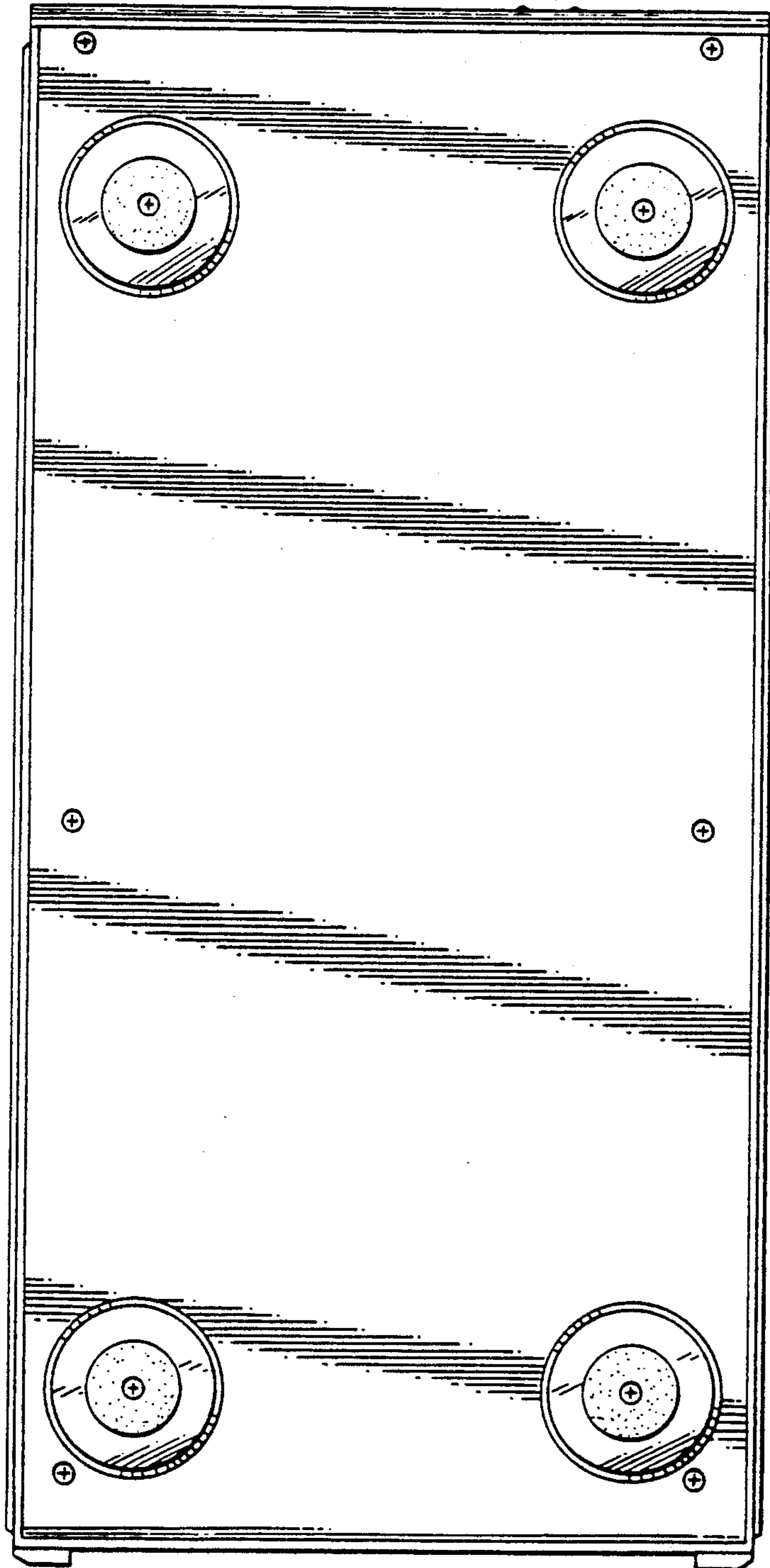

FIG. 7

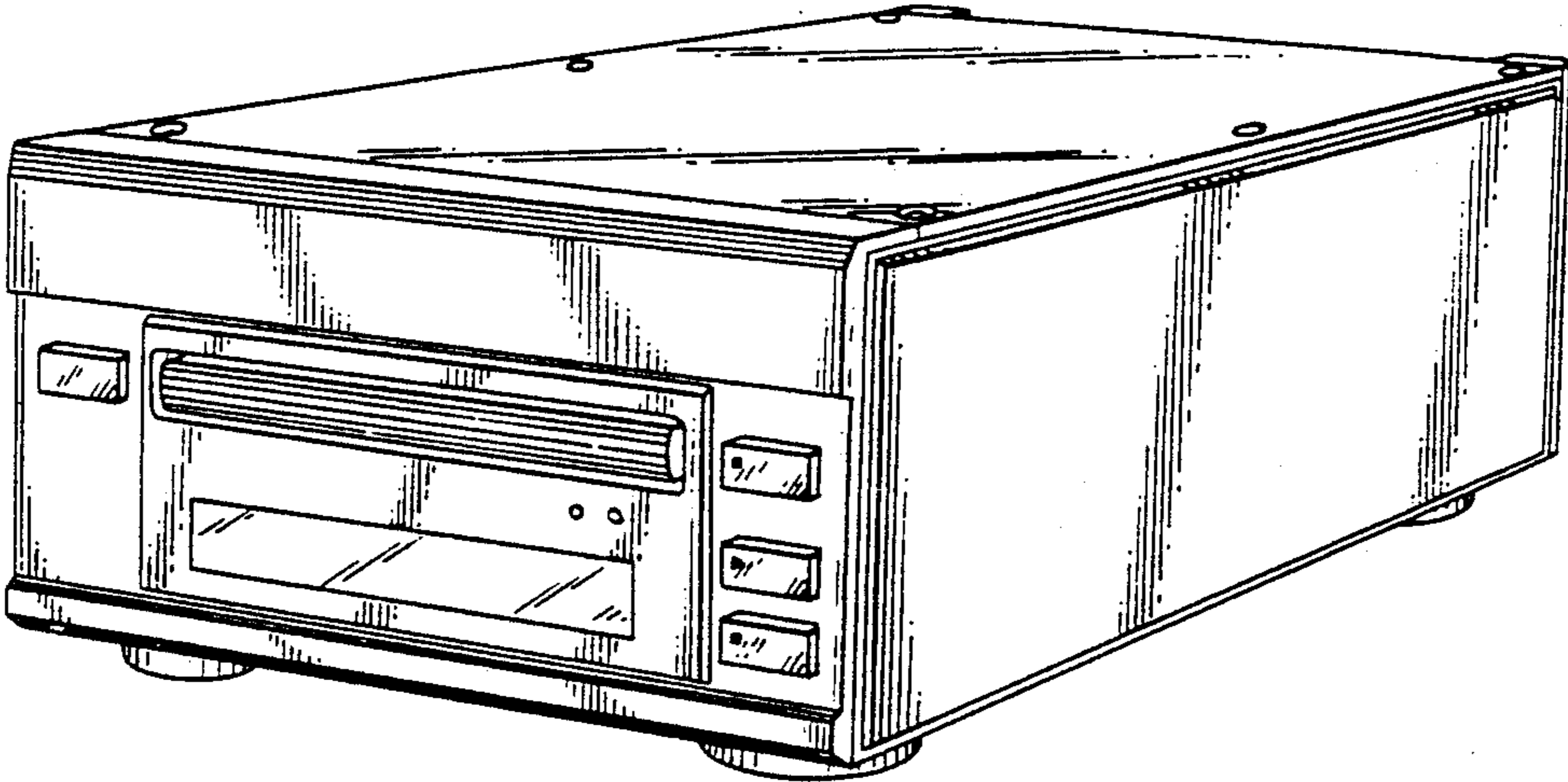

FIG. 8

