

[54] CRADLE FOR A PORTABLE TELEPHONE SET

[75] Inventors: Michio Nagai; Kozo Maemura, both of Tokyo, Japan

[73] Assignee: NEC Corporation, Tokyo, Japan

[**] Term: 14 Years

[21] Appl. No.: 546,058

[22] Filed: Jun. 29, 1990

[30] Foreign Application Priority Data

Dec. 29, 1989 [JP] Japan 1-48304

[52] U.S. Cl. D14/251; D14/253; D14/240; D14/138

[58] Field of Search D14/251, 253, 138, 240; 379/440, 455, 454, 428; 455/89, 90

[56] References Cited

U.S. PATENT DOCUMENTS

- D. 158,060 4/1950 Flatter et al. D14/253
- D. 216,427 1/1970 Dreyfuss et al. D14/142
- D. 253,703 12/1979 Hillman et al. D14/151
- D. 256,234 8/1980 Fukushima et al. D14/138
- D. 261,509 10/1981 Cobb D14/253
- D. 266,506 10/1982 Fakushima et al. D14/138
- D. 271,391 11/1983 Schaid D13/107
- D. 275,482 9/1984 Coons et al. D14/253

- D. 283,509 4/1986 Shebayama et al. D14/138 X
- D. 285,070 8/1986 Beaumont D14/253
- D. 294,496 3/1988 Drakalovic et al. D14/138
- D. 294,827 3/1988 Woodfork D14/138
- D. 298,829 12/1988 Watanabe D14/138
- D. 301,474 6/1989 Matsumi et al. D14/142
- D. 305,652 1/1990 Tejima D14/142 X
- D. 306,594 3/1990 Taylor D14/253
- D. 309,451 7/1990 Nagele D14/138 X
- D. 315,161 3/1991 Watanabe D14/138 X
- 4,782,526 11/1988 Uchino et al. 379/419
- 4,797,916 1/1989 Kojima 379/445 X

Primary Examiner—Horace B. Fay, Jr.
Attorney, Agent, or Firm—Sughrue, Mion, Zinn, Macpeak & Seas

[57] CLAIM

The ornamental design for a cradle for a portable telephone set, as shown and described.

DESCRIPTION

FIG. 1 is a front elevational view of a cradle for a portable telephone set showing our new design; FIG. 2 is a rear elevational view thereof; FIG. 3 is a top plan view thereof; FIG. 4 is a bottom plan view thereof; FIG. 5 is a right side elevational view thereof, the left side being a mirror image thereof; and FIG. 6 is a front, top and right side perspective view thereof.

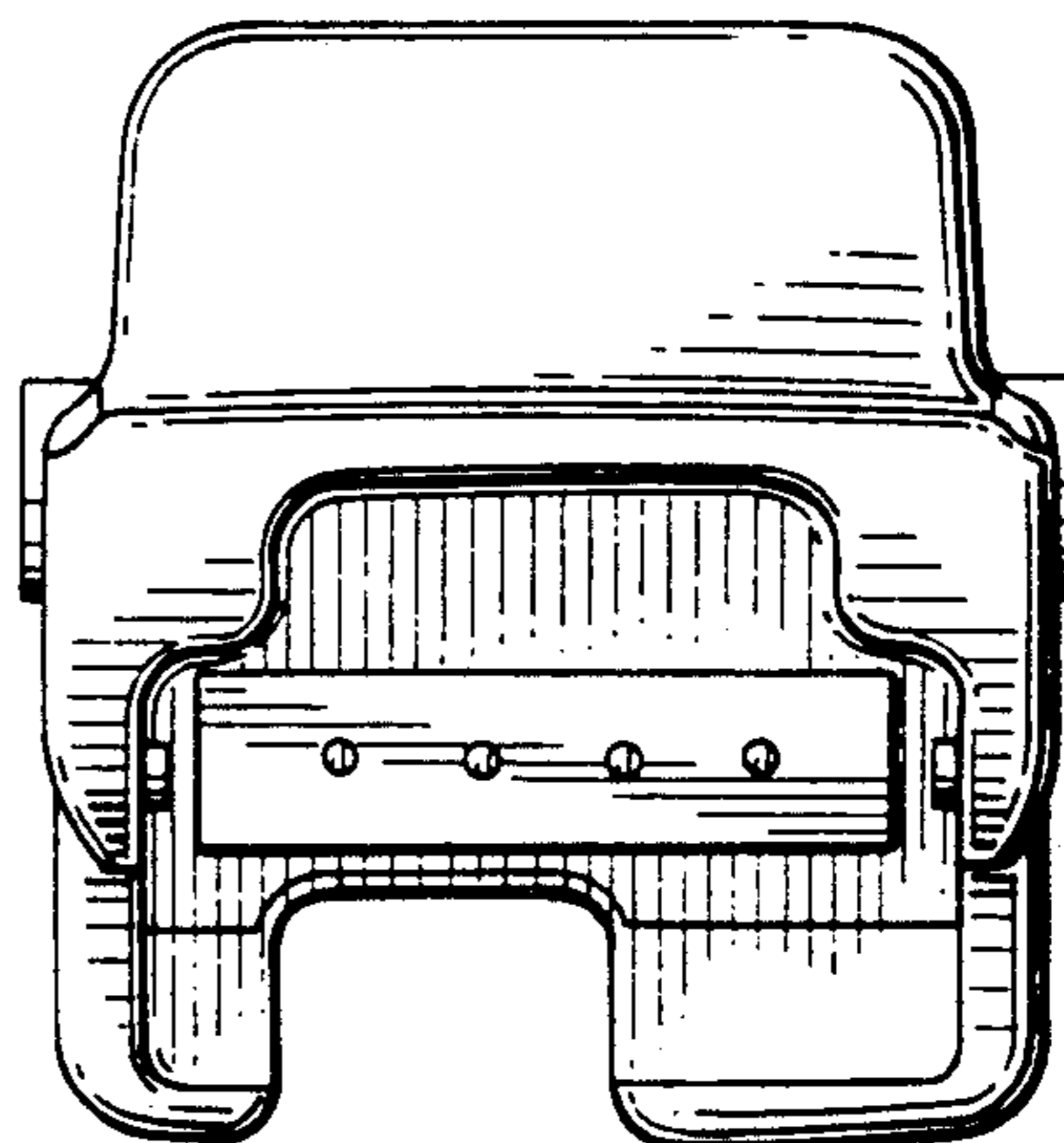
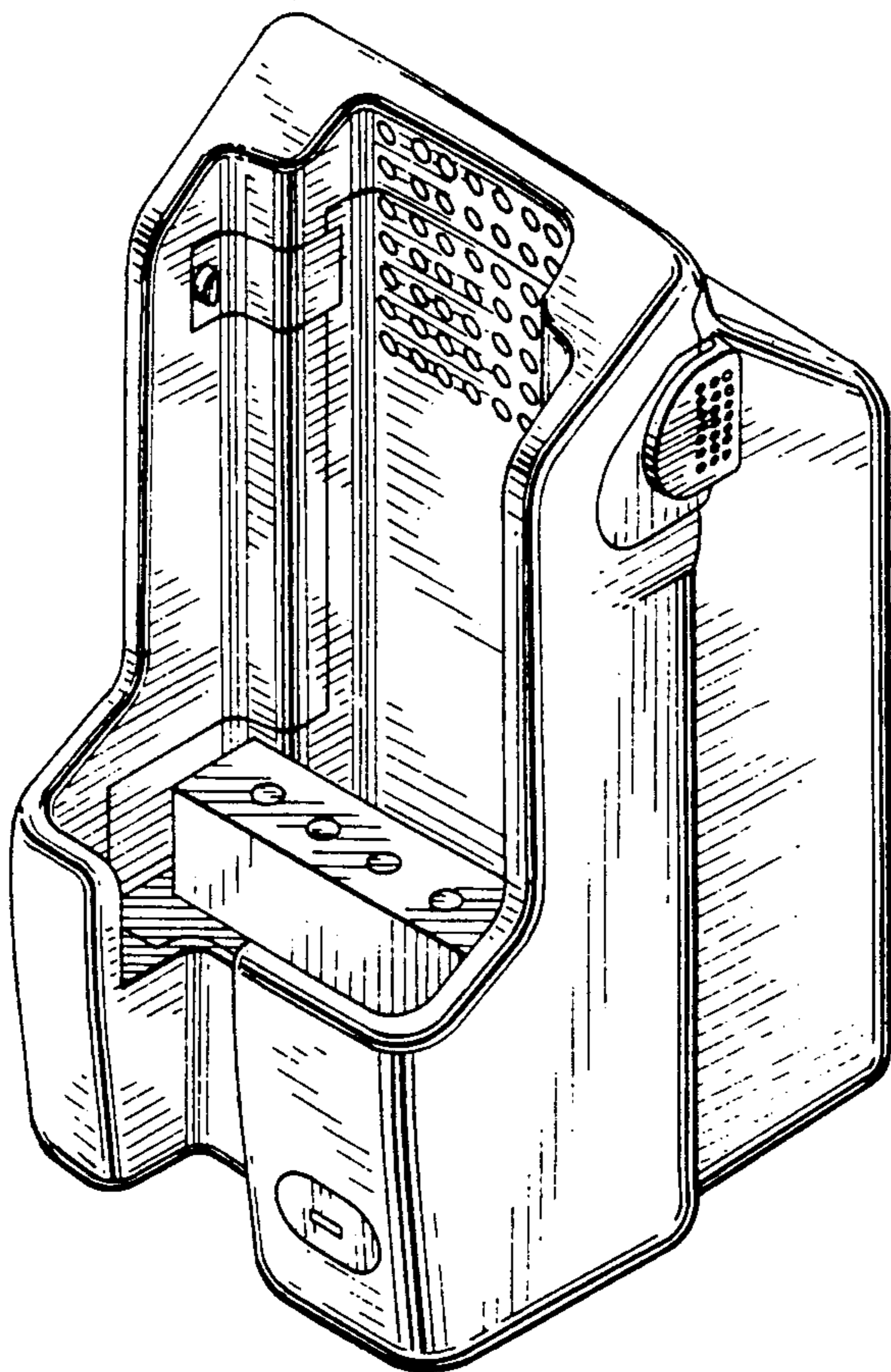

FIG. 1

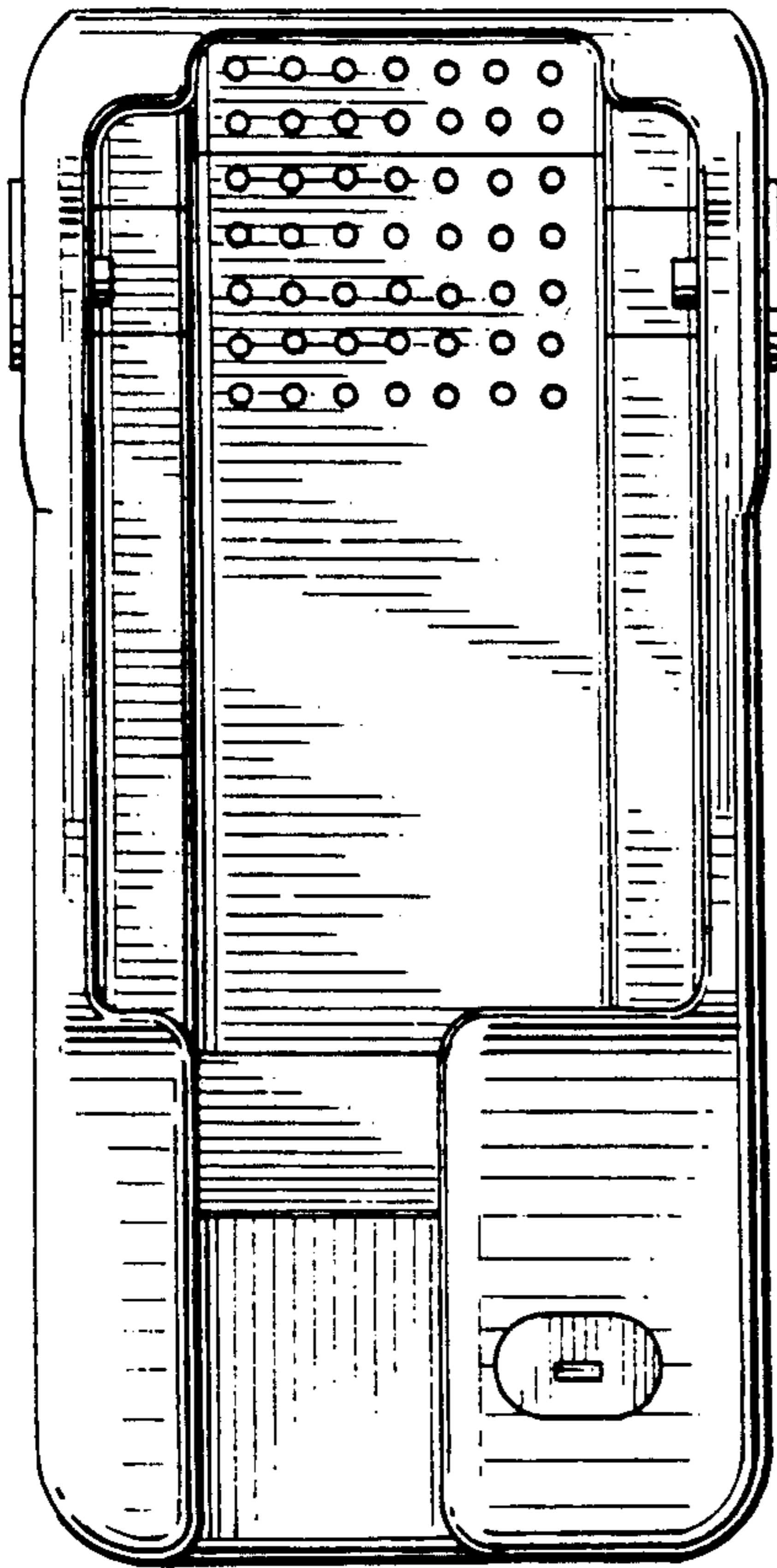

FIG. 2

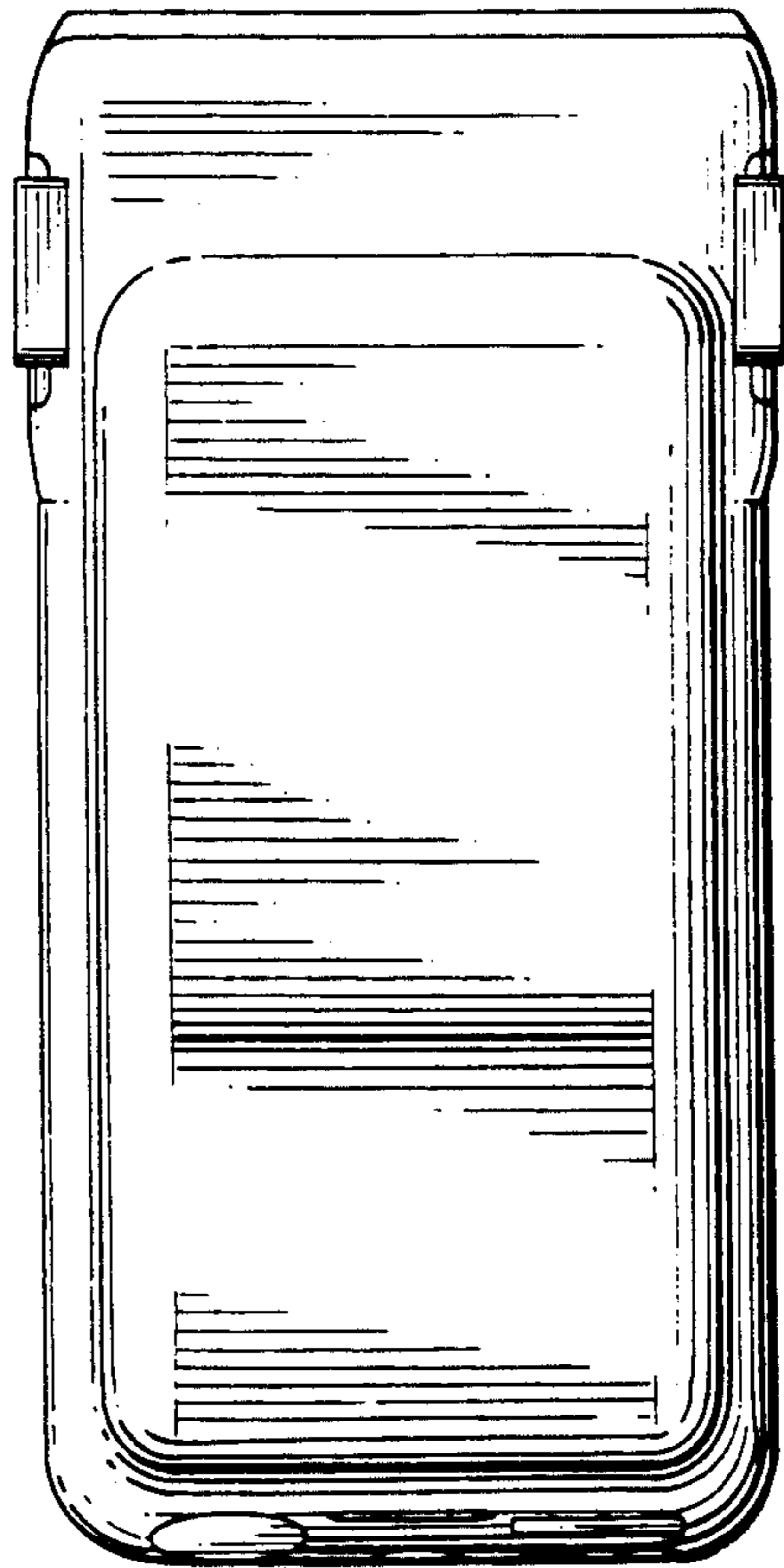

FIG. 3

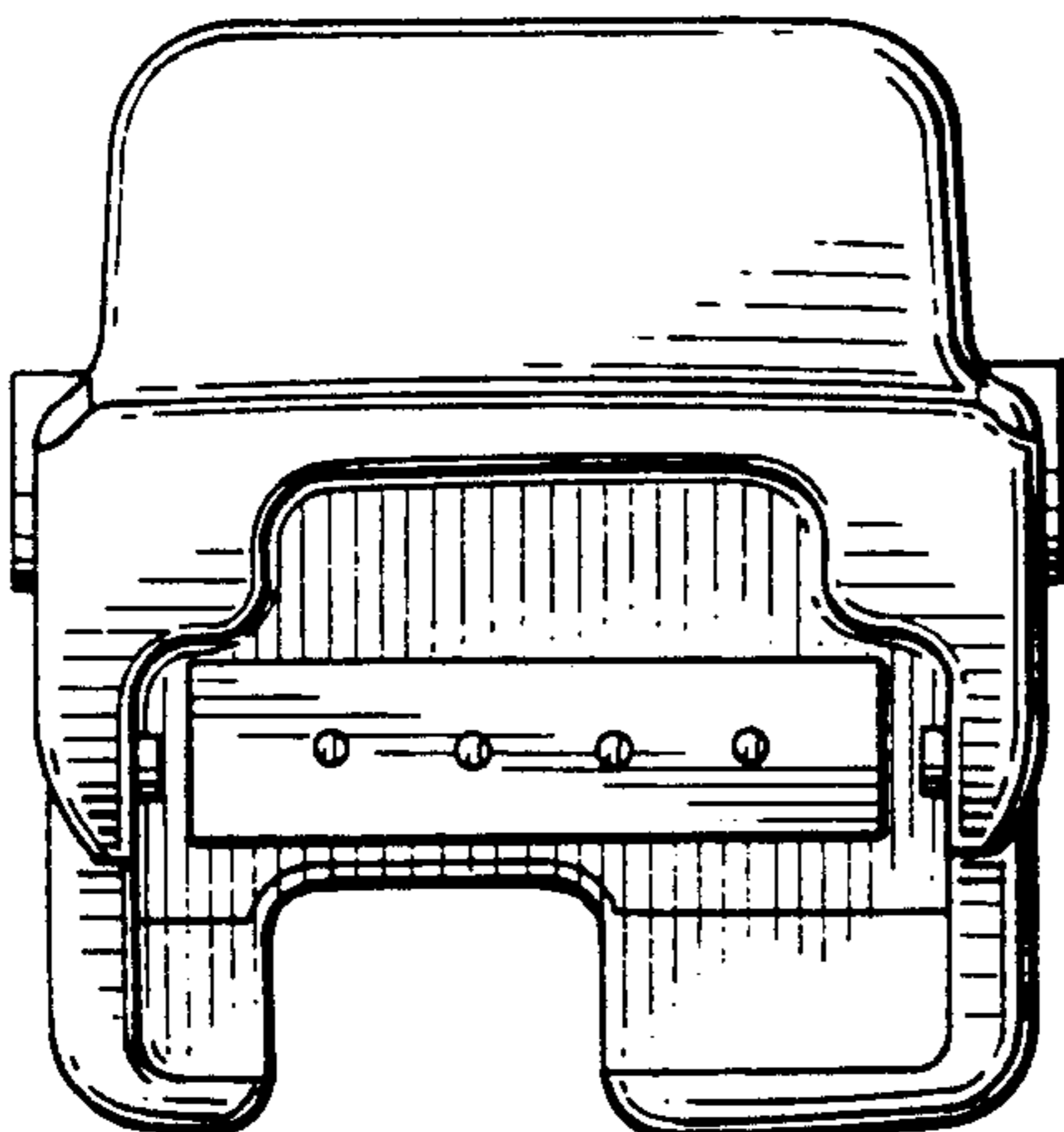
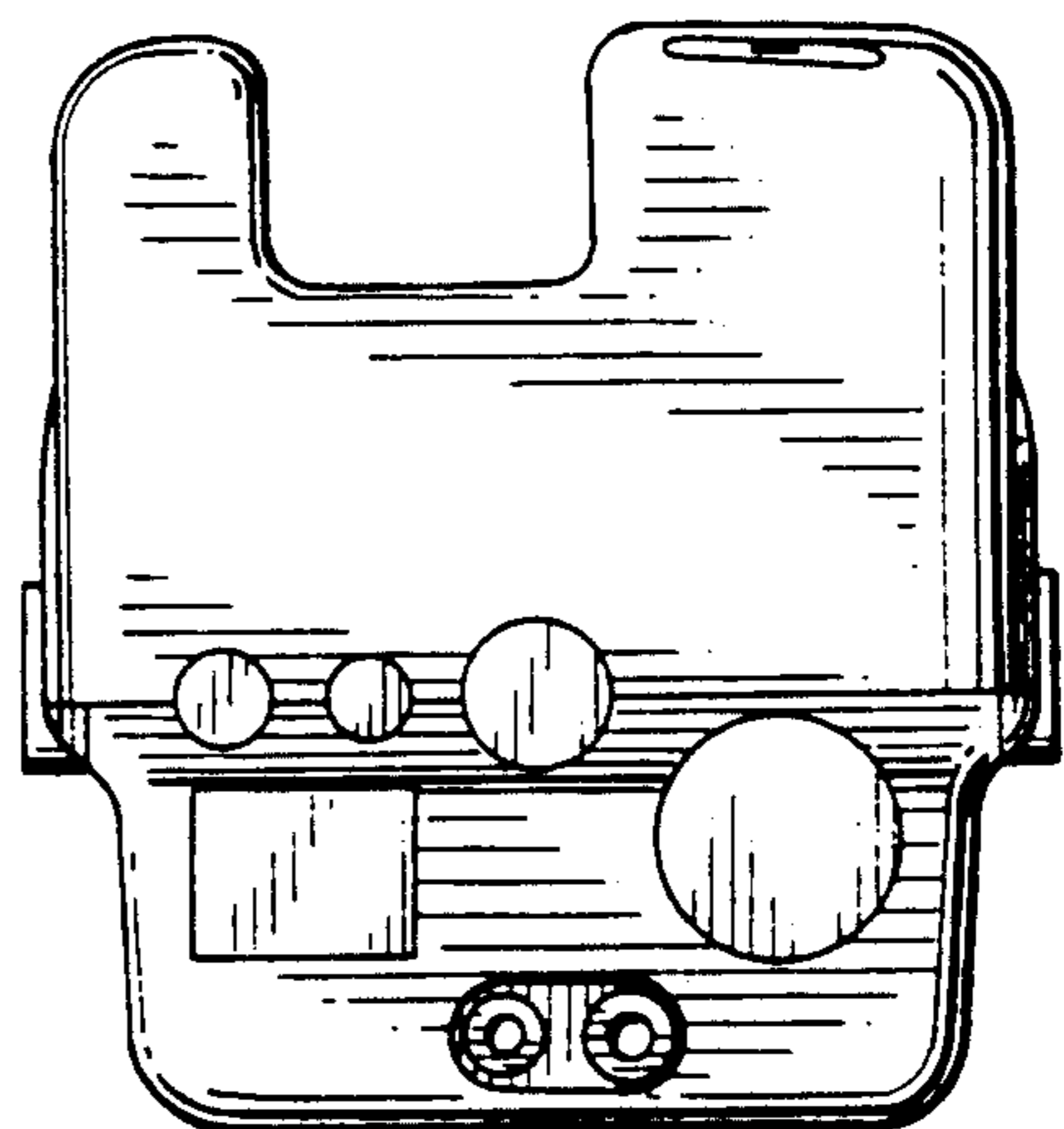

FIG. 4



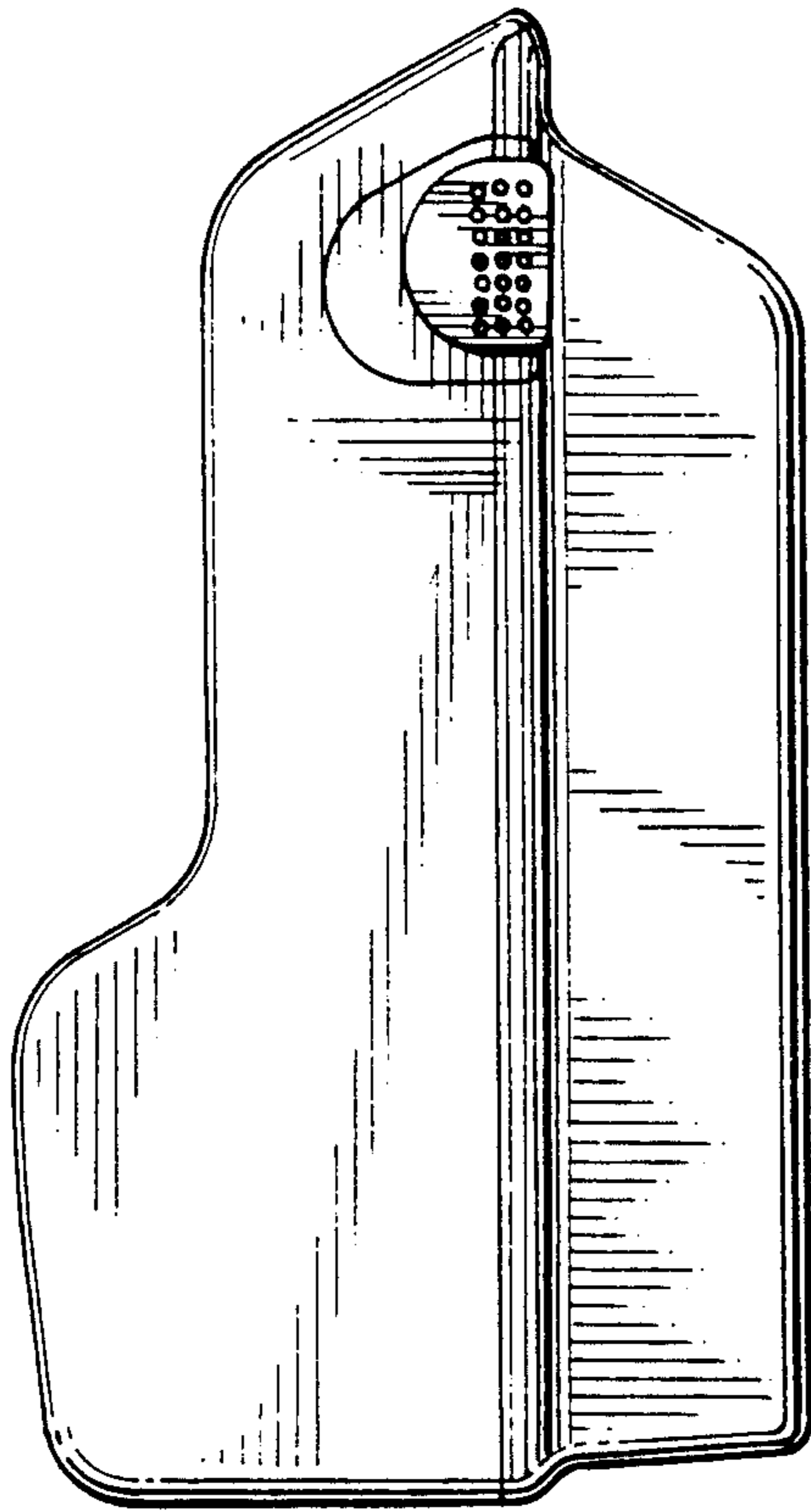

FIG. 5

FIG. 6

