

[54] HEADGEAR FOR FACESHIELD

[75] Inventors: Gary D. Asbury, Kansas City, Kans.;
John W. Lewman, Kansas City, Mo.

[73] Assignee: Parmelee Industries, Inc., Kansas
City, Mo.

[**] Term: 14 Years

[21] Appl. No.: 400,038

[22] Filed: Aug. 29, 1989

[52] U.S. Cl. D29/16; D29/6

[58] Field of Search D29/6, 9, 10, 15, 16,
D29/17, 99, 8; 2/411, 425, 8; 128/143, 206.24

3,763,495 10/1973 DeAngelis 2/8
4,736,469 4/1988 Boretti D29/17

Primary Examiner—Kay H. Chin
Attorney, Agent, or Firm—Hovey, Williams, Timmons &
Collins

[57] CLAIM

The ornamental design for a headgear for faceshield, as shown and described.

DESCRIPTION

FIG. 1 is a top and right side perspective view of a headgear for faceshield showing our new design; FIG. 2 is a right side elevational view thereof, the broken lines are for illustrative purposes only; FIG. 3 is a top plan view thereof; FIG. 4 is a bottom plan view thereof; FIG. 5 is a front elevation view thereof; and FIG. 6 is a rear elevation view thereof.

[56] References Cited

U.S. PATENT DOCUMENTS

2,755,476 7/1956 Bowers, Sr. 2/8

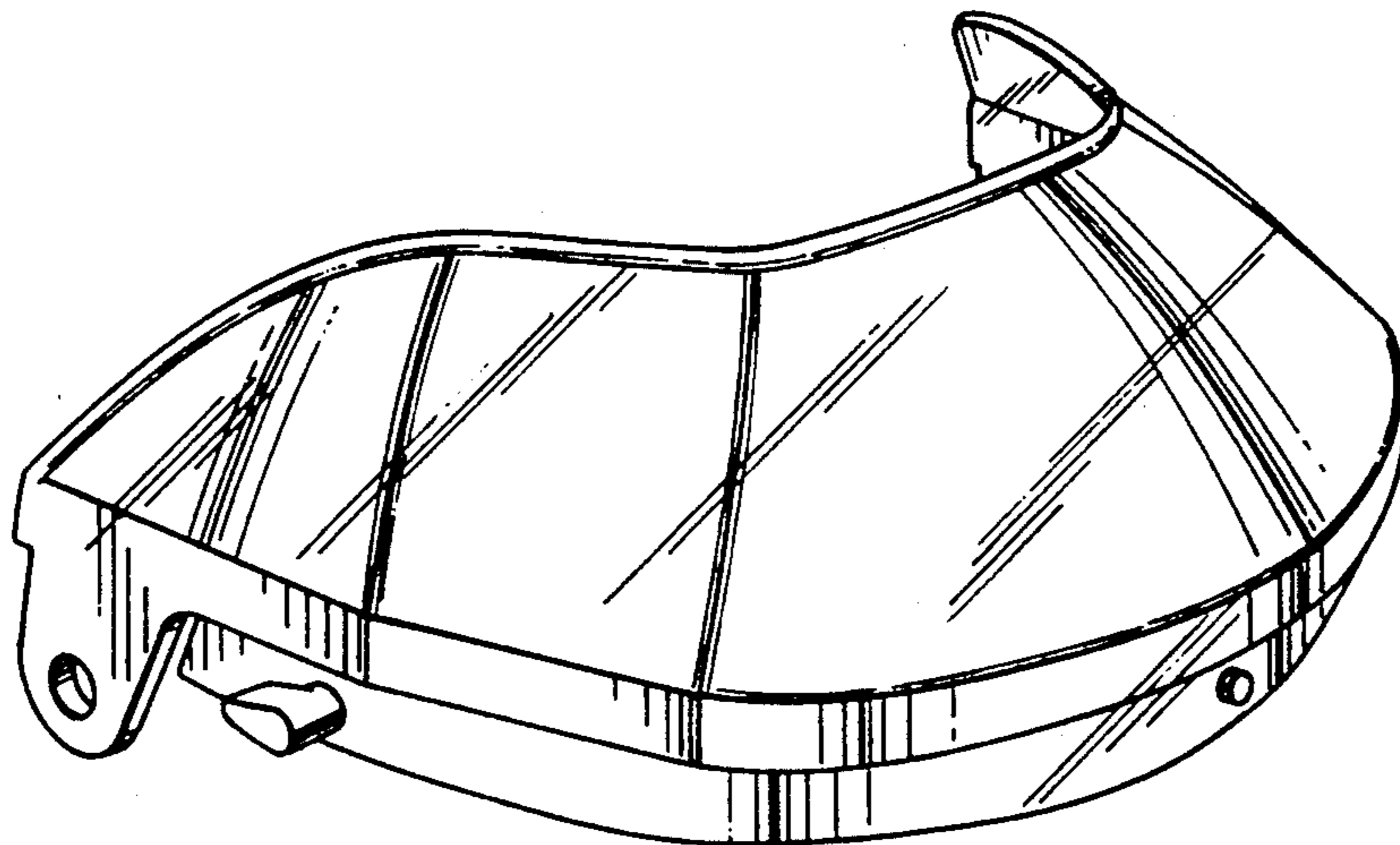

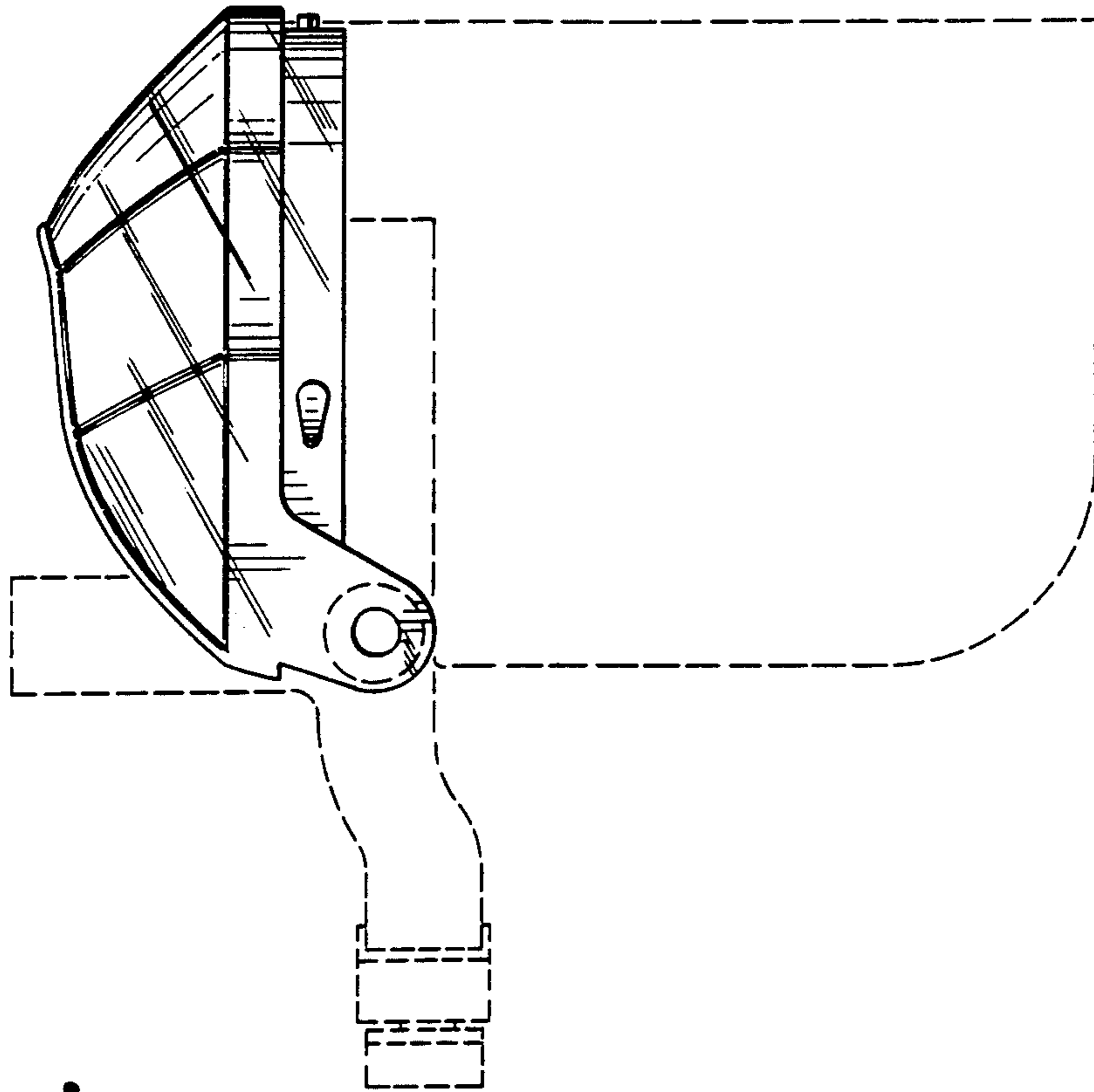

Fig. 1.

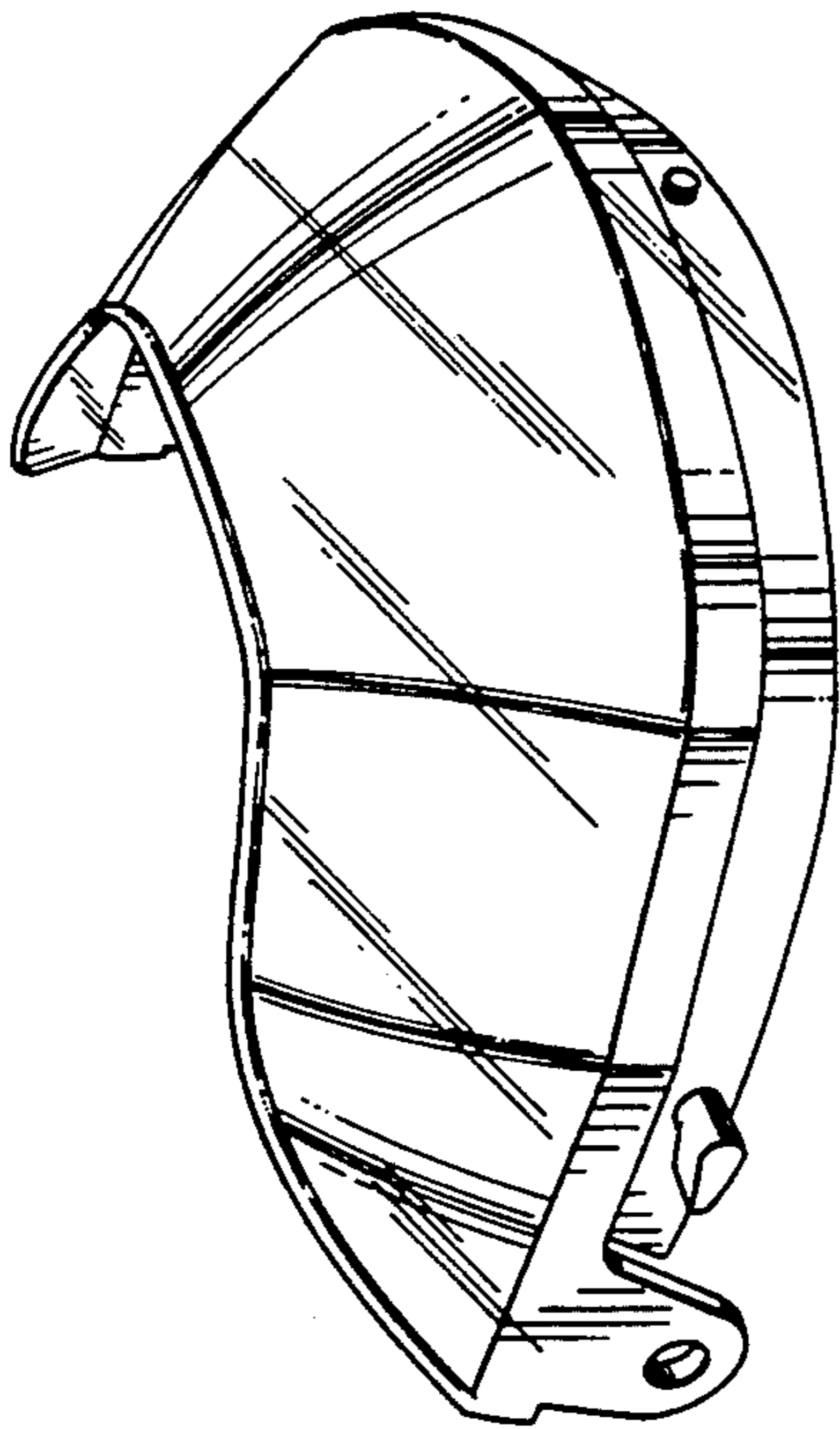

Fig. 2.

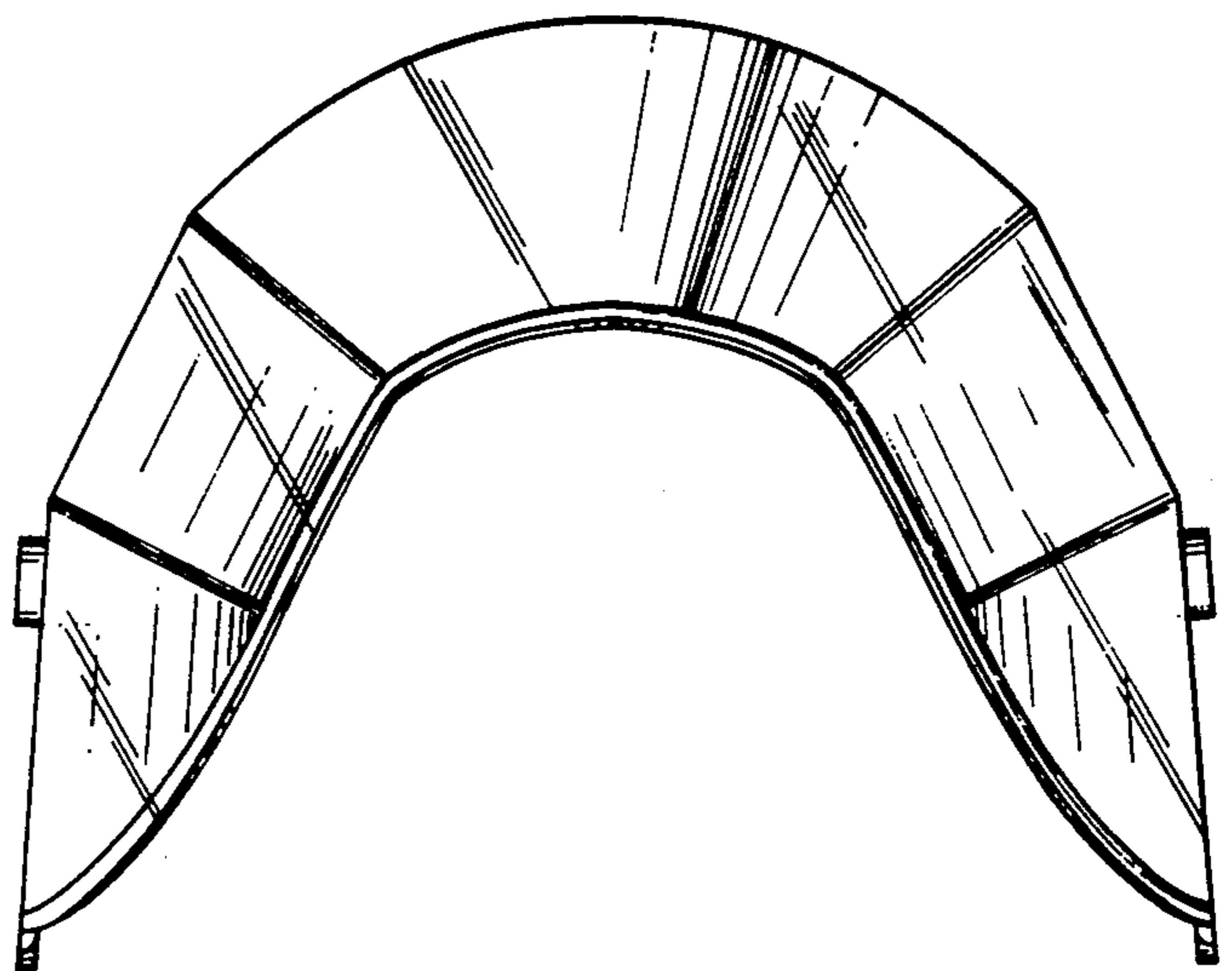

Fig. 3.

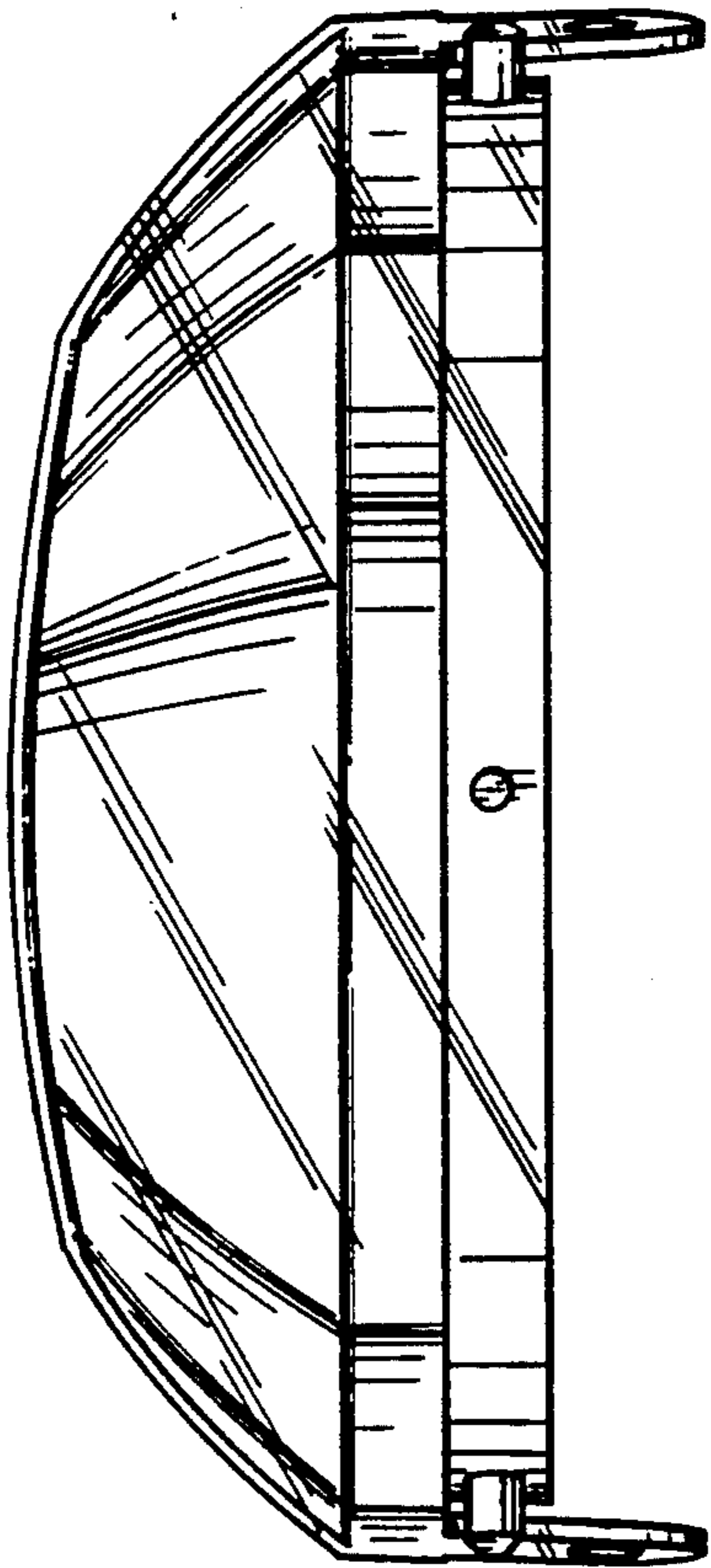

Fig. 5.

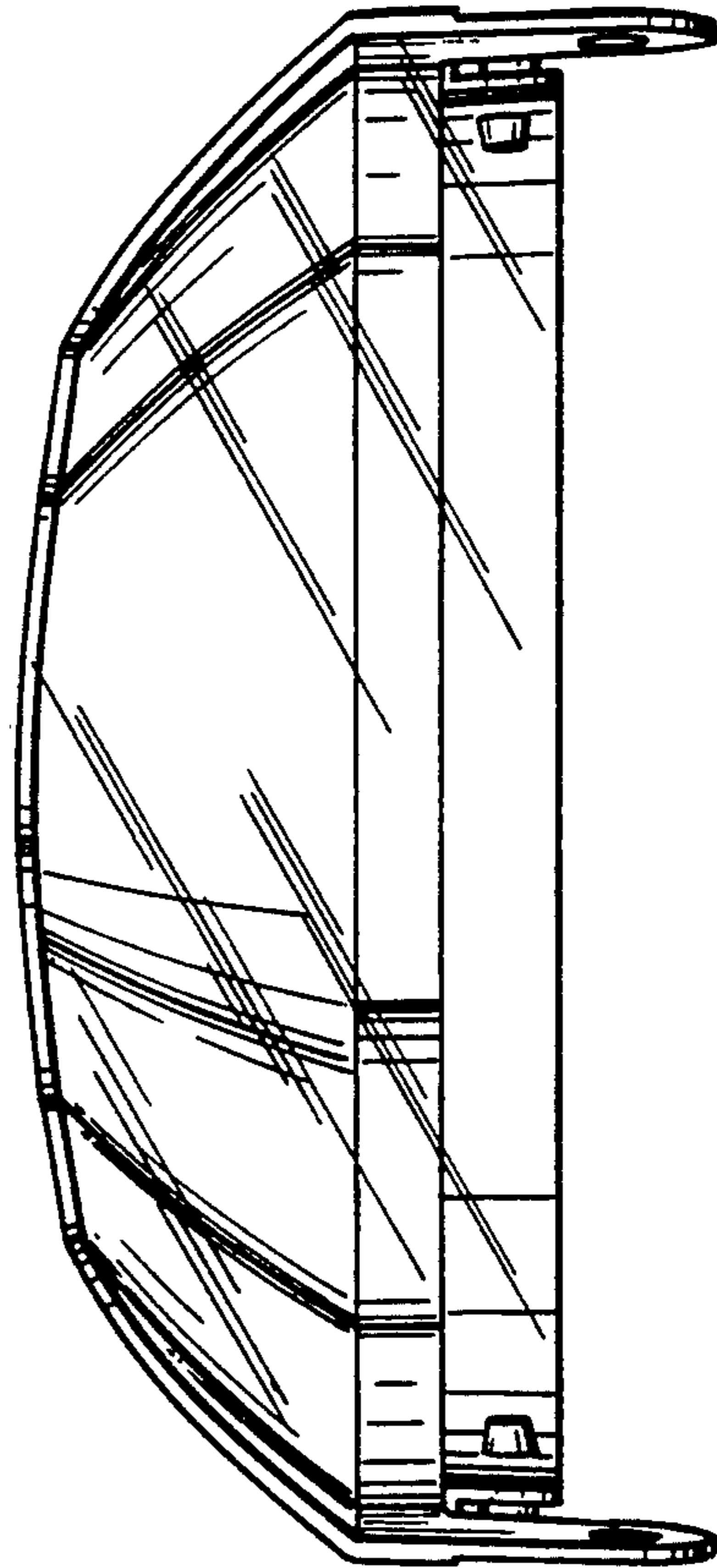

Fig. 6.

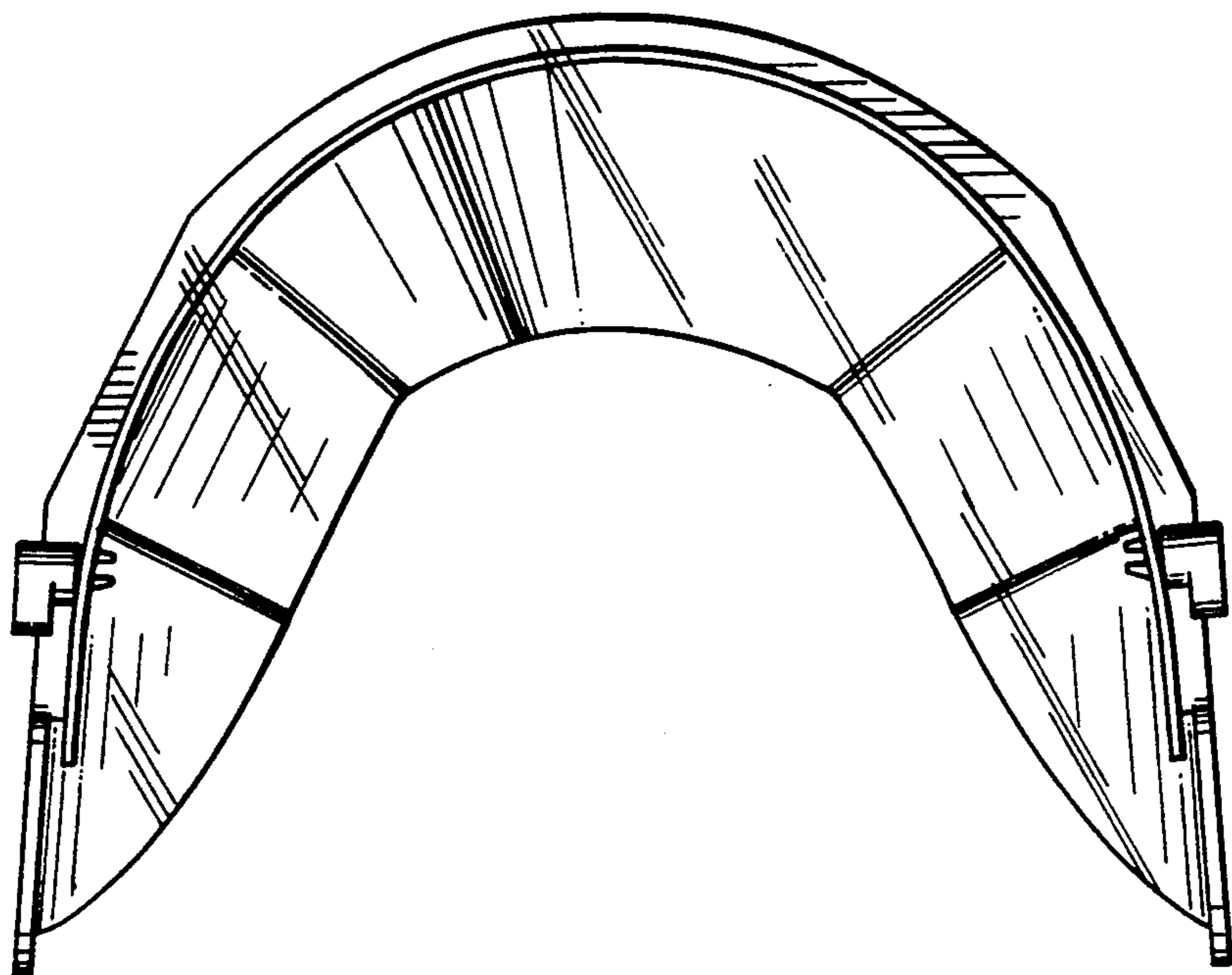

Fig. 4.