

[54] AGRICULTURAL BAG FILLING MACHINE

4,653,553 3/1987 Cox et al. .... 141/71  
4,819,701 4/1989 Thorton ..... 141/231

[75] Inventors: William C. Johnson, Omaha, Nebr.;  
Mervin E. Aurand, Adrian, Mo.

Primary Examiner—Bernard Ansher  
Assistant Examiner—Sandra Morris  
Attorney, Agent, or Firm—Laney, Dougherty, Hessin &  
Beavers

[73] Assignee: Rand Farm Systems, Inc., Adrian,  
Mo.

[\*\*] Term: 14 Years

[57] CLAIM

[21] Appl. No.: 248,565

The ornamental design for an agricultural bag filling  
machine, as shown and described.

[22] Filed: Sep. 26, 1988

[52] U.S. Cl. .... D15/27

DESCRIPTION

[58] Field of Search ..... D15/10, 27; 56/341;  
141/71, 114, 231, 314

FIG. 1 is a right side elevational view of an agricultural  
bag filling machine showing our new design;  
FIG. 2 is a top plan view thereof;  
FIG. 3 is a left side elevational view thereof;  
FIG. 4 is a bottom plan view thereof;  
FIG. 5 is a front elevational view thereof;  
FIG. 6 is a rear elevational view thereof;  
FIG. 7 is a perspective view thereof.

[56] References Cited

U.S. PATENT DOCUMENTS

4,308,901 1/1982 Lee ..... 141/114  
4,412,567 11/1983 Kosters ..... 141/114  
4,594,836 7/1986 Good ..... 141/114

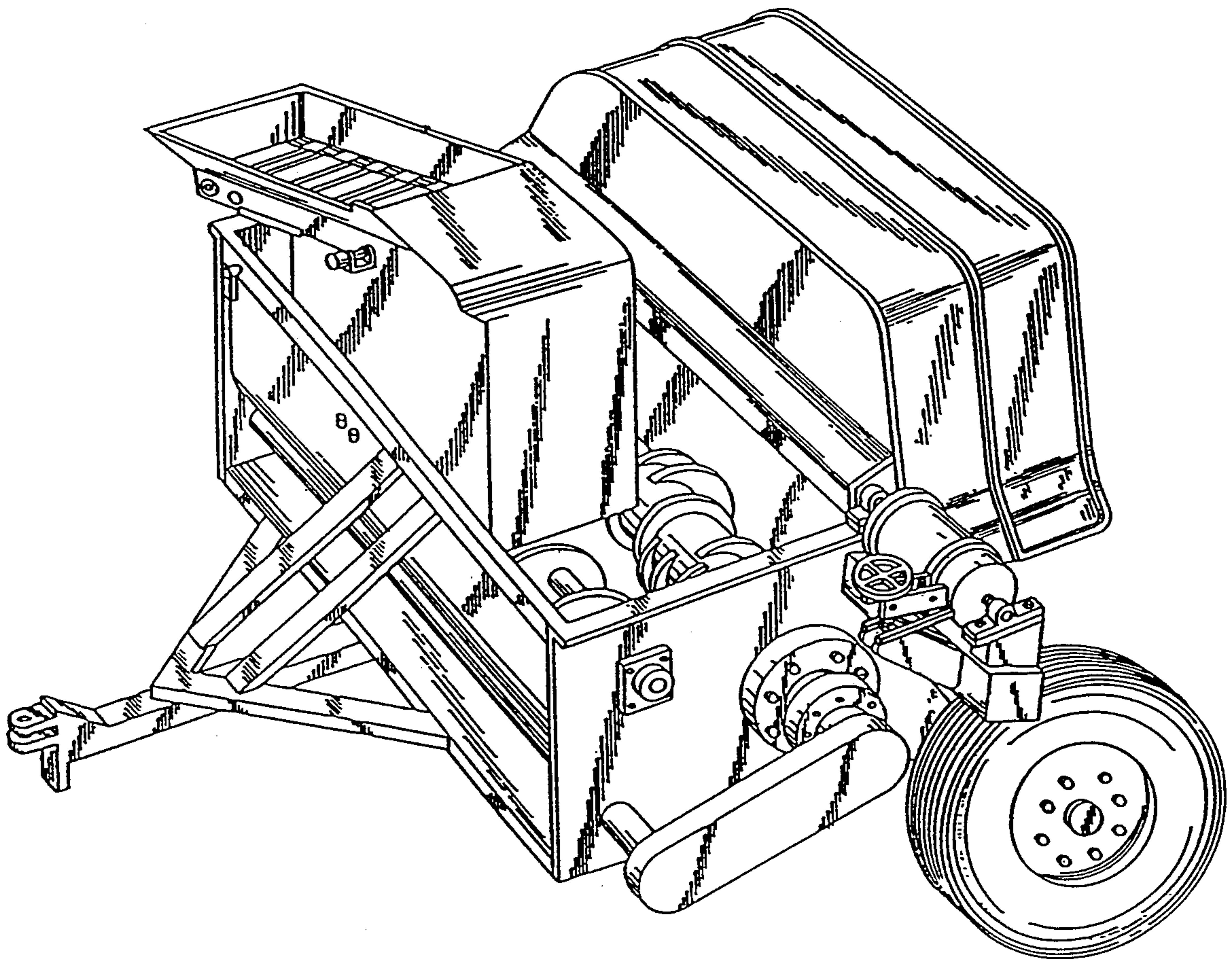

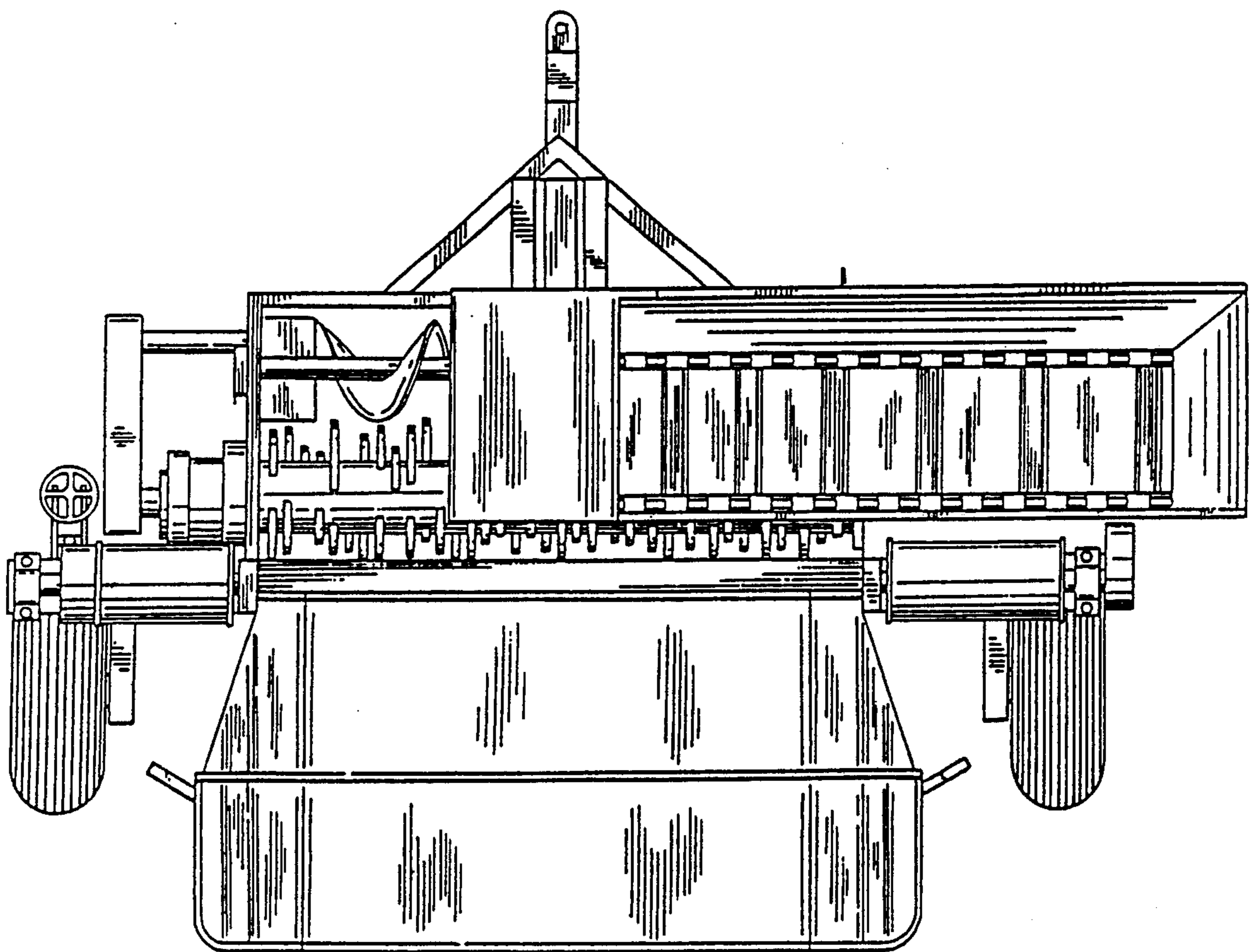
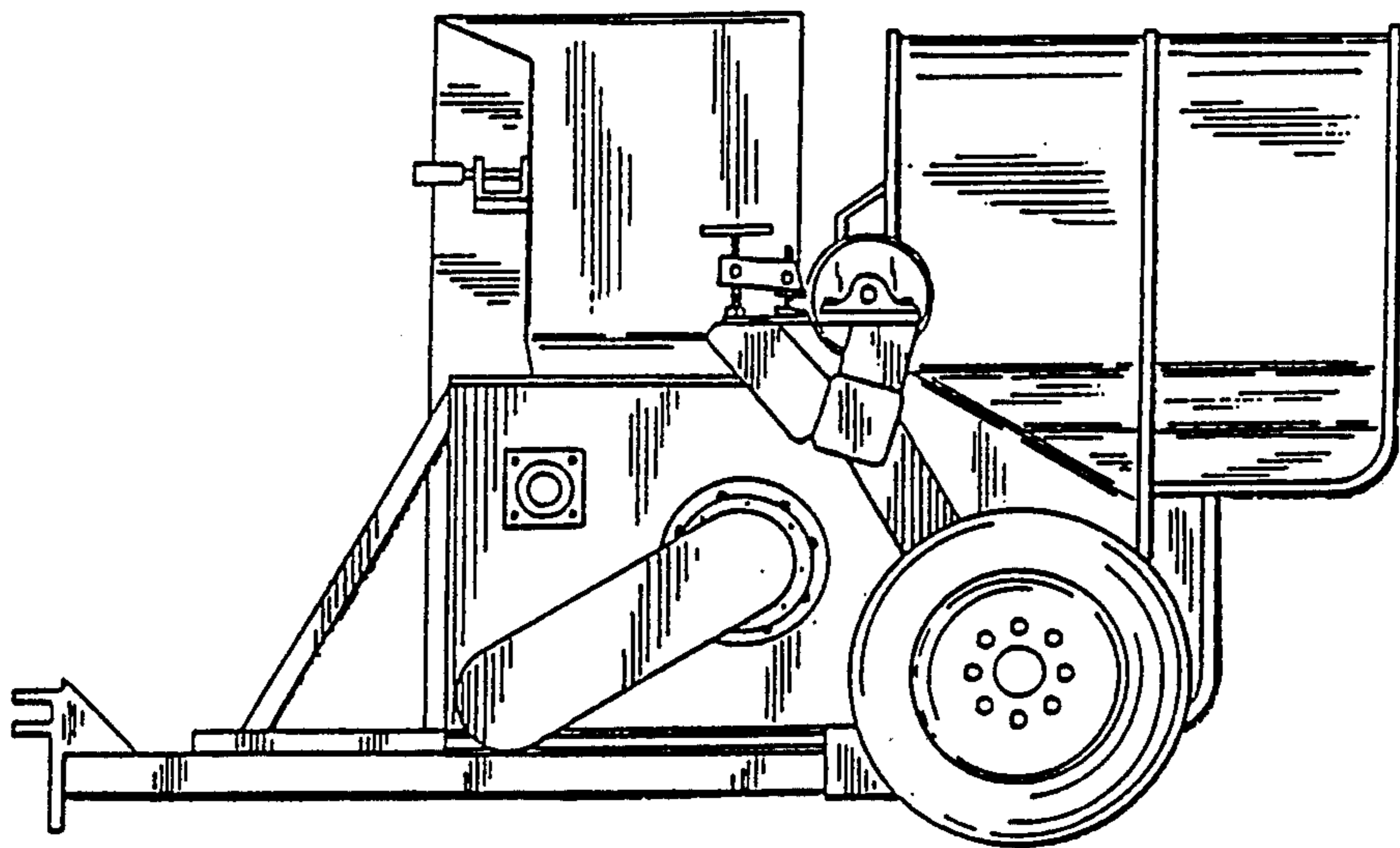

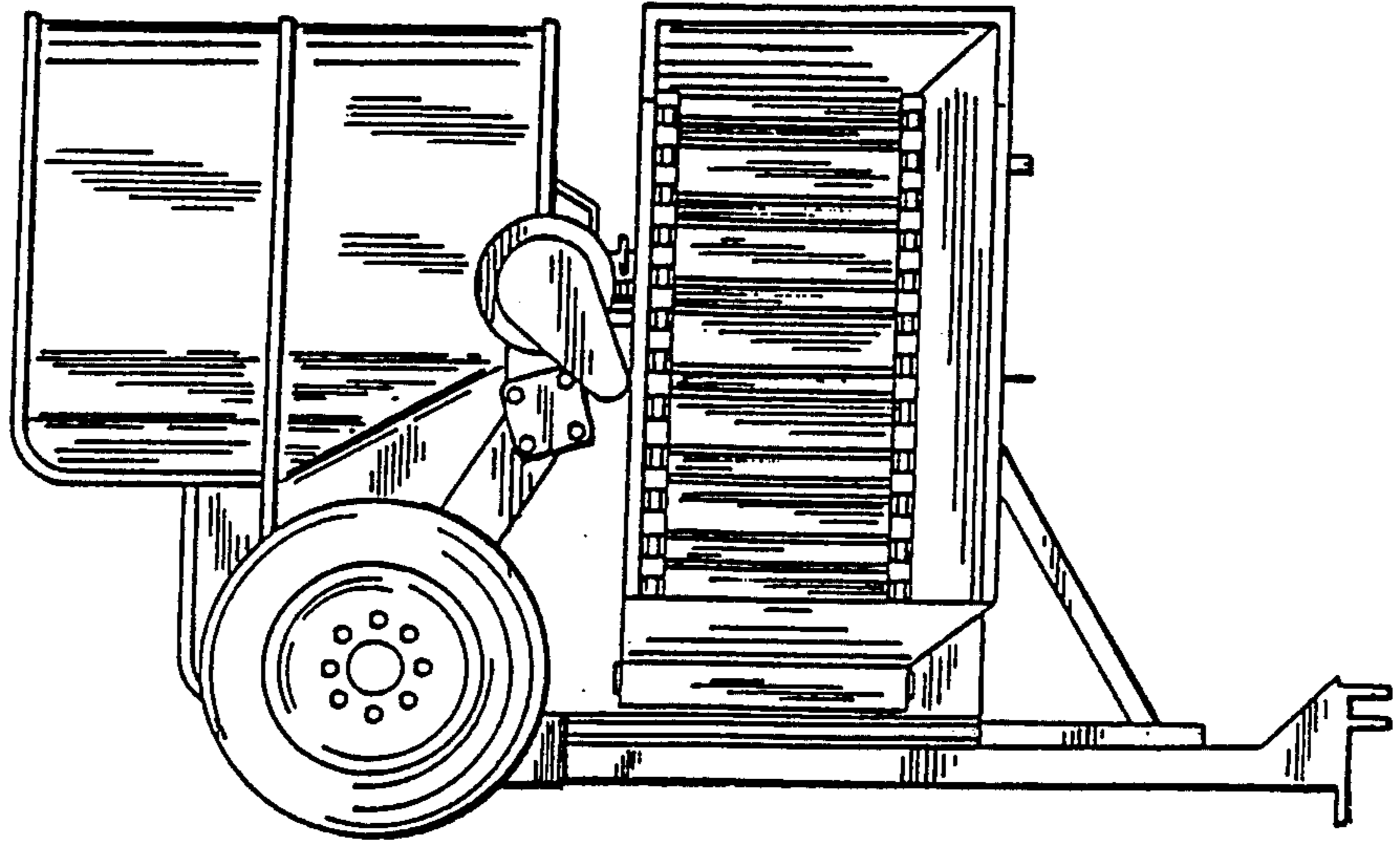

FIG. 3

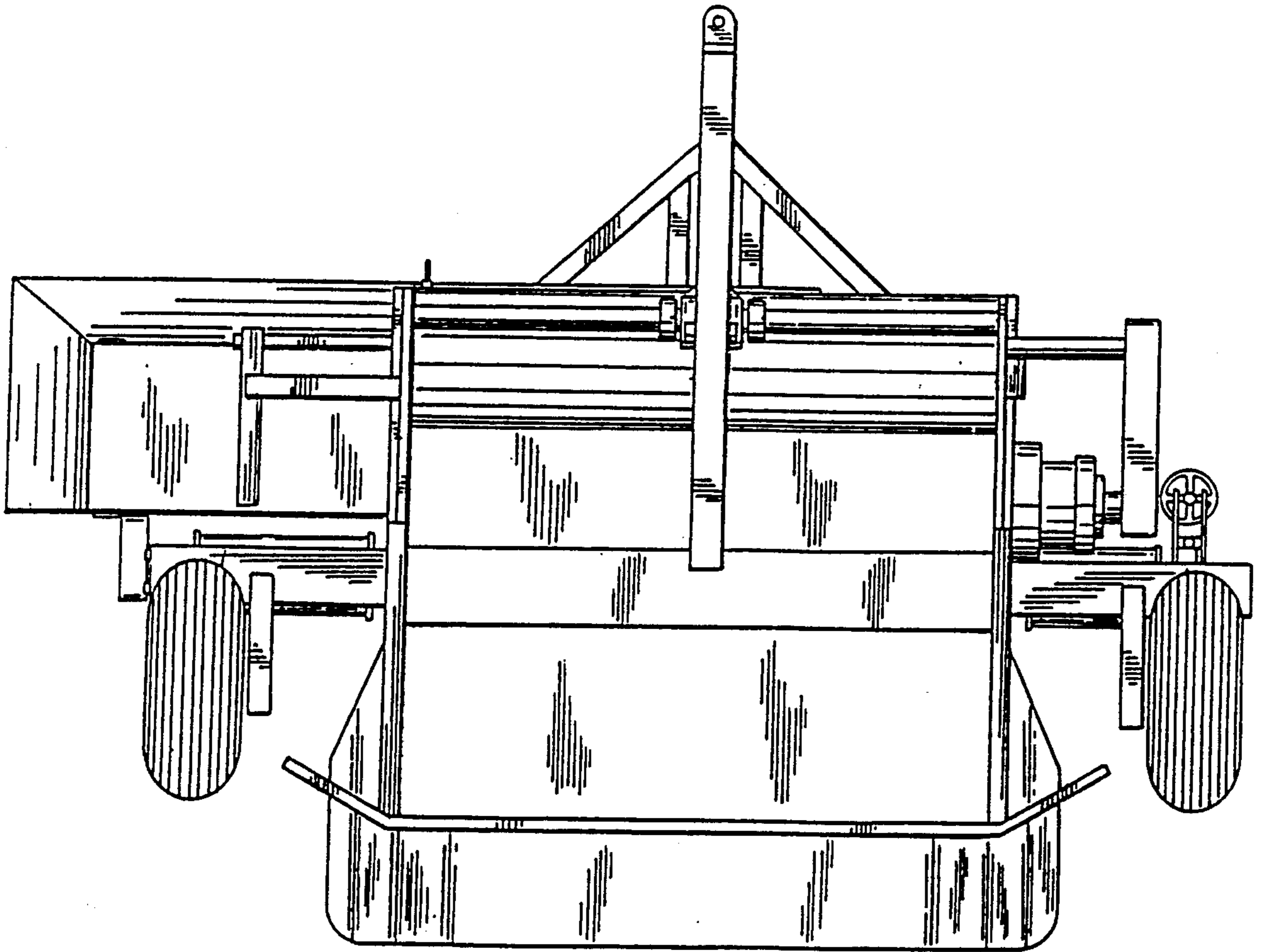

FIG. 4

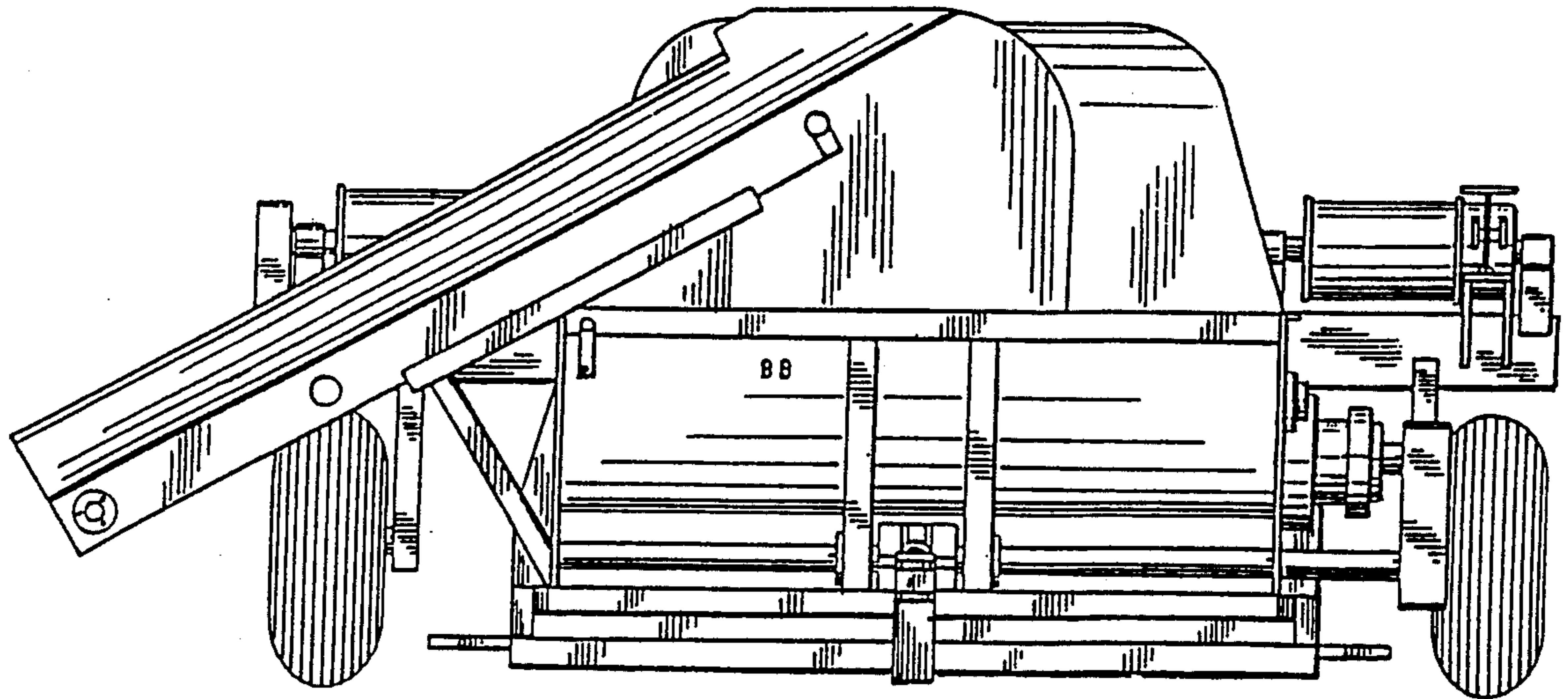

FIG. 5

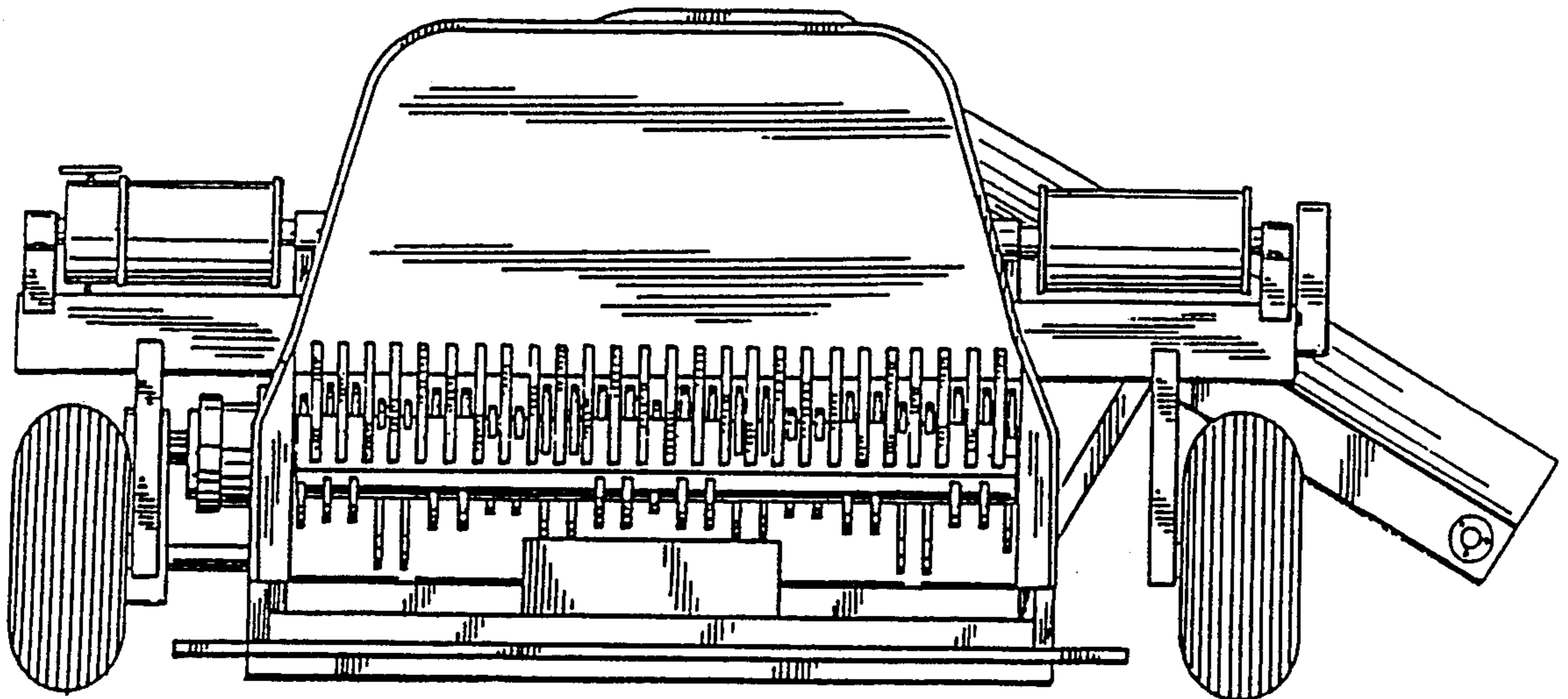

FIG. 6

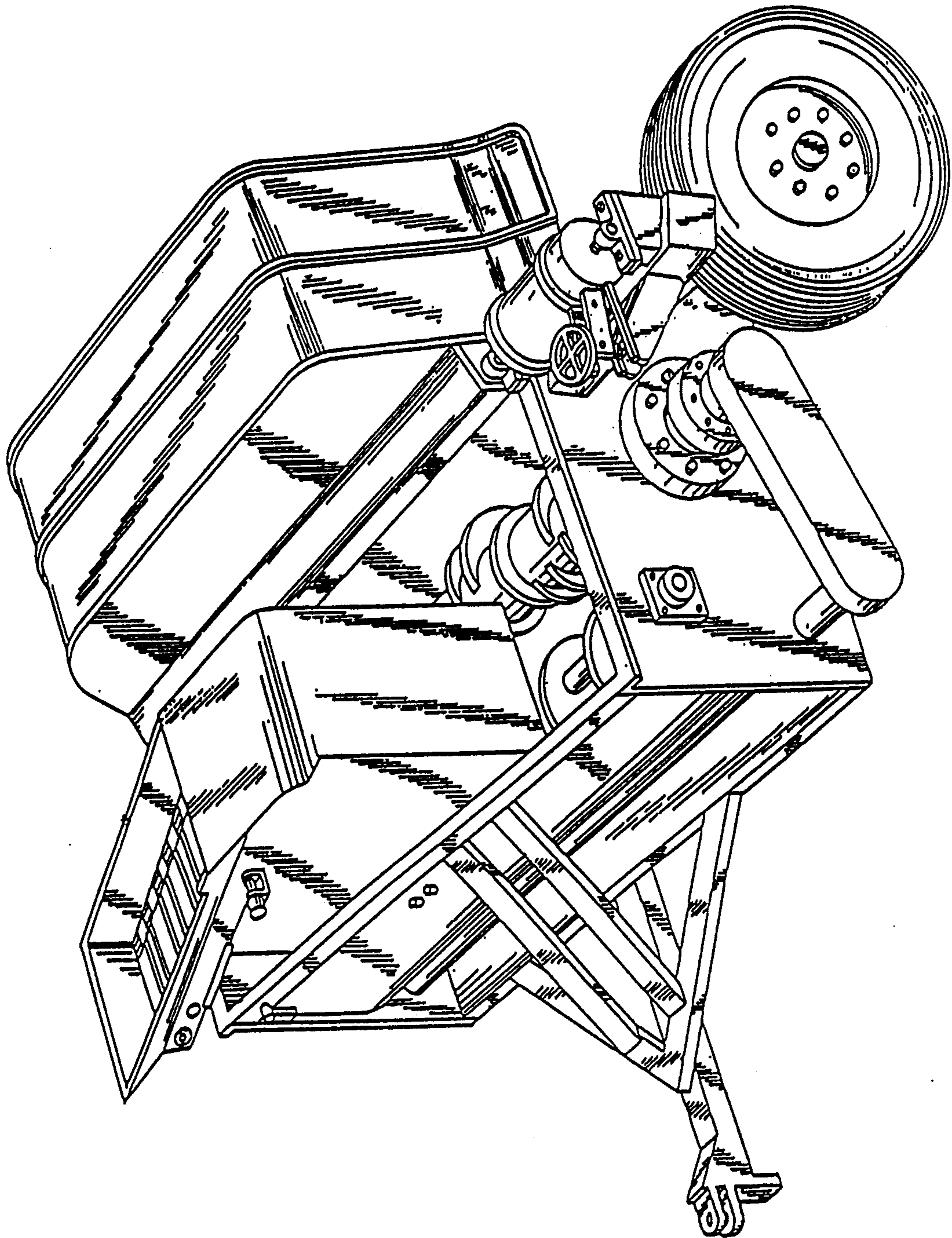

FIG. 1