

[54] TEACUP OR SIMILAR ARTICLE

[75] Inventor: Steve A. Unger, Manilus, N.Y.

[73] Assignee: Syracuse China Corporation, Syracuse, N.Y.

[\*\*] Term: 14 Years

[21] Appl. No.: 321,552

[22] Filed: Mar. 10, 1989

[52] U.S. Cl. .... D7/536

[58] Field of Search ..... D7/509-514, D7/519-521, 523, 533-536, 531, 532, 396.4, 396.5, 584, 585

[56] References Cited

U.S. PATENT DOCUMENTS

- D. 100,852 8/1936 Cowan ..... D7/536
- D. 167,936 10/1952 Folley ..... D7/535
- D. 266,298 9/1982 Moskal ..... D7/521

OTHER PUBLICATIONS

*Jackson China*, ©1972 Postmarked 6-6-75, p. 7 "Swirl"-Handled and Unhandled Cups at top.

*Primary Examiner*—Winifred E. Herrmann  
*Attorney, Agent, or Firm*—Cushman, Darby & Cushman

[57] CLAIM

The ornamental design for the teacup or similar article, as shown and described.

DESCRIPTION

FIG. 1 is a side elevational view of a teacup or similar article showing my new design, the side opposite is a mirror image;

FIG. 2 is an end elevational view taken from the left side of FIG. 1;

FIG. 3 is an end elevational view taken from the right side of FIG. 1;

FIG. 4 is a top plan view thereof;

FIG. 5 is a bottom plan view thereof; and

FIG. 6 is a cross-sectional view thereof taken along lines 6—6 of FIG. 4.

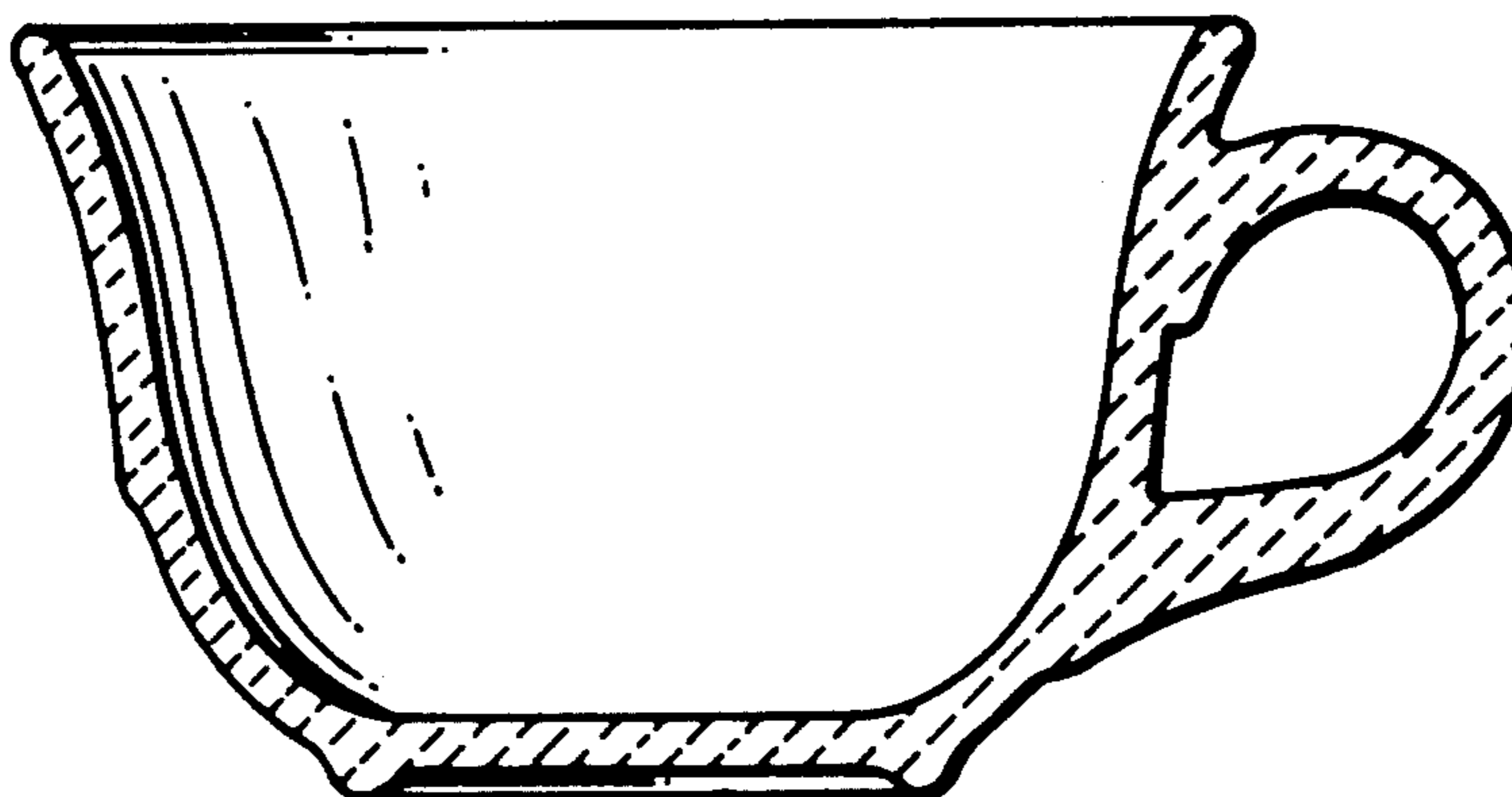
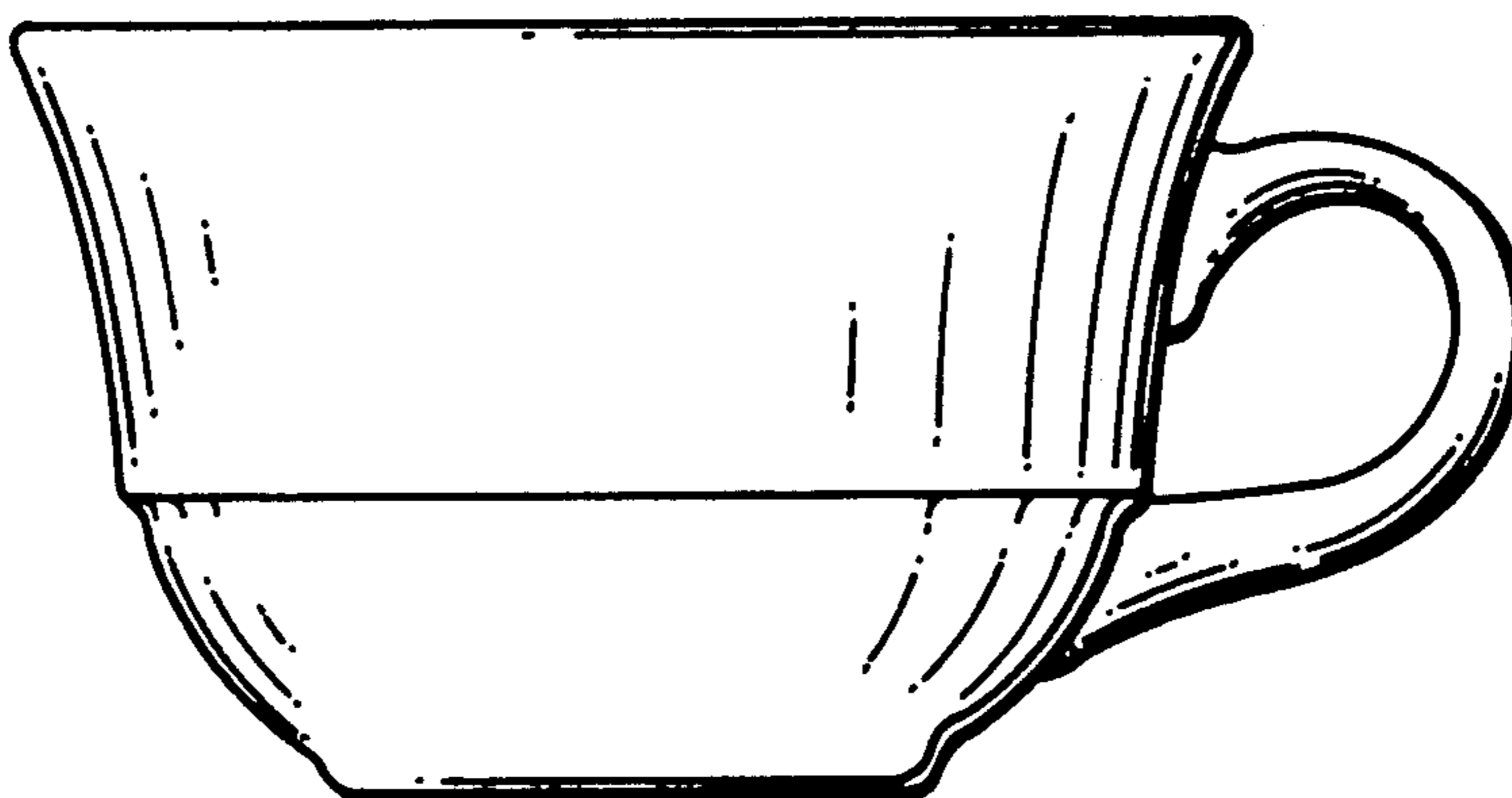

FIG. 2

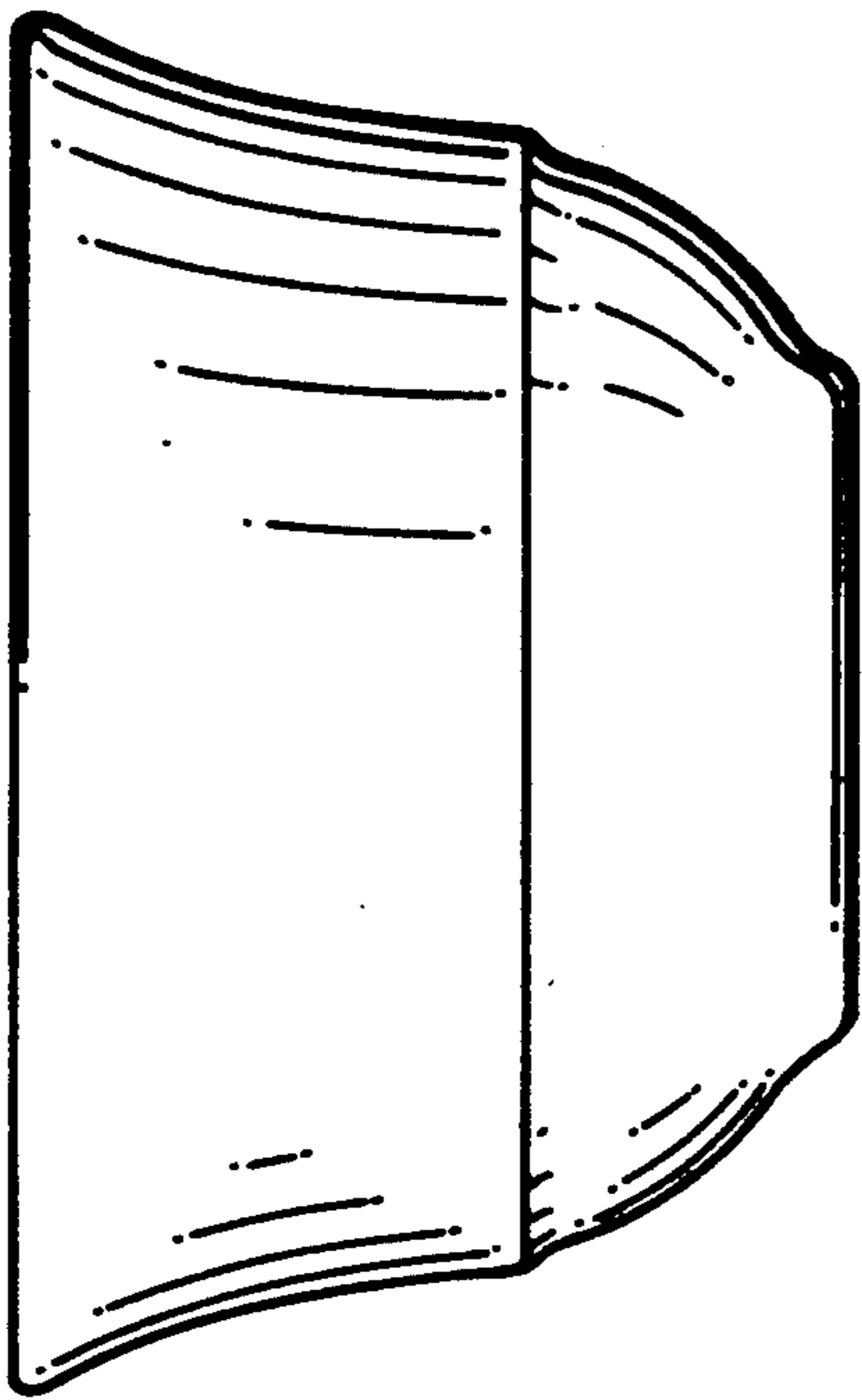

FIG. 3

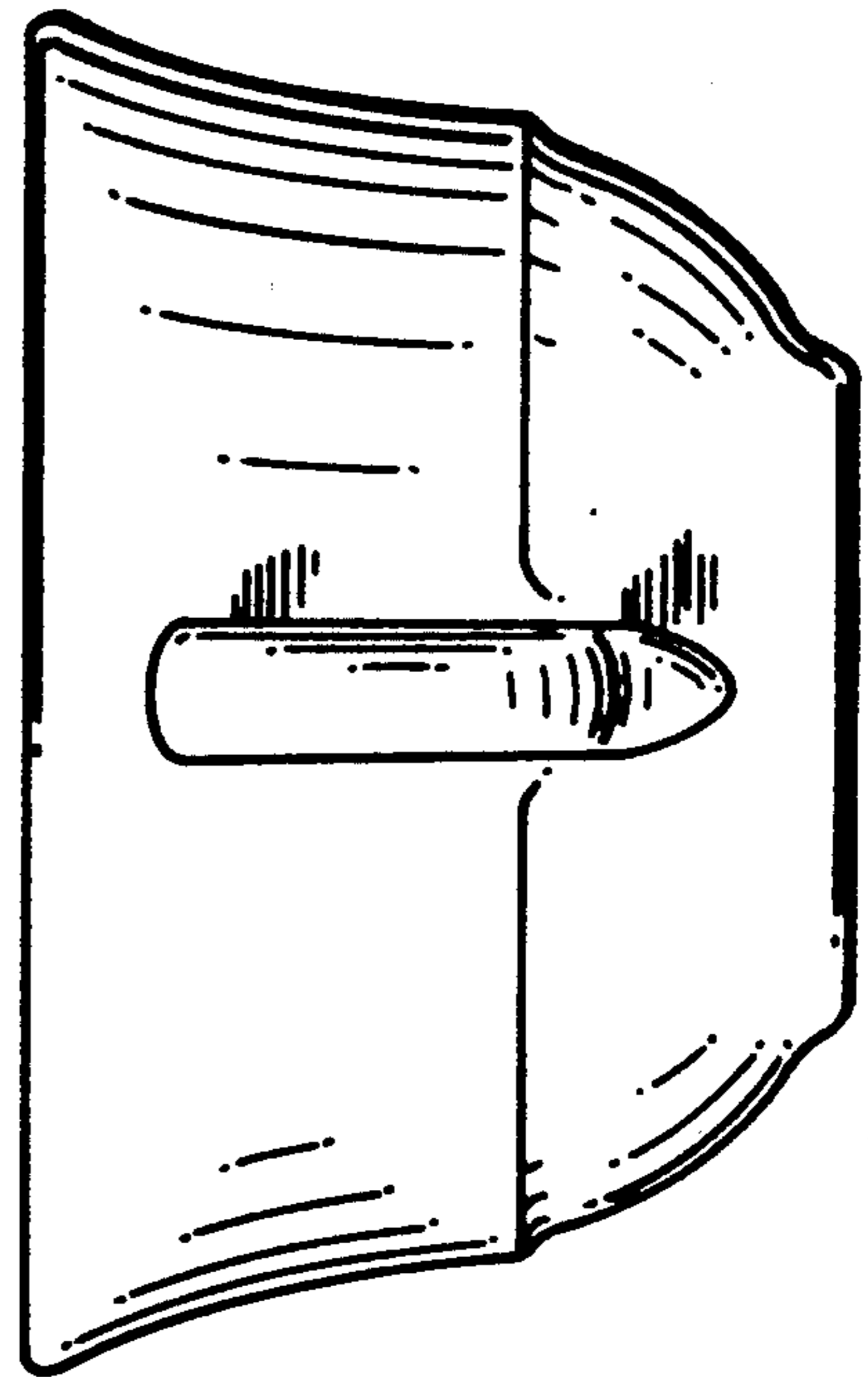

FIG. 1

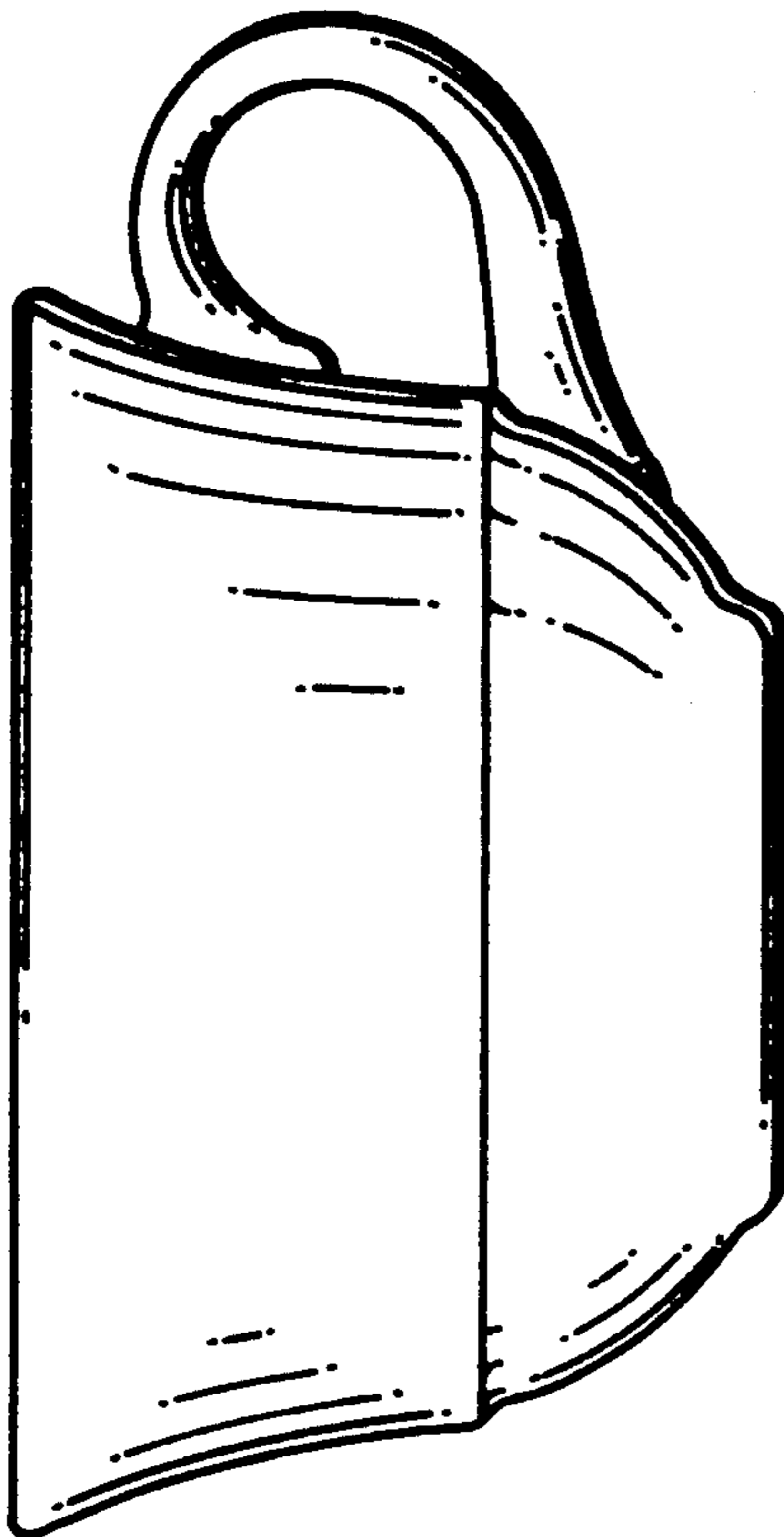
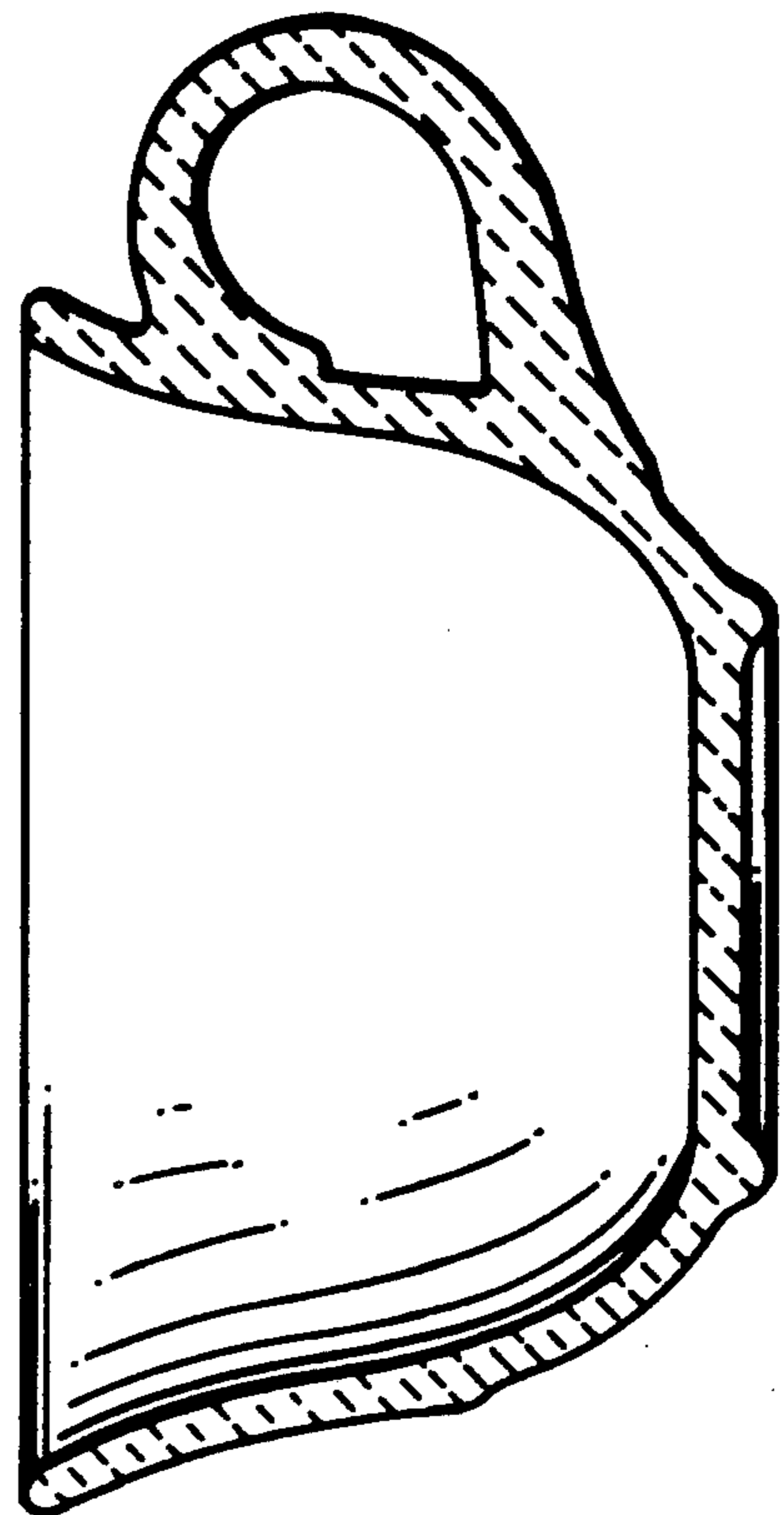
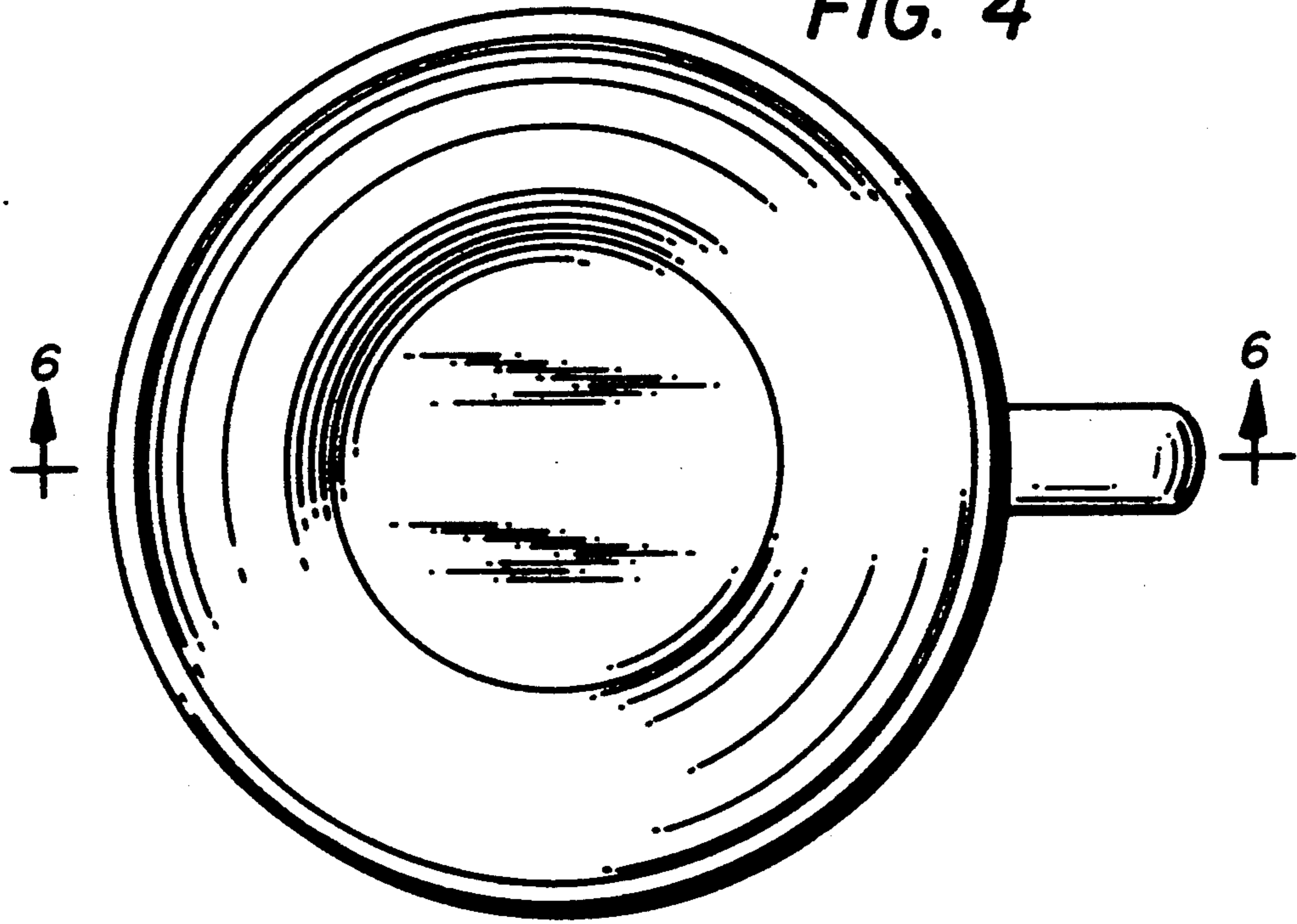

FIG. 6



**FIG. 4**



**FIG. 5**

