

[54] **HAND HELD SPRAYER**

[75] **Inventor: Benjamin H. Stansbury, Jr., Beverly Hills, Calif.**

[73] **Assignee: Modern Faucet Mfg. Co., Los Angeles, Calif.**

[\*\*] **Term: 14 Years**

[21] **Appl. No.: 387,636**

[22] **Filed: Jul. 27, 1989**

[52] **U.S. Cl. .... D23/226**

[58] **Field of Search ..... D23/213, 200, 223-229;  
239/414-415, 301, 332, 373, 394, 525-526,  
588-589, 598, 283**

[56] **References Cited**

**U.S. PATENT DOCUMENTS**

- D. 233,606 11/1974 Raub .
- D. 242,352 11/1976 Uyeda ..... D23/226
- D. 288,228 2/1987 Shames et al. .... D23/226
- D. 289,545 4/1987 Koch ..... D23/223
- D. 292,227 10/1987 Rudelick ..... D23/226
- D. 308,093 5/1990 Mill et al. .... D23/226
- 4,151,957 5/1979 Gecewicz et al. .... 239/530 X

*Primary Examiner—Susan J. Lucas*  
*Assistant Examiner—M. H. Tung*

*Attorney, Agent, or Firm—Lackenbach Siegel Marzullo & Aronson*

[57] **CLAIM**

The ornamental design for a hand held sprayer, as shown and described.

**DESCRIPTION**

FIG. 1 is a perspective view of a hand held sprayer showing my new design;  
FIG. 2 is a side elevational view thereof;  
FIG. 3 is a front elevational view thereof;  
FIG. 4 is a rear elevational view thereof;  
FIG. 5 is a top plan view thereof;  
FIG. 6 is a bottom plan view thereof;  
FIG. 7 is a fragmentary cross-sectional view thereof, taken along 7—7 of FIG. 2;  
FIG. 8 is a fragmentary cross sectional view thereof, taken along 8—8 of FIG. 2;  
FIG. 9 is a fragmentary cross sectional view thereof, taken along 8—8 of FIG. 2;  
FIG. 10 is a fragmentary cross sectional view thereof, taken along 10—10 of FIG. 2;  
FIG. 11 is a fragmentary cross sectional view thereof, taken along 11—11 of FIG. 2;  
FIG. 12 is a cross sectional view thereof, taken along 12—12 of FIG. 2.

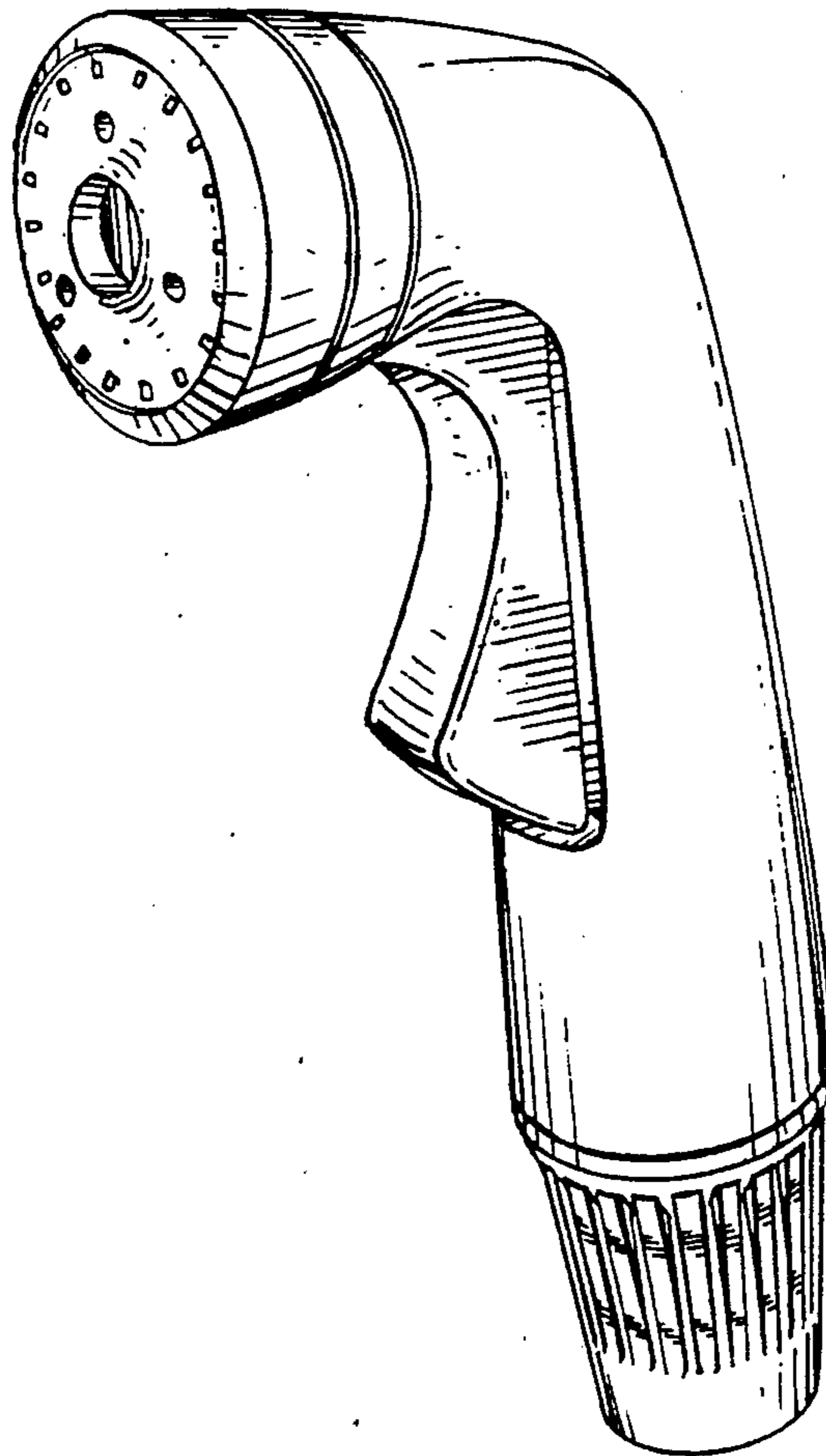

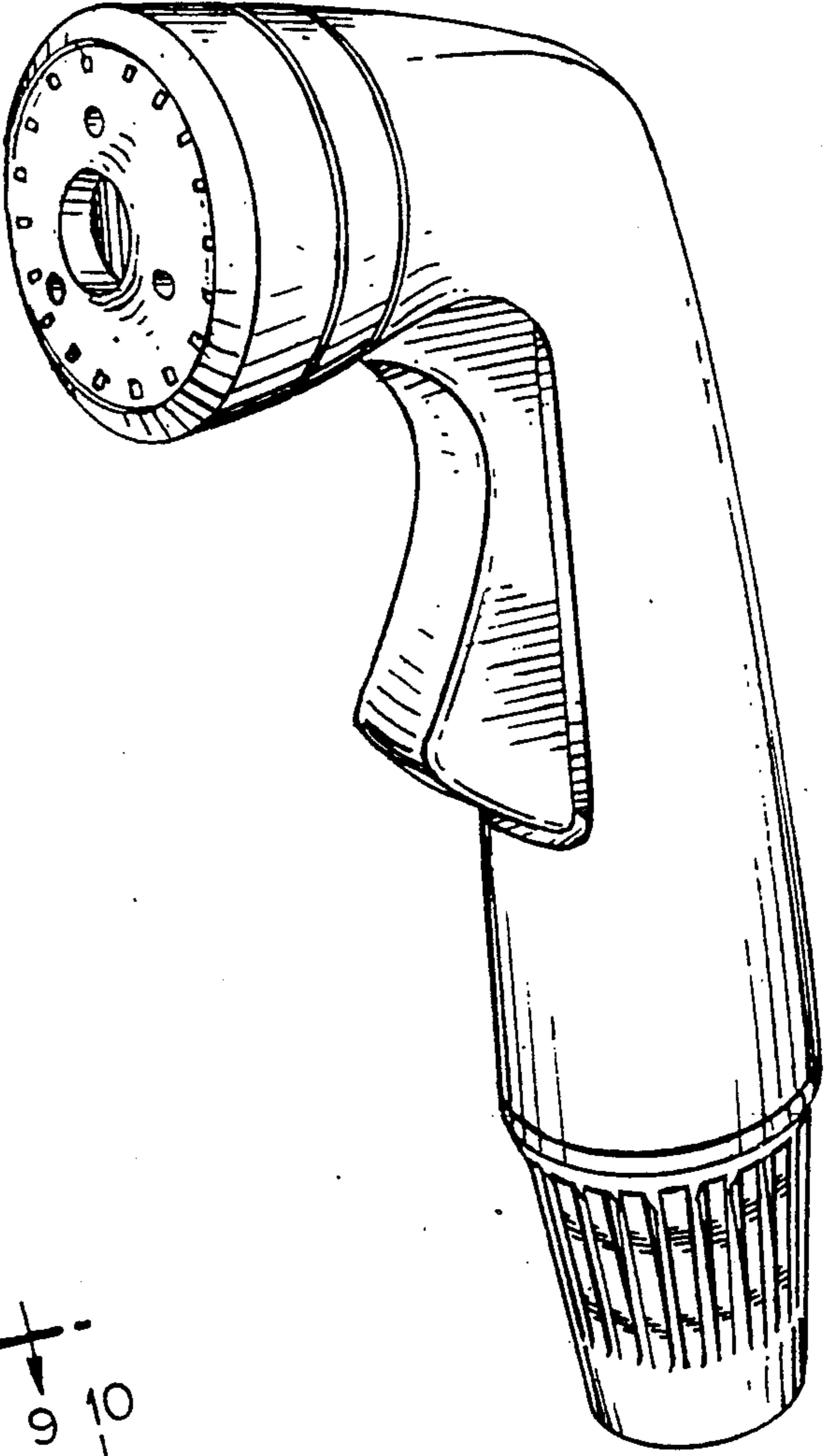

FIG. 1

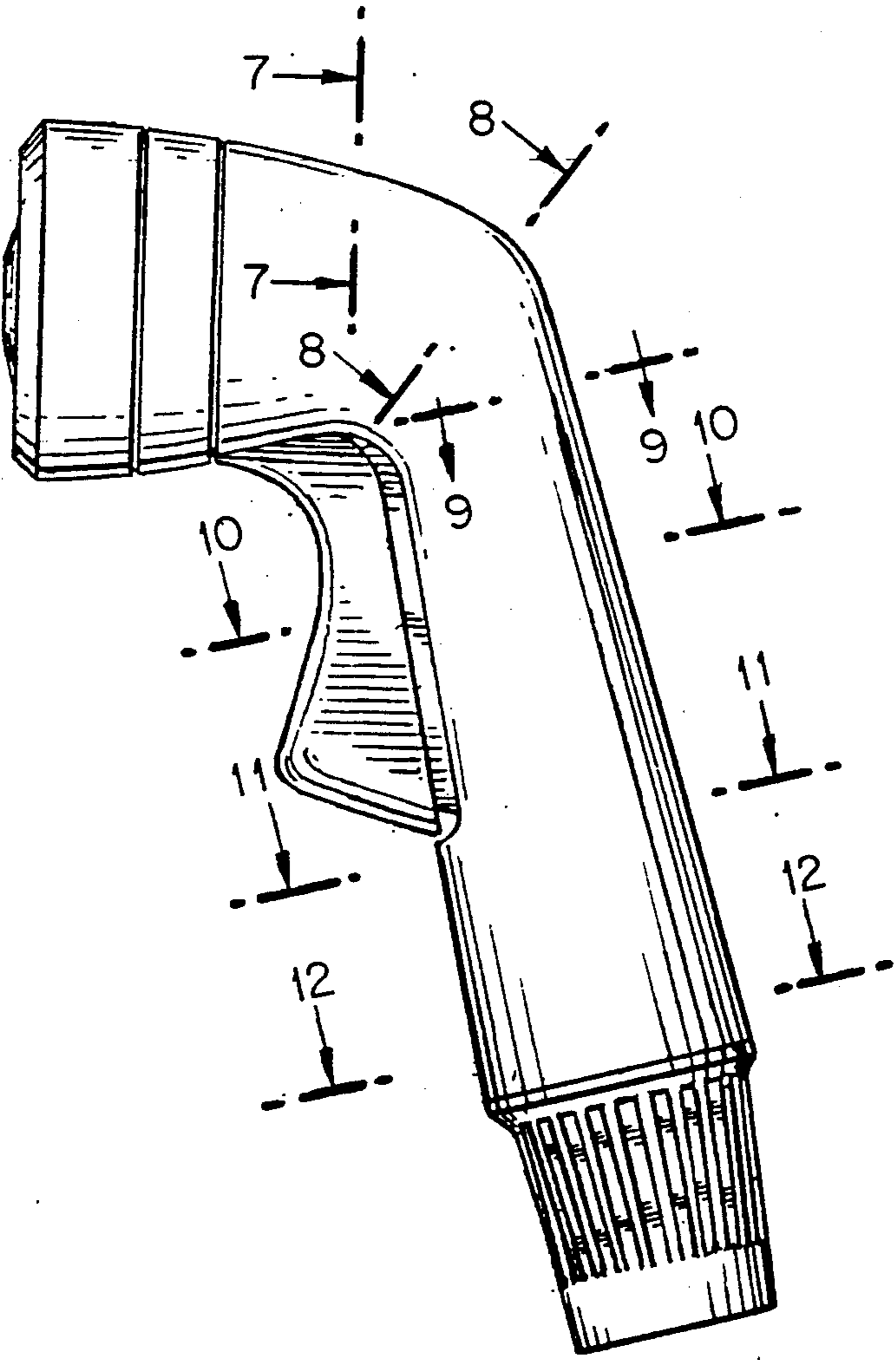

FIG. 2

FIG. 3

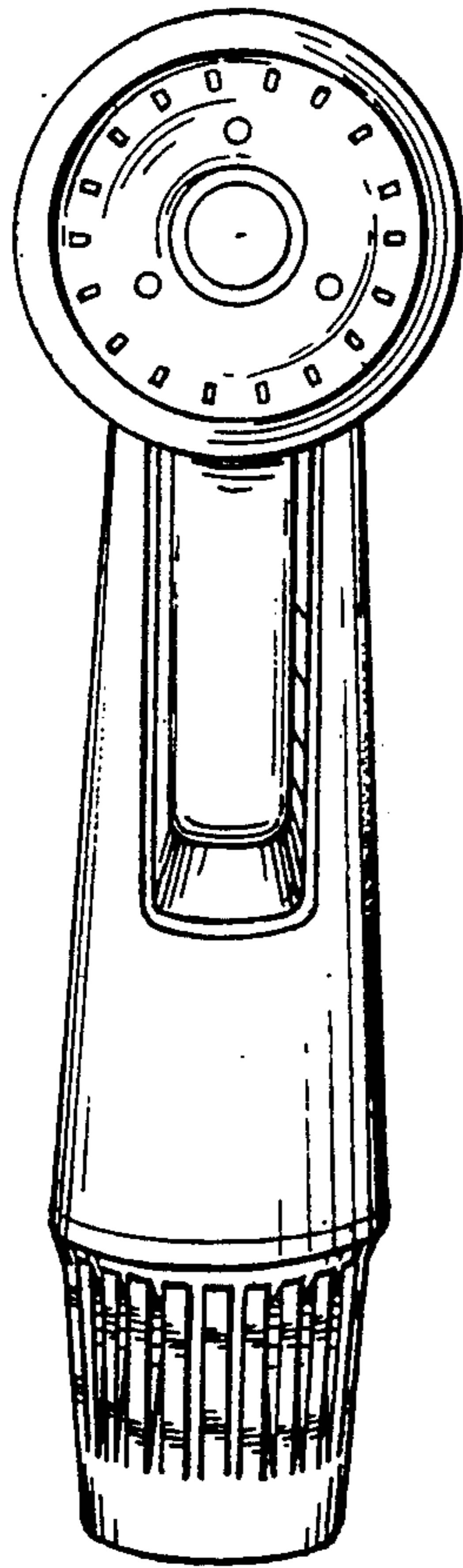

FIG. 4

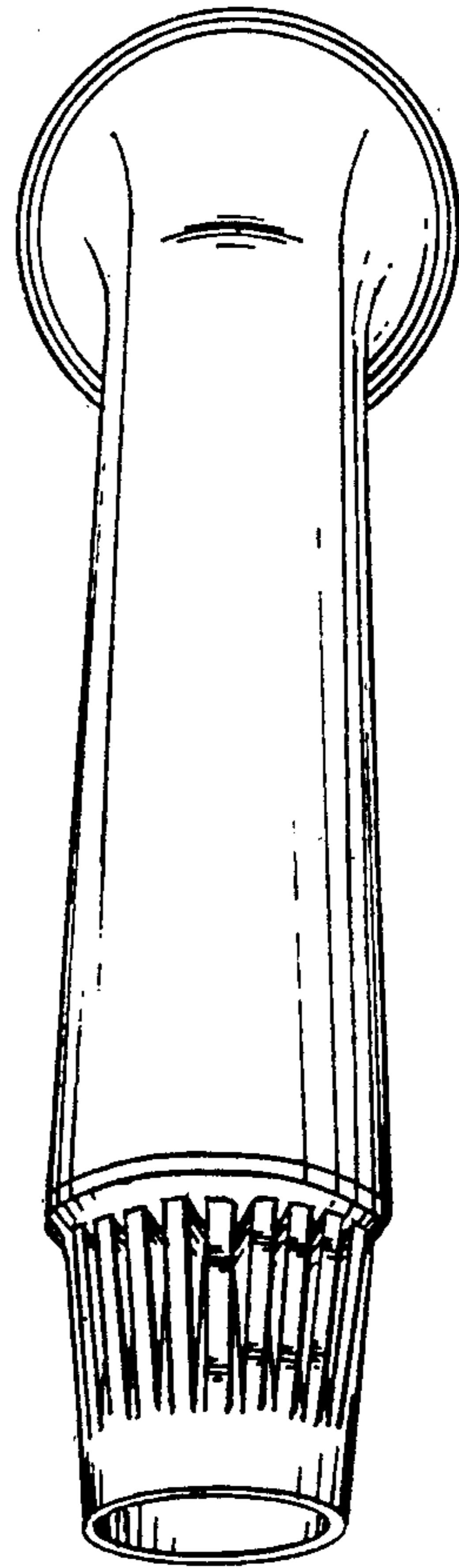

FIG. 5

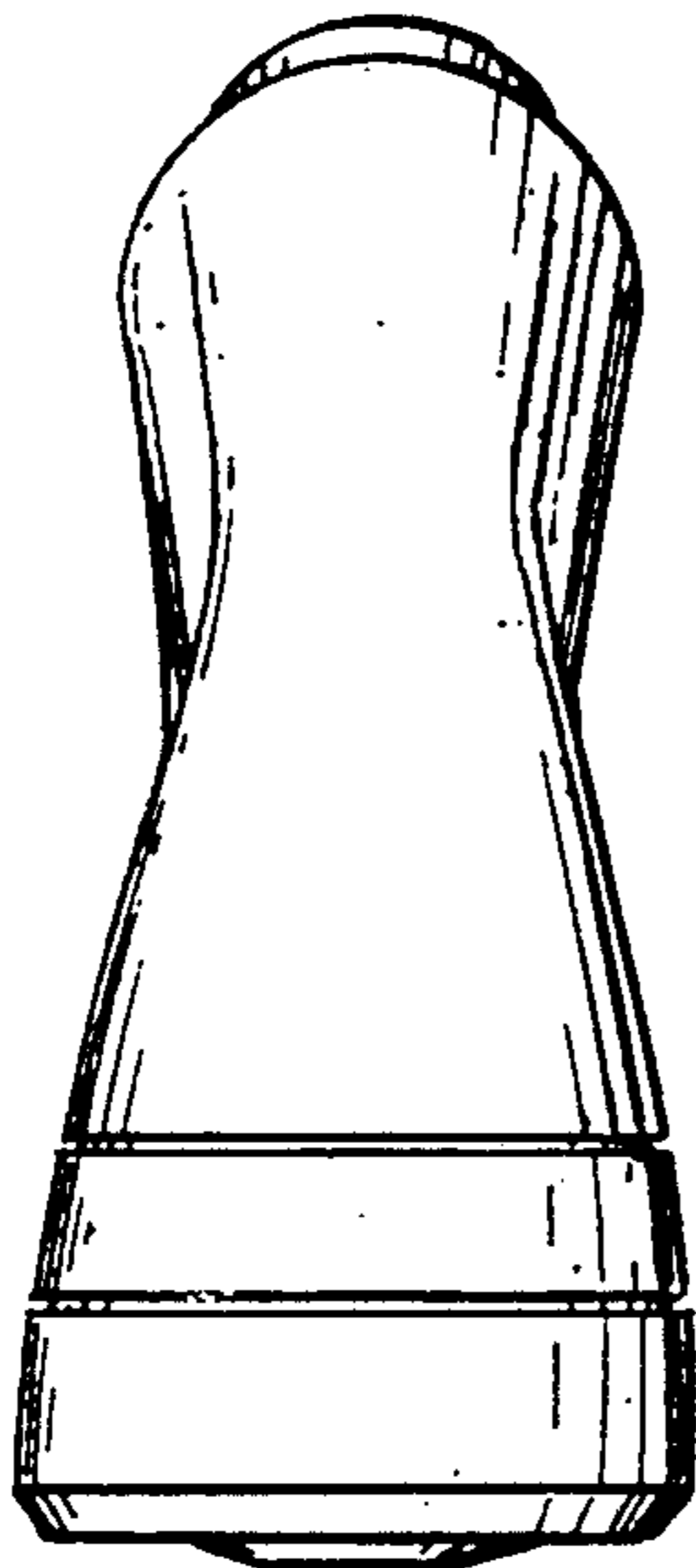

FIG. 6

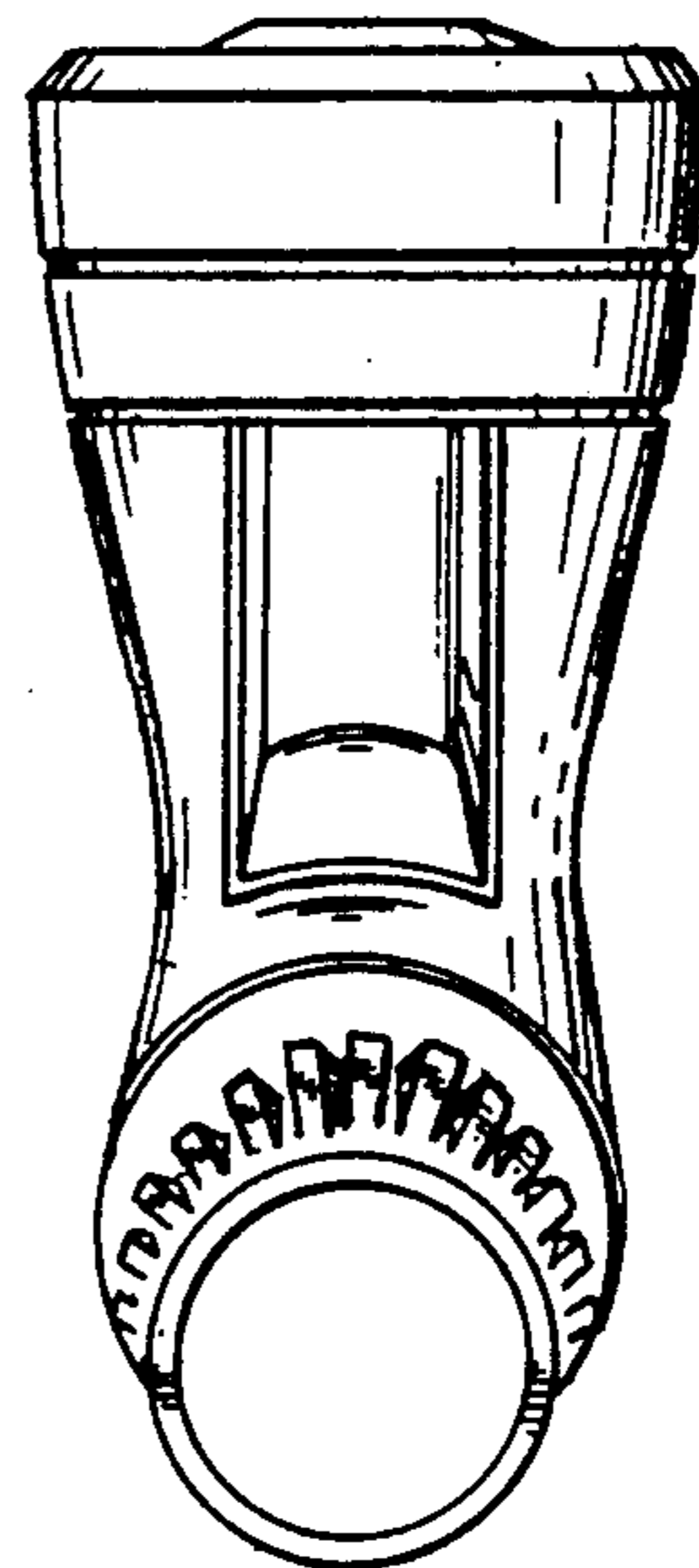

FIG. 7

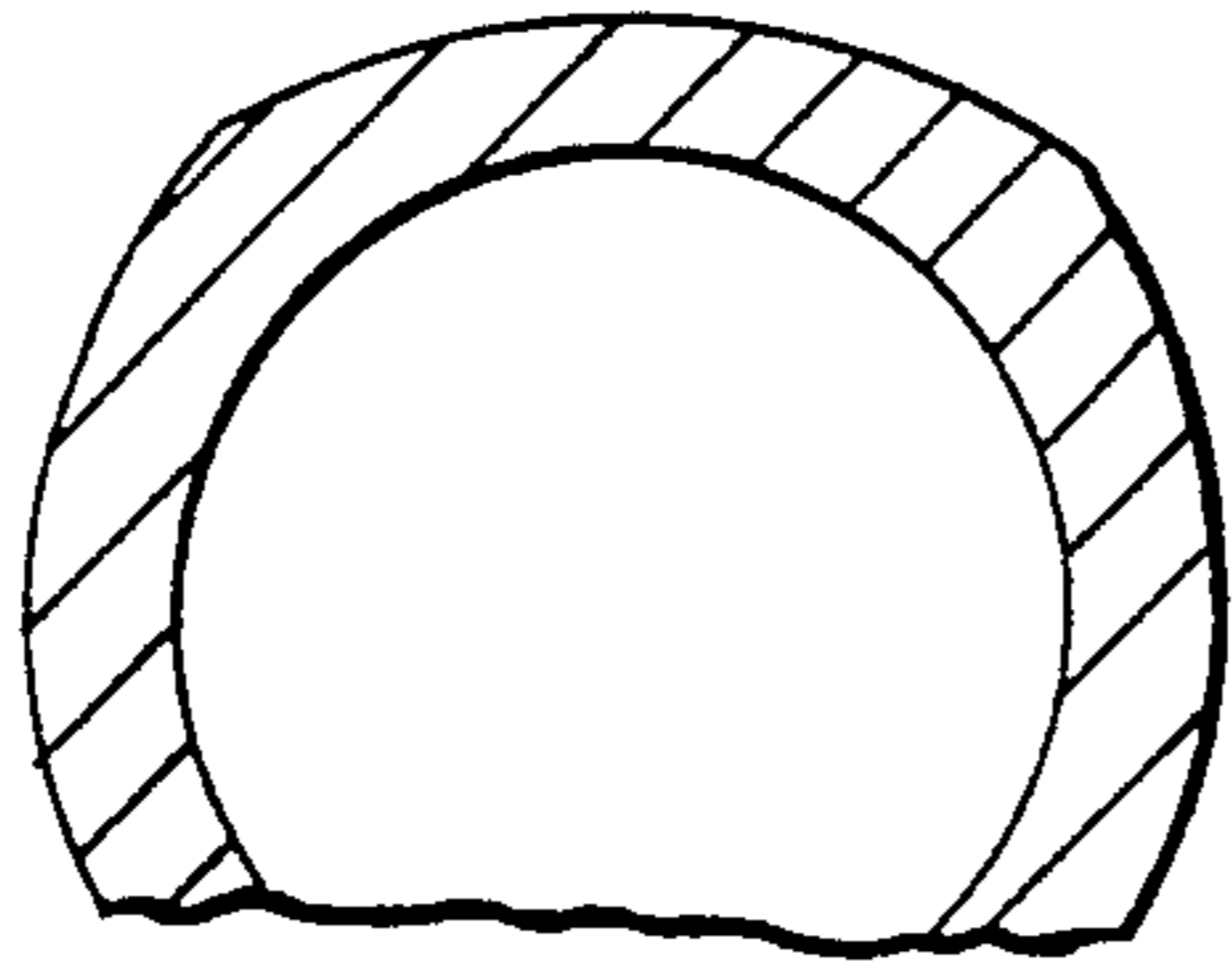

FIG. 8

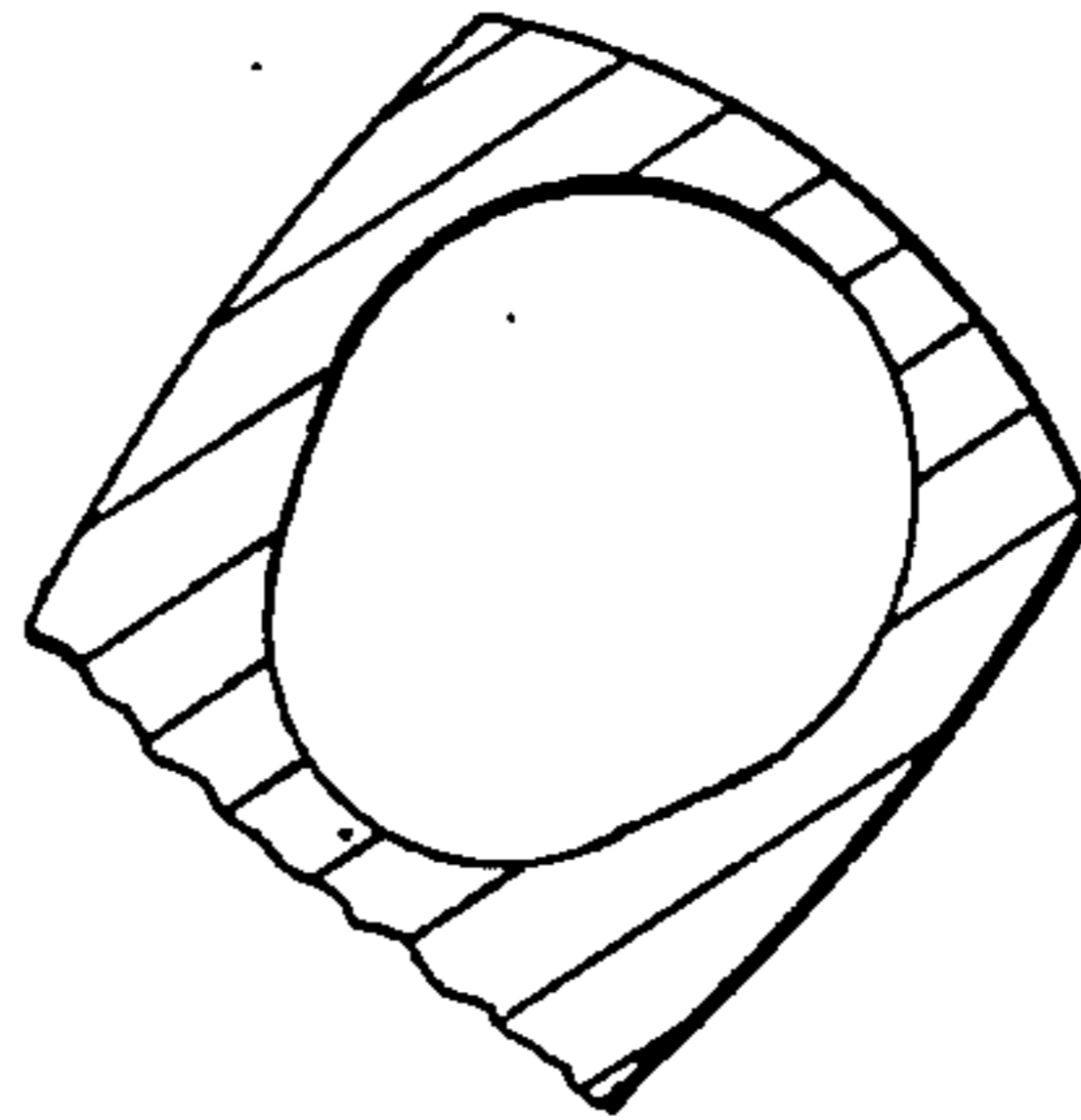

FIG. 9

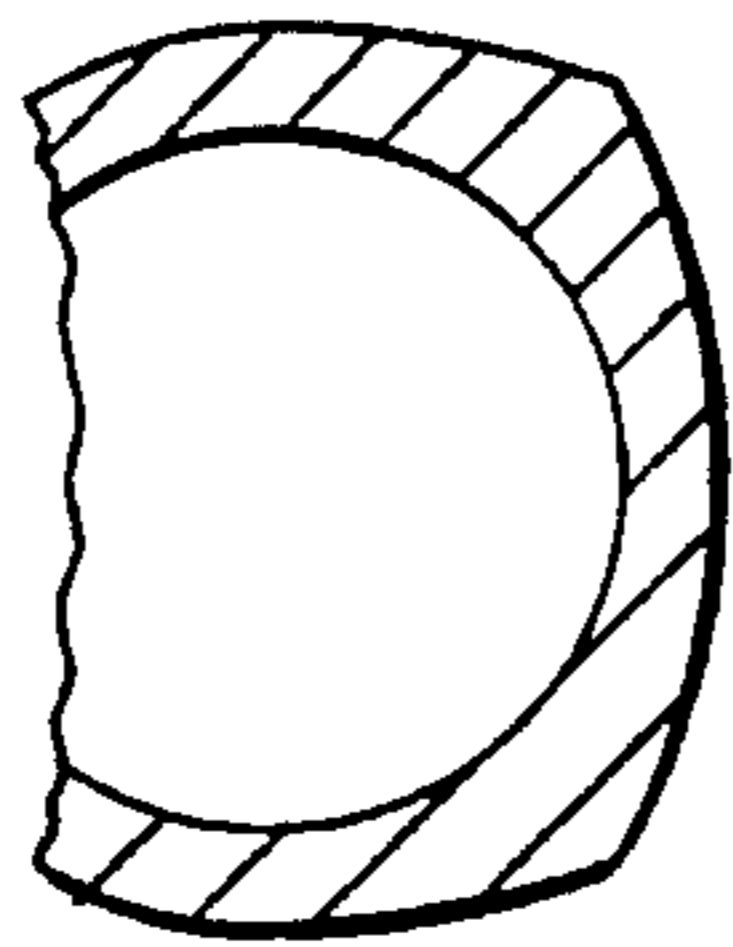

FIG. 10

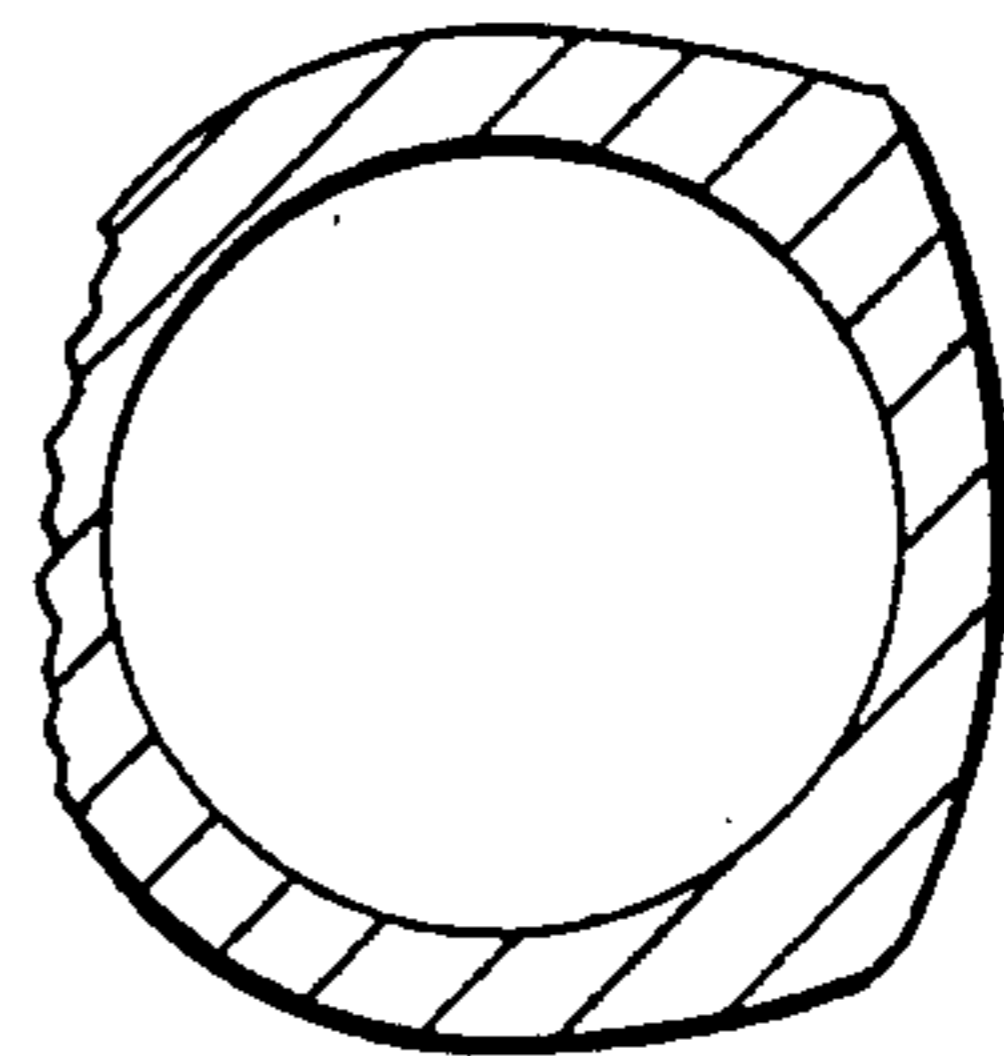

FIG. 11

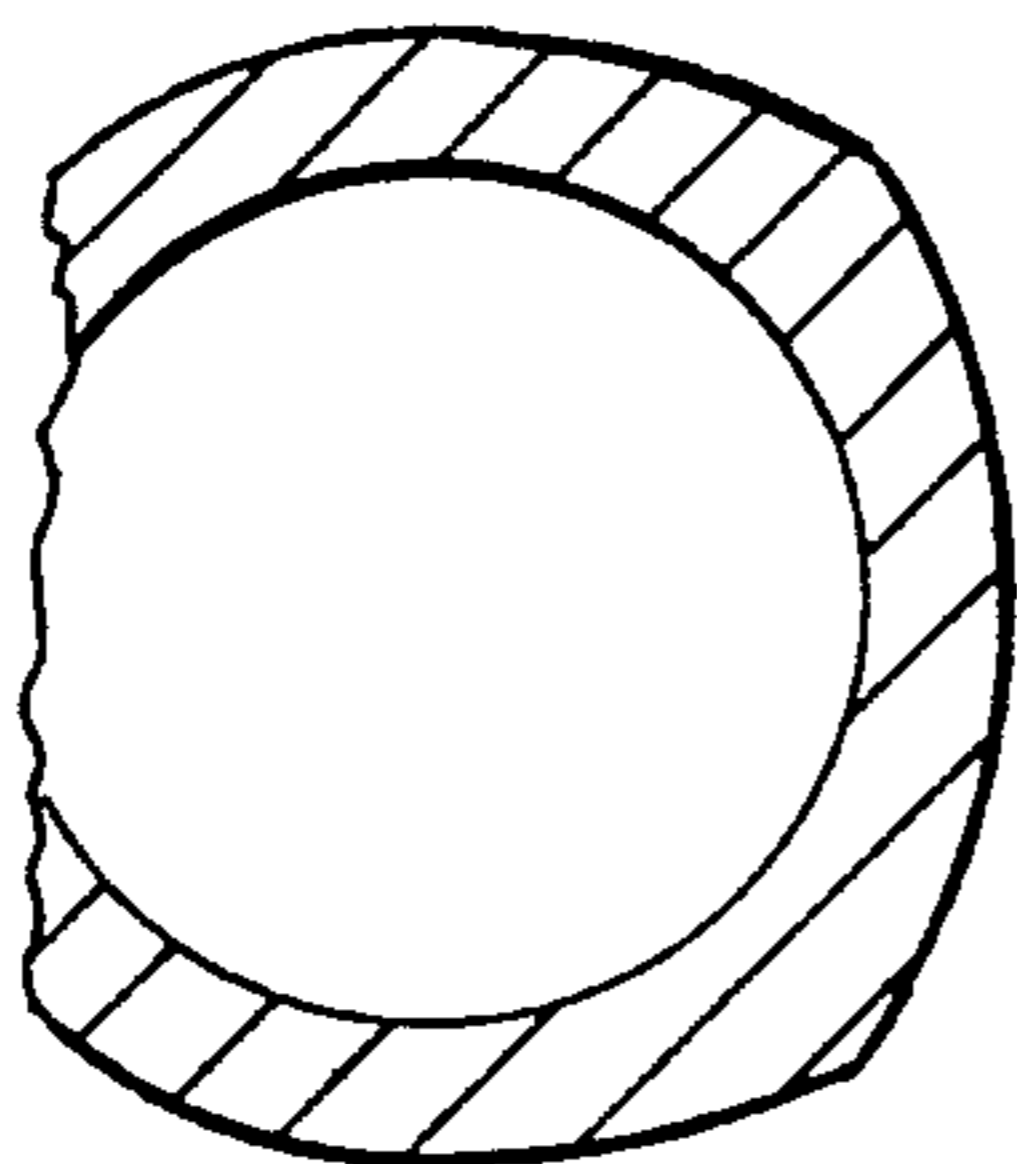

FIG. 12

