

[54] **COMBINED TWO-LEVEL PAPER TRAY
AND WRITING INSTRUMENT HOLDER**

[75] Inventor: Robert G. Cornell, Duxbury, Mass.

[73] Assignee: Cornell Concepts Corp., Taunton,
Mass.

[**] Term: 14 Years

[21] Appl. No.: 350,025

[22] Filed: May 10, 1989

[52] U.S. Cl. D19/78; D19/84;
D19/86; D19/92

[58] Field of Search D19/65, 75, 77, 78,
D19/81, 84, 86, 92, 95; 206/215, 555; 211/126,
128, 10, 11, 45, 50

[56] **References Cited**

U.S. PATENT DOCUMENTS

D. 46,984	2/1915	Lindsay	D19/83
D. 101,710	10/1936	Patterson	D19/92 X
D. 108,273	2/1938	Winstrom	D19/92
D. 122,471	9/1940	Seigenberg	D19/92
D. 125,415	2/1941	Freligh	D19/92
D. 136,711	11/1943	Clark	D19/92
D. 154,560	7/1949	McCay et al.	D19/92
D. 163,463	5/1951	Lewis	D19/92
D. 165,538	12/1951	Moore	D19/83 X

D. 167,734	9/1952	Applebaum	D19/92
D. 171,865	3/1954	Roth	D19/92
D. 179,480	1/1957	Jones et al.	D19/92 X
D. 209,548	12/1967	Wittenberg	D19/92
2,901,120	8/1959	Abrahamson	211/126
3,028,975	4/1962	Bullock	211/126
4,074,810	2/1978	Juergens et al.	211/11
4,534,475	8/1985	Mayo	211/126
4,657,148	4/1987	Heng	211/128

Primary Examiner—Bruce W. Dunkins
Assistant Examiner—Martha Thompson

[57] **CLAIM**

The ornamental design for a combined two-level paper tray and writing instrument holder, as shown and described.

DESCRIPTION

FIG. 1 is a top left front perspective view of a combined two-level paper tray and writing instrument holder showing my new design;
FIG. 2 is a top plan view on a reduced scale;
FIG. 3 is a front elevational view of FIG. 2;
FIG. 4 is a rear elevational view of FIG. 2;
FIG. 5 is a left side elevational view of FIG. 2;
FIG. 6 is a right side elevational view of FIG. 2;
FIG. 7 is a bottom plan view of FIG. 2; and
FIG. 8 is a cross-sectional view taken in the direction of arrows 8—8 in FIG. 2.

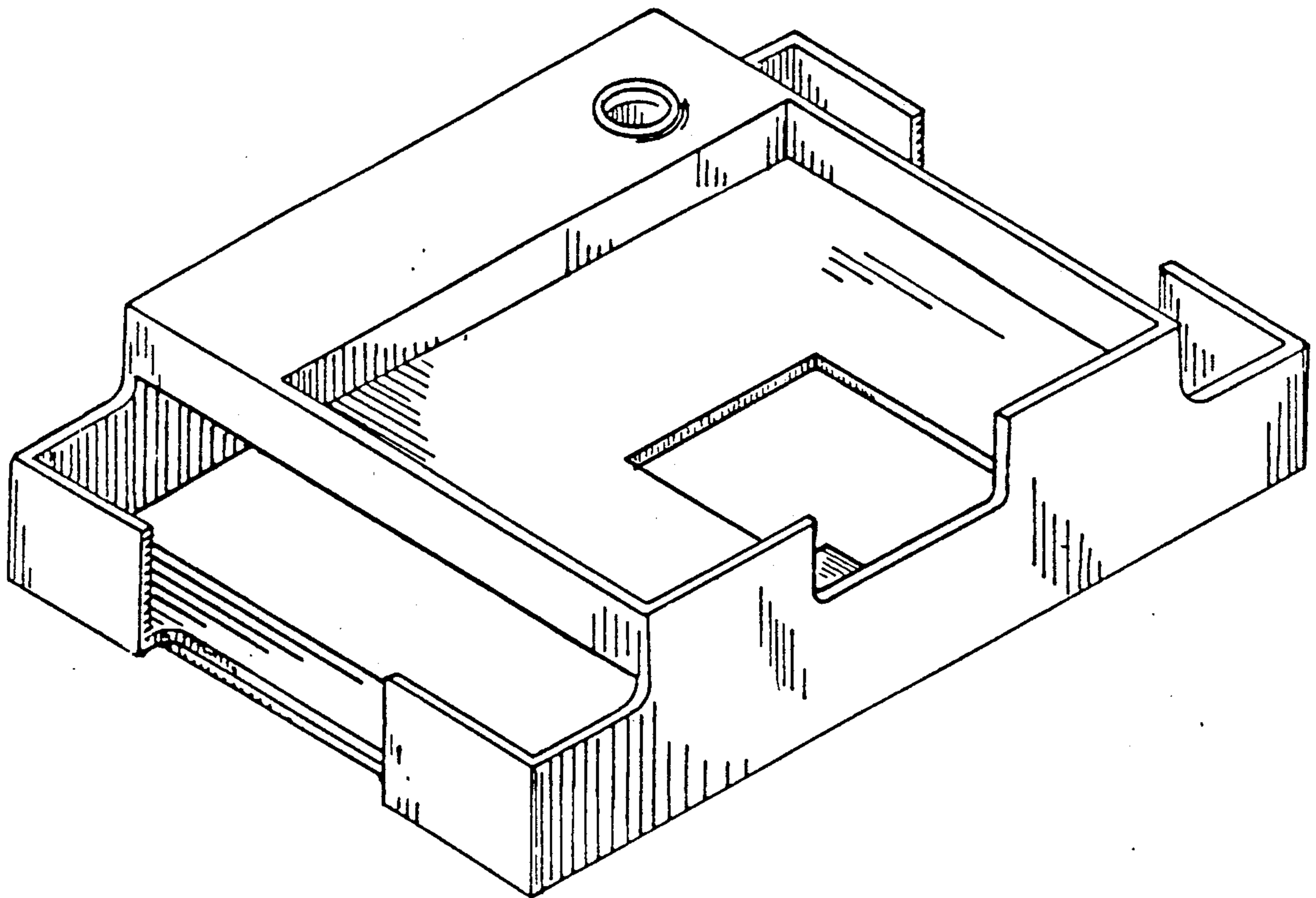

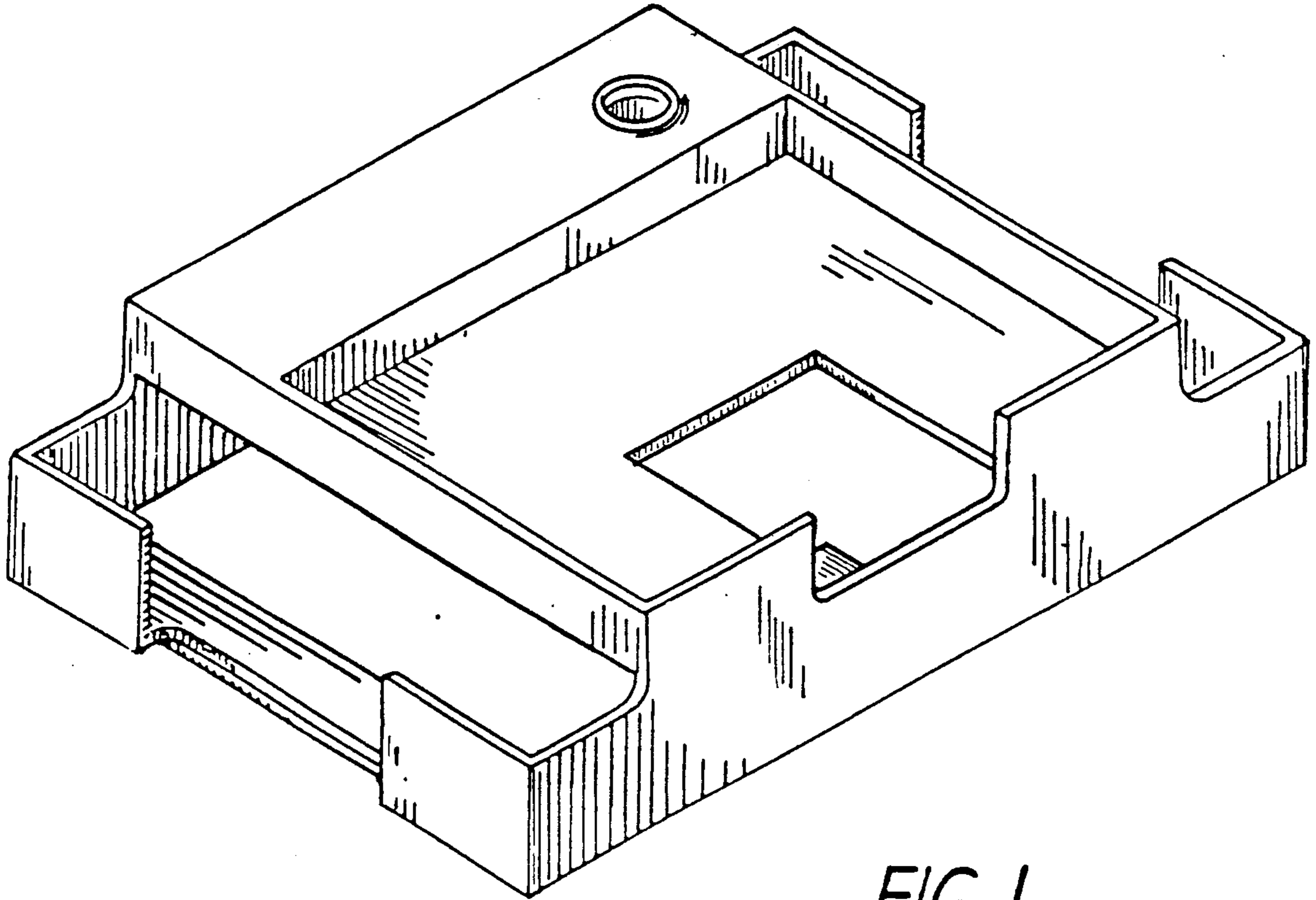

FIG. 1

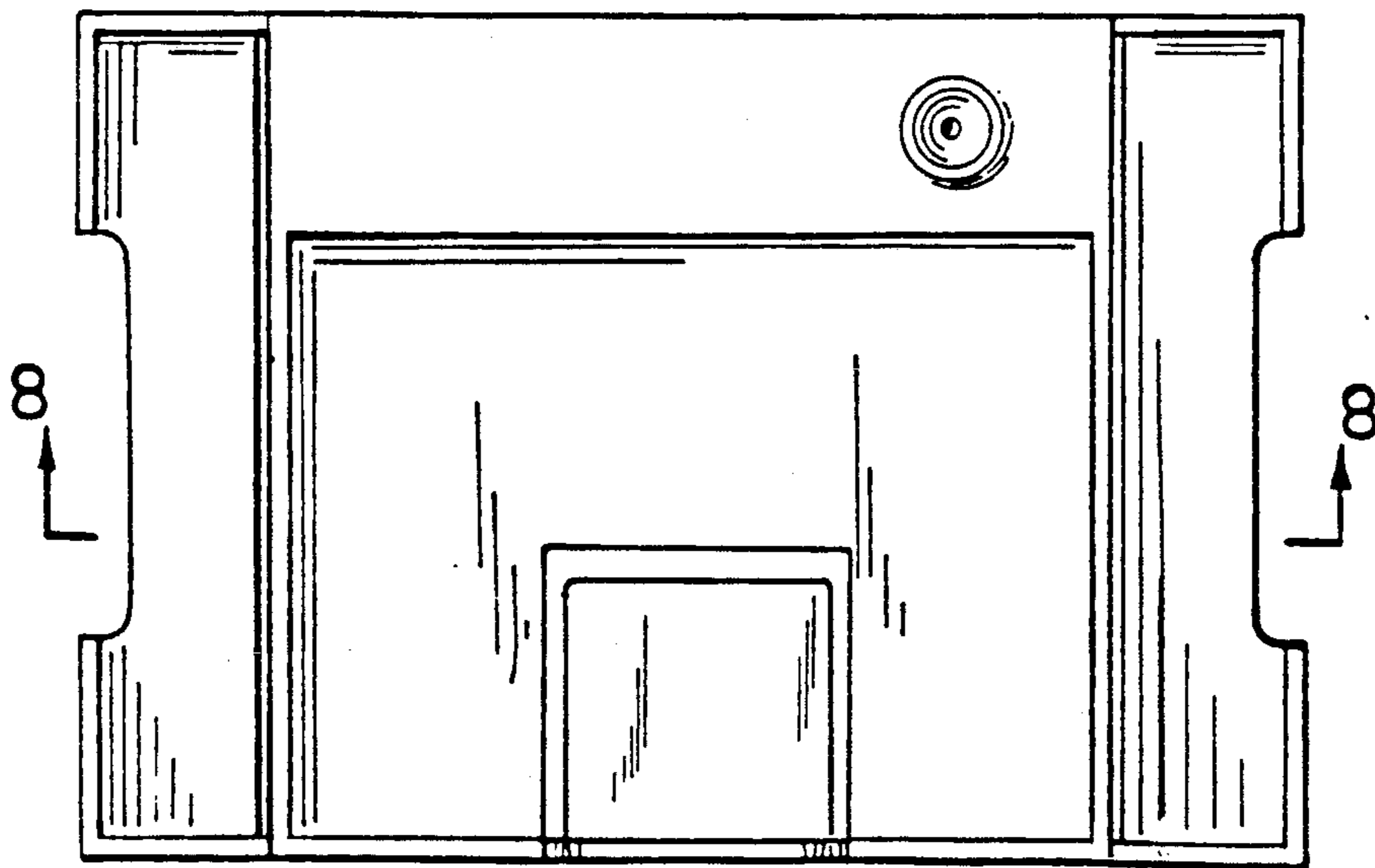

FIG. 2

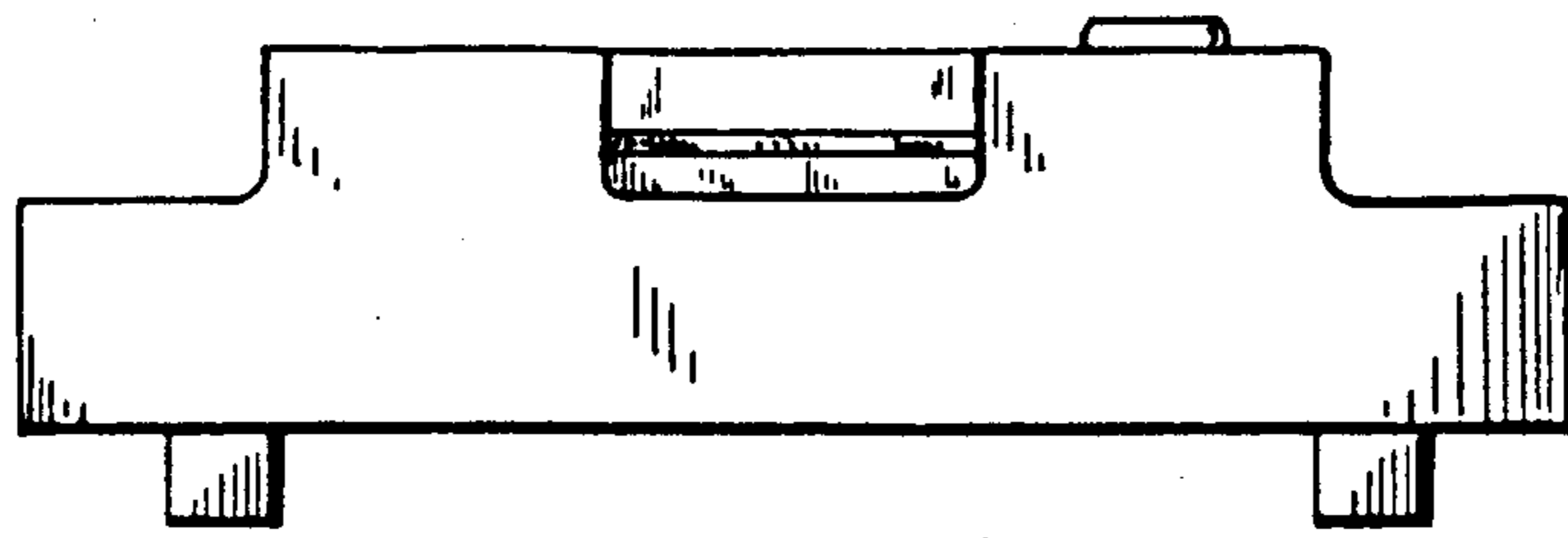

FIG. 3

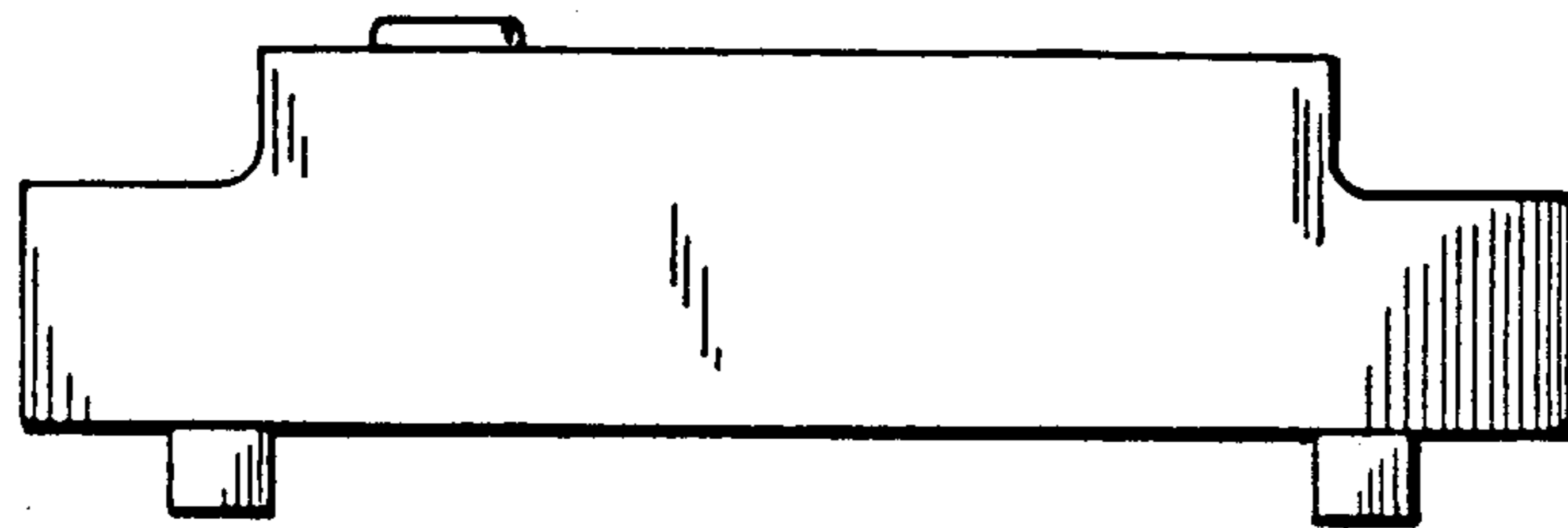

FIG. 4

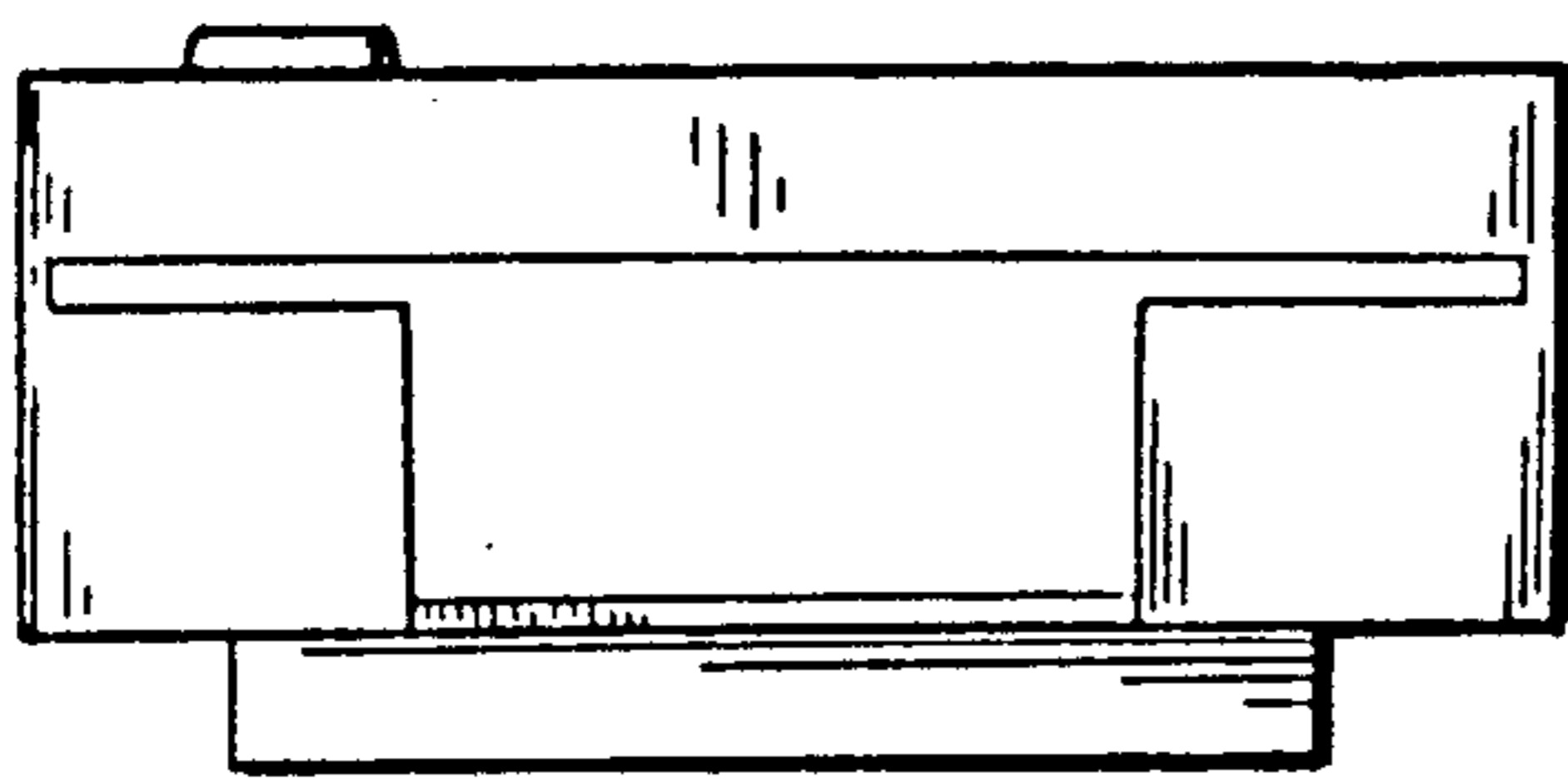

FIG. 5

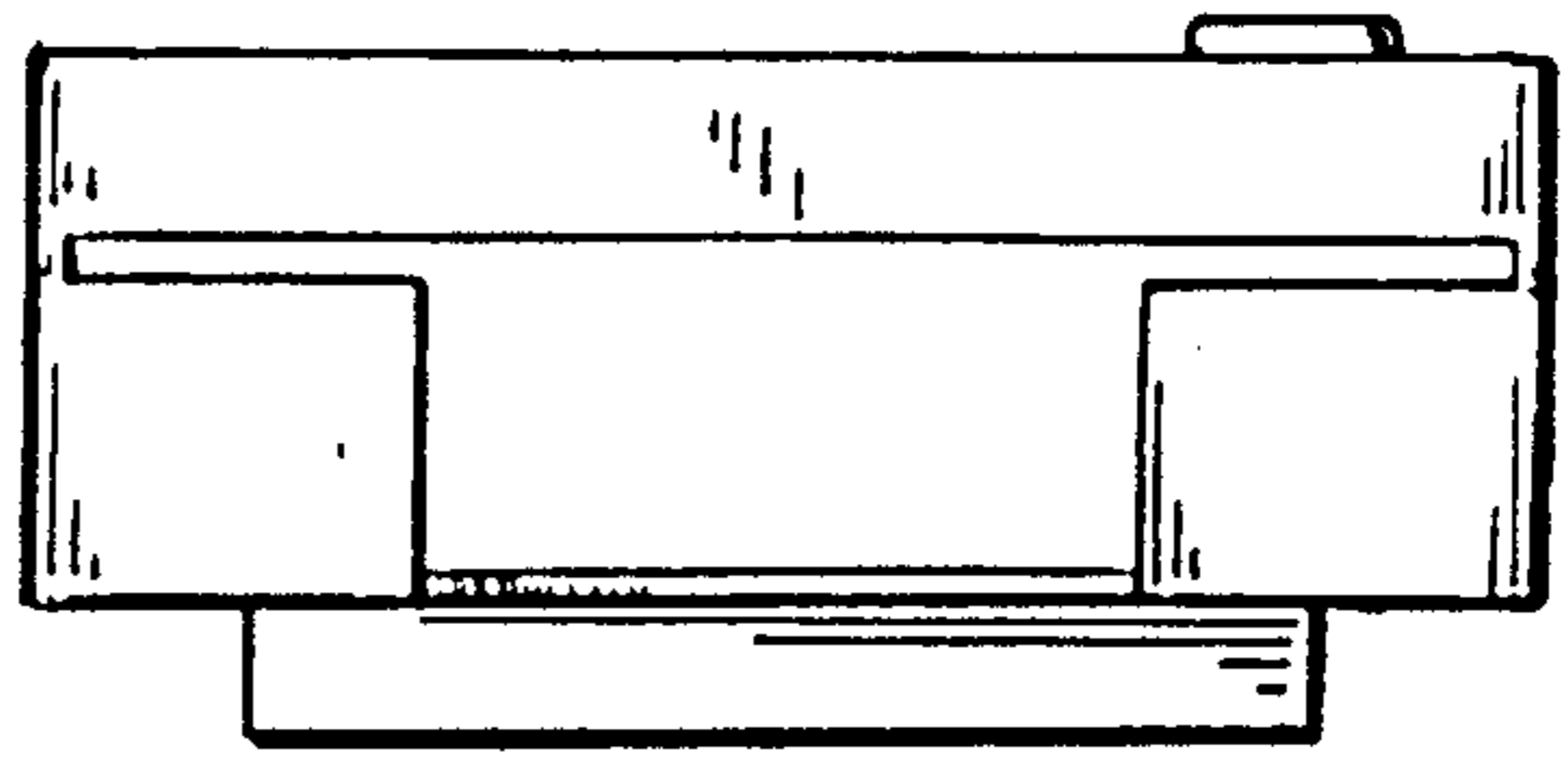

FIG. 6

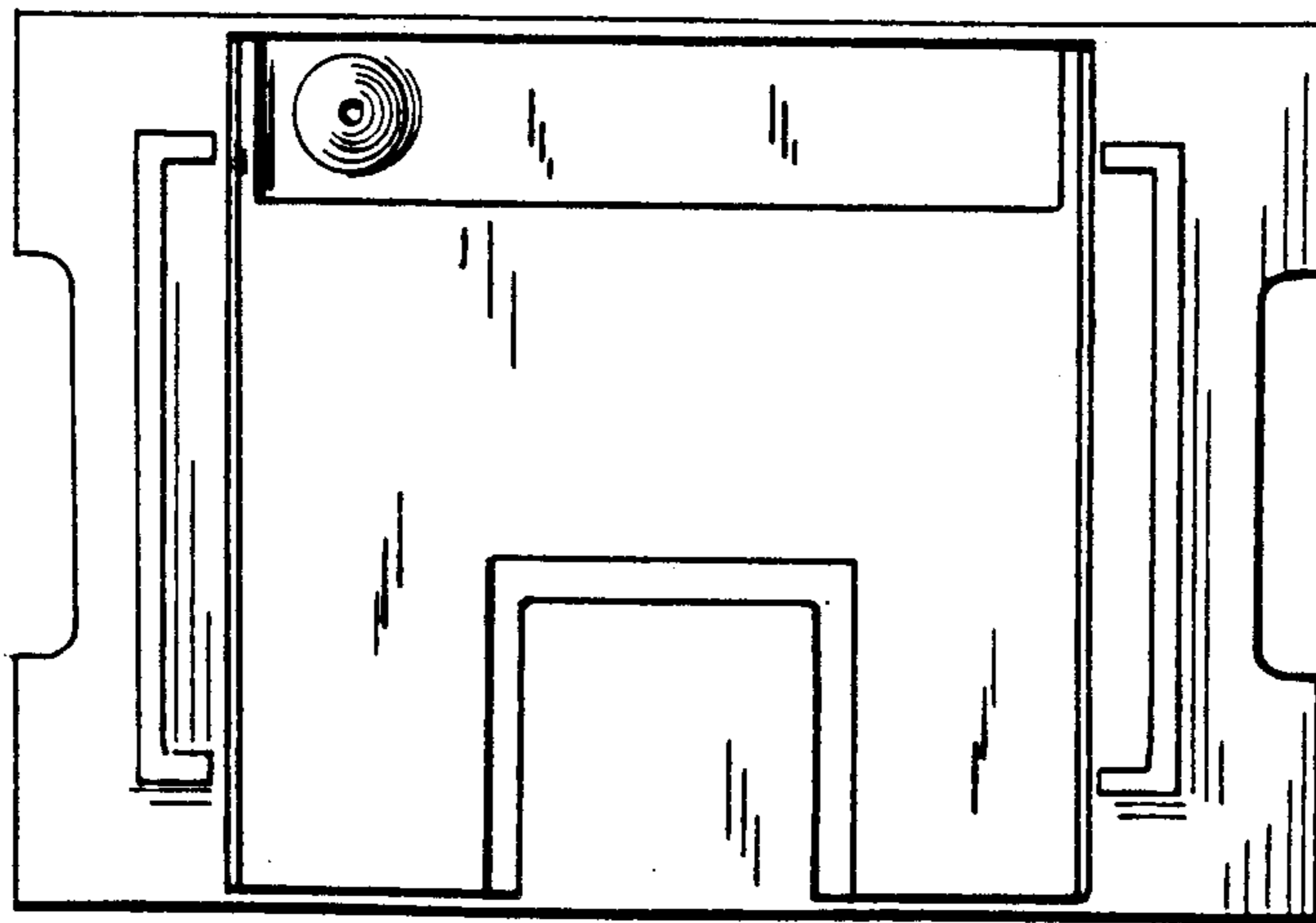

FIG. 7

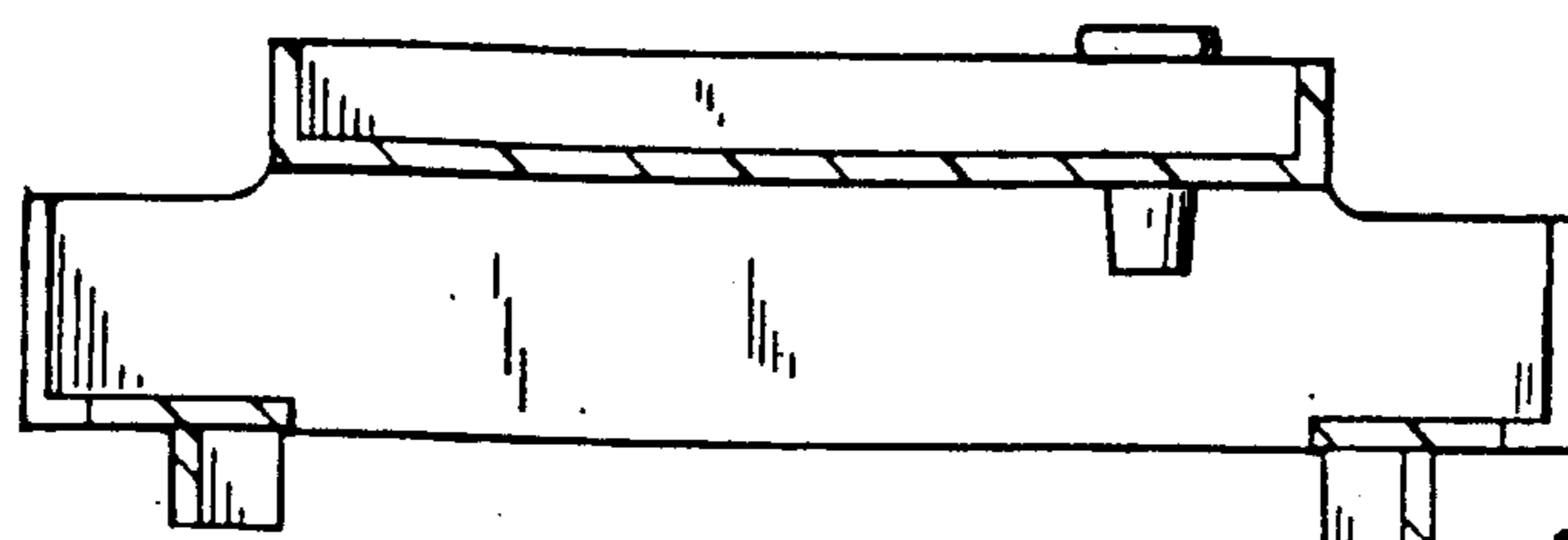

FIG. 8