

[54] **LAVATORY**  
 [75] **Inventor: Rik Cuttriss, Fillmore, Calif.**  
 [73] **Assignee: Gruber Systems, Inc., Valencia, Calif.**  
 [\*\*] **Term: 14 Years**  
 [21] **Appl. No.: 448,595**  
 [22] **Filed: Dec. 11, 1989**  
 [52] **U.S. Cl. .... D23/294**  
 [58] **Field of Search .... D23/270-274,  
 D23/287-294, 308; 4/619, 625, 630-659**

D. 240,825 8/1976 Gruber ..... D23/294  
 D. 260,678 9/1981 Hiller ..... D23/294 X  
 D. 262,485 12/1981 Wissinger ..... D23/284 X  
 D. 315,402 3/1991 Lenahan ..... D23/294

**OTHER PUBLICATIONS**

Ingersoll-Humphryes Div. of Borg-Warner Corp. Brochure, p. 2, bottom 2 rows of sinks.

*Primary Examiner*—James R. Largen  
*Attorney, Agent, or Firm*—Poms, Smith, Lande & Rose

[57] **CLAIM**

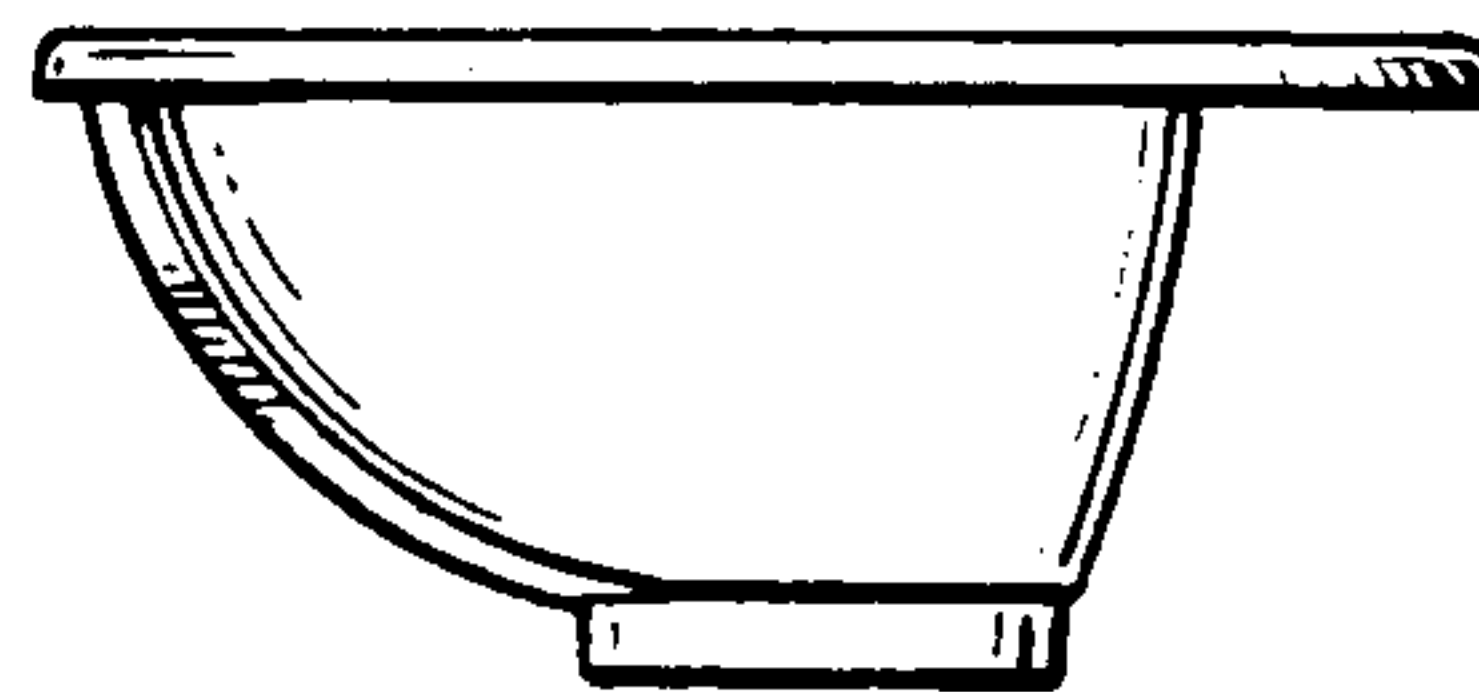
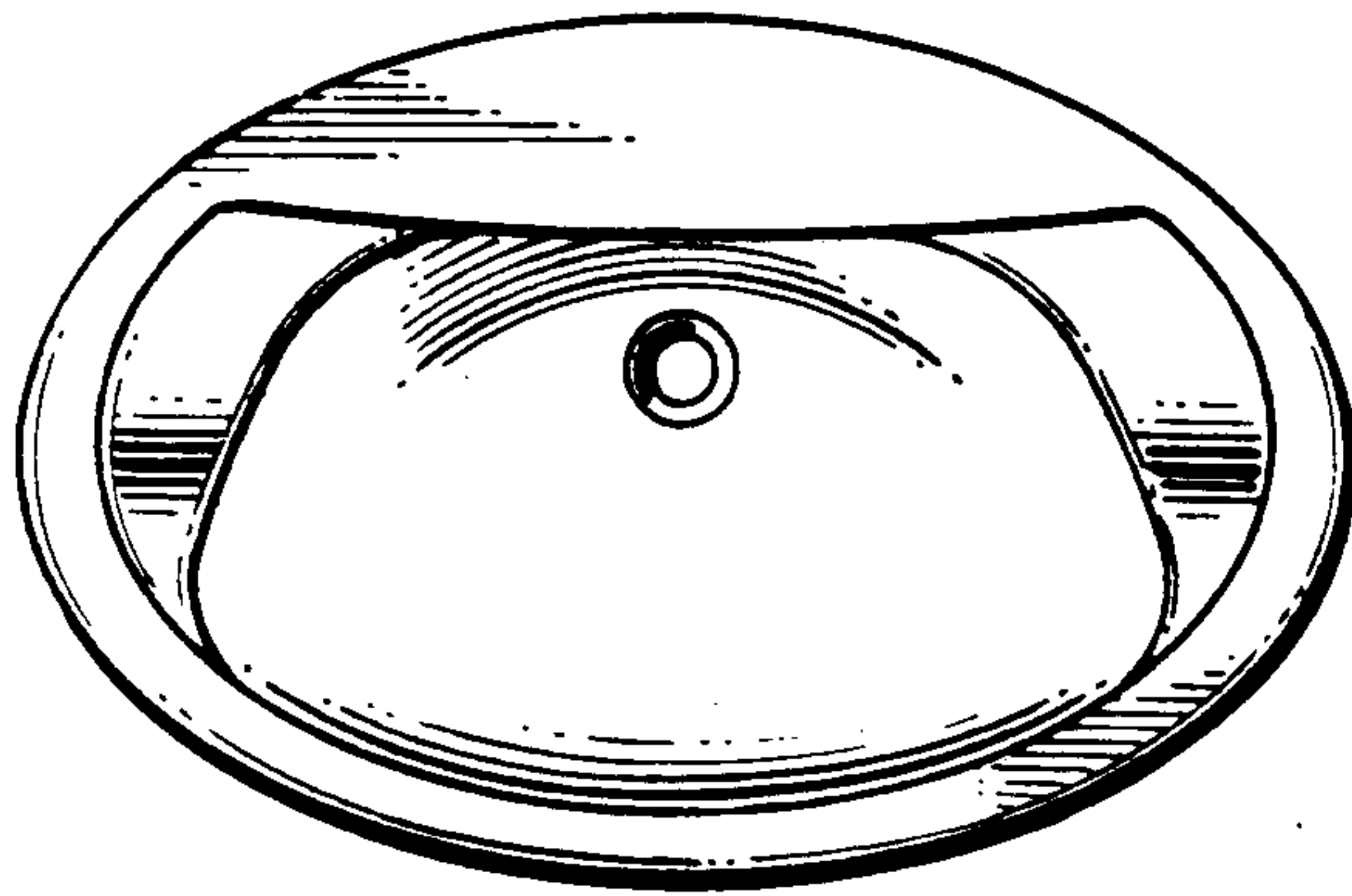
The ornamental design for a lavatory, as shown and described.

[56] **References Cited**  
**U.S. PATENT DOCUMENTS**

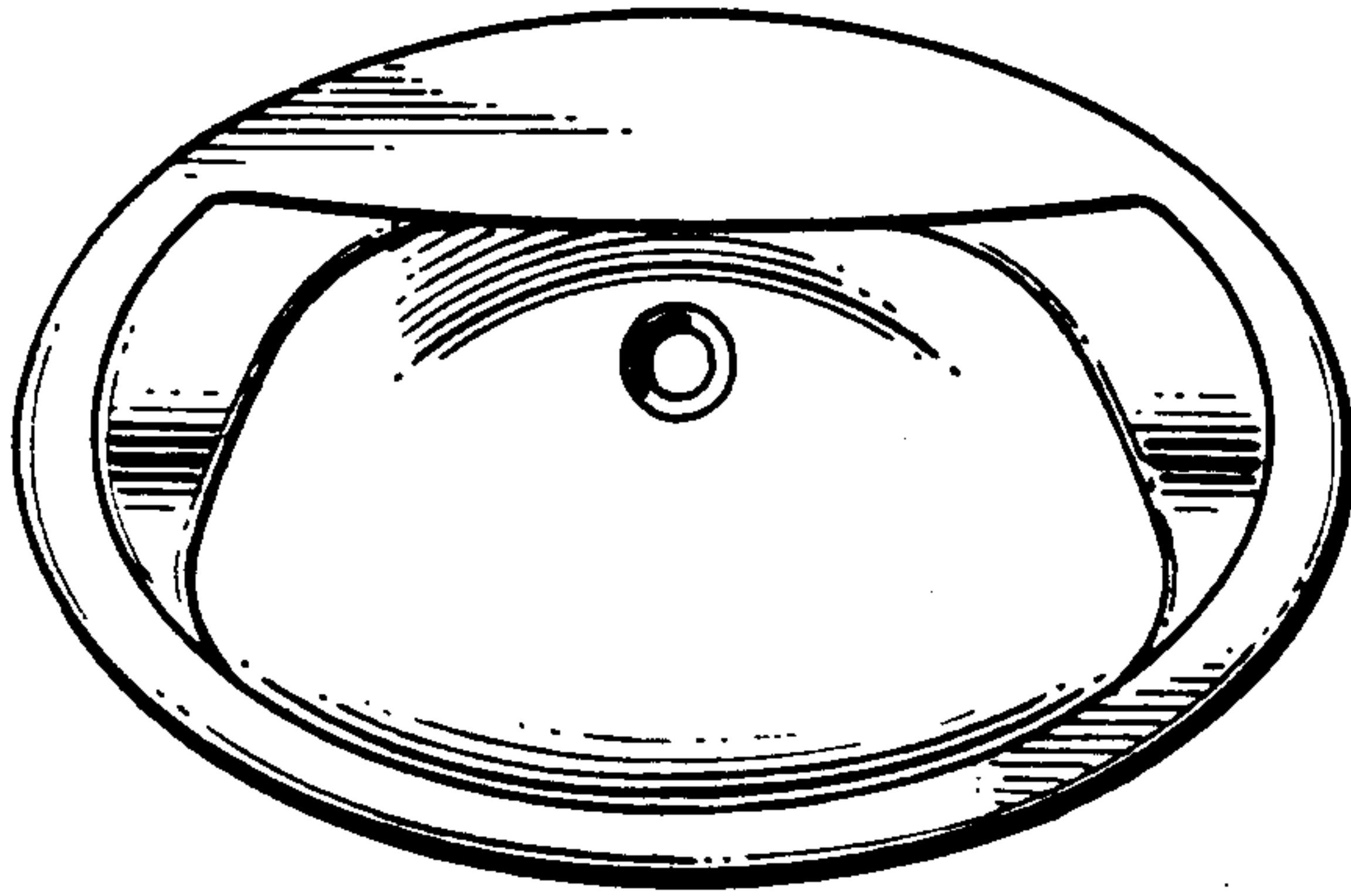
D. 177,587 5/1956 Ponti ..... D23/294  
 D. 191,432 10/1961 Chapman ..... D23/294  
 D. 191,860 12/1961 Holberson ..... D23/294  
 D. 202,410 9/1965 Sundberg et al. .... D23/294  
 D. 211,524 6/1968 Plantholt ..... D23/294  
 D. 217,967 7/1970 Korol ..... D23/284  
 D. 217,968 7/1970 Armstrong ..... D23/293  
 D. 218,520 8/1970 Audino et al. .... D23/294  
 D. 222,586 11/1971 Hives ..... D23/294  
 D. 232,638 9/1974 Mather ..... D23/284  
 D. 235,344 6/1975 Korol ..... D23/294

**DESCRIPTION**

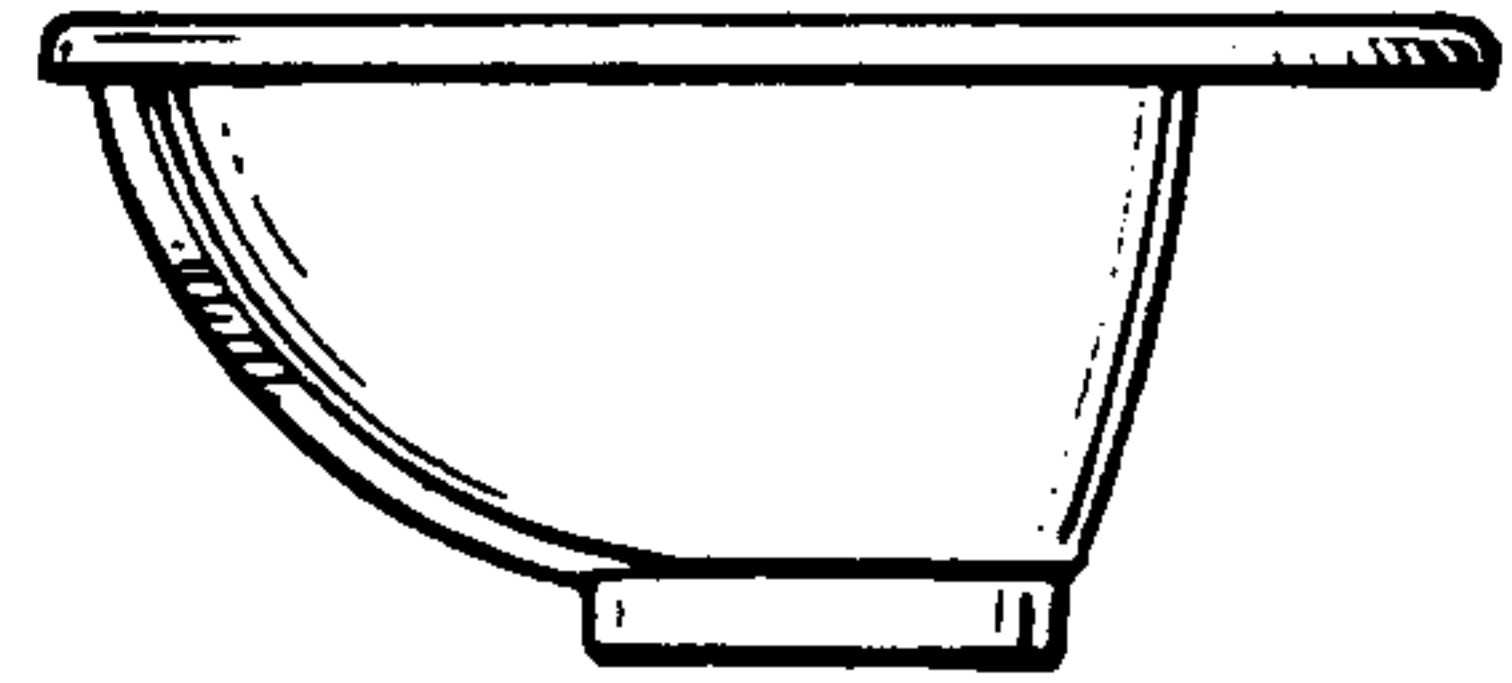
FIG. 1 is a right side elevational view of a lavatory showing my new design, the left side being a mirror image of the right side;  
 FIG. 2 is a top plan view thereof;  
 FIG. 3 is a front elevational view thereof;  
 FIG. 4 is a rear elevational view thereof;  
 FIG. 5 is a bottom plan view thereof; and  
 FIG. 6 is a cross sectional view taken on line VI—VI of FIG. 3.



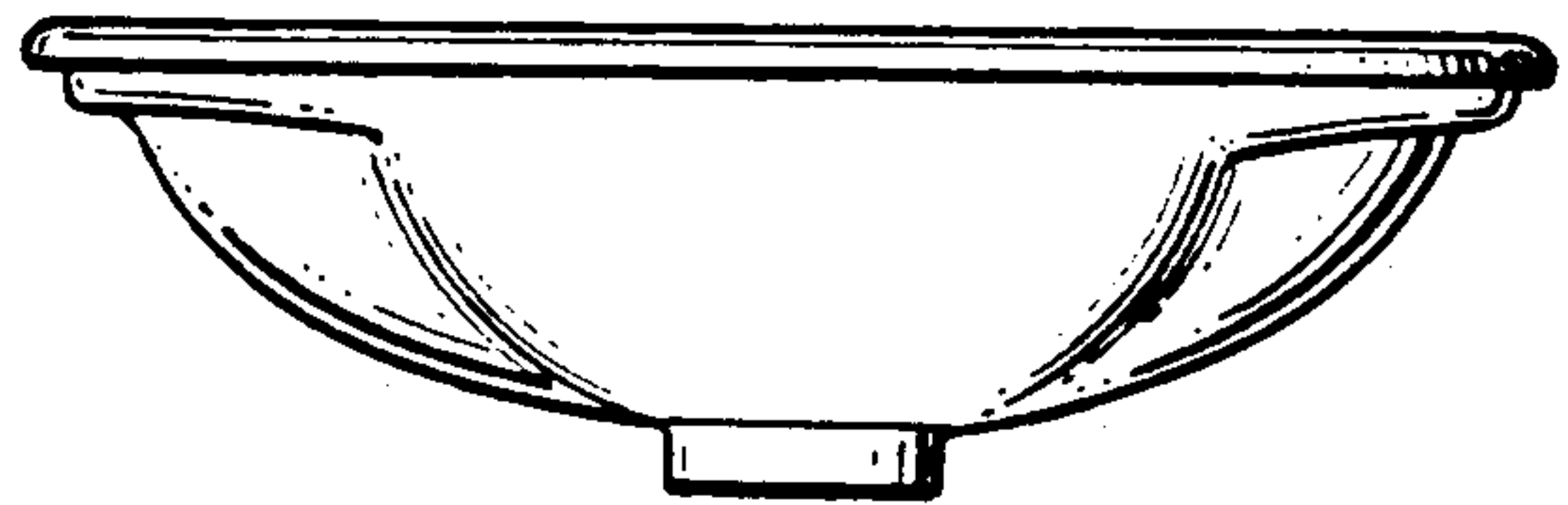
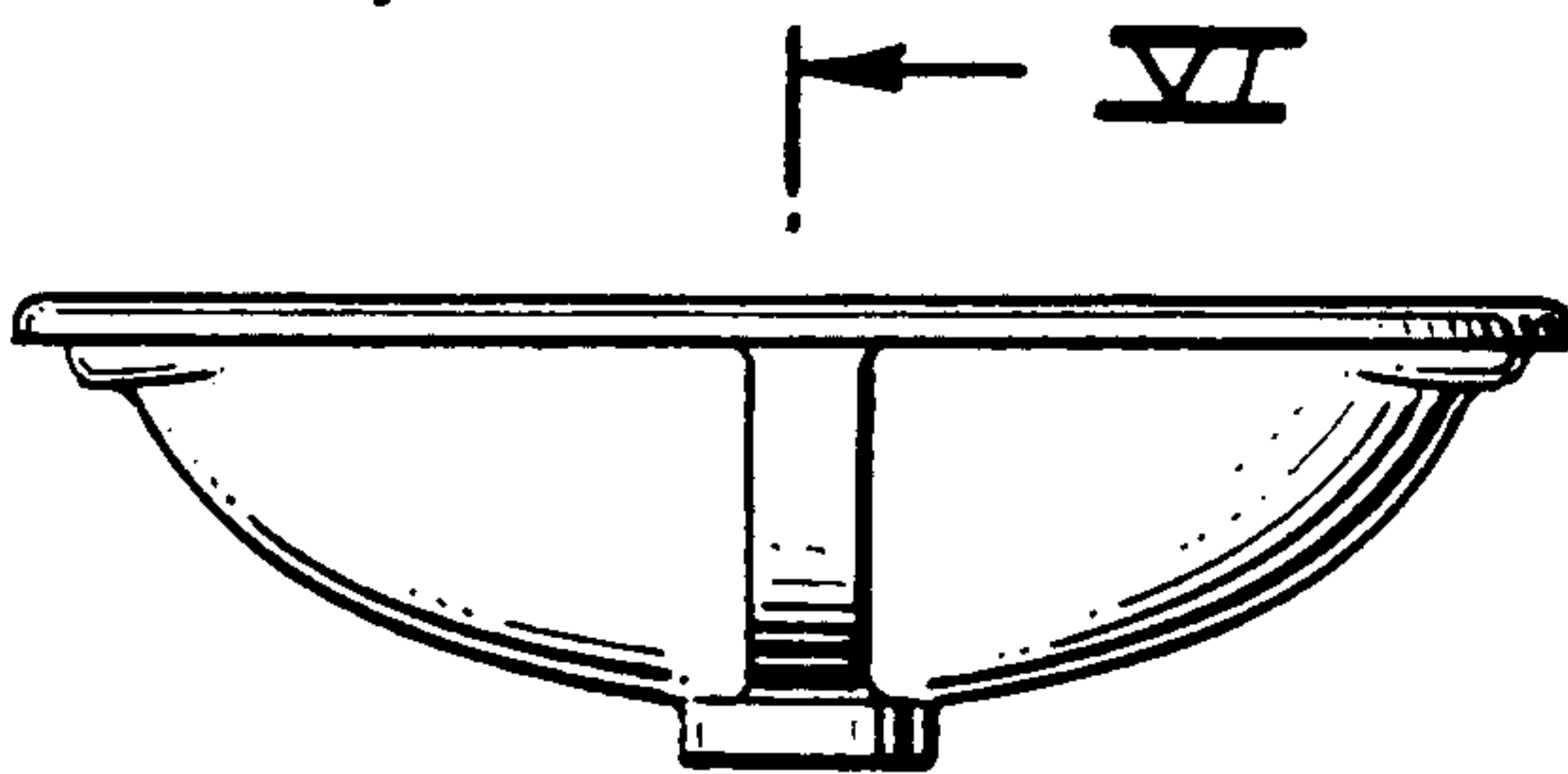
*Fig. 2.*



*Fig. 1.*

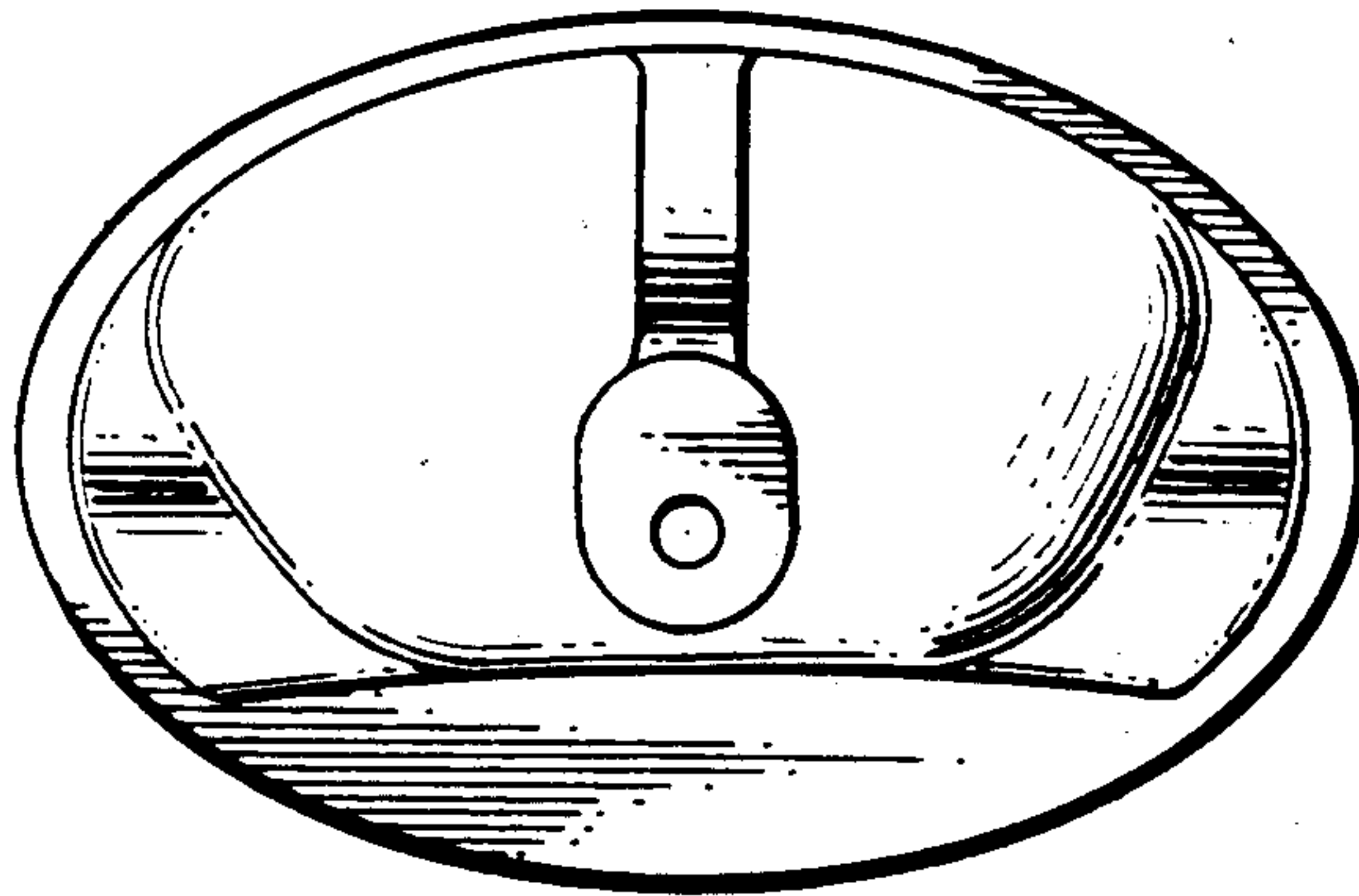


*Fig. 3.*



*Fig. 4.*

*Fig. 5.*



*Fig. 6.*

