

[54] BATHTUB

[75] Inventors: Rik Cuttriss, Fillmore; Scott Lenahan, Castaic, both of Calif.

[73] Assignee: Gruber Systems, Inc., Valencia, Calif.

[**] Term: 14 Years

[21] Appl. No.: 448,594

[22] Filed: Dec. 11, 1989

[52] U.S. Cl. D23/281

[58] Field of Search D23/270-283, D23/303-307; 4/513, 538-544, 584, 589, 590, 546, 559, 571-579

[56] References Cited

U.S. PATENT DOCUMENTS

- D. 250,830 1/1979 Clement D23/277
- D. 264,628 5/1982 Longmire D23/281 X

Primary Examiner—Susan J. Lucas
Attorney, Agent, or Firm—Poms, Smith, Lande & Rose

[57] CLAIM

The ornamental design for a bathtub, as shown and described.

DESCRIPTION

FIG. 1 is a side elevational view of a bathtub showing our new design, the opposite side being a mirror image;
 FIG. 2 is a top plan view thereof;
 FIG. 3 is a rear elevational view thereof, the front being a mirror image thereof;
 FIG. 4 is a bottom plan view thereof;
 FIG. 5 is a cross-sectional view thereof as taken along line V—V of FIG. 2;
 FIG. 6 is a cross-sectional view thereof as taken along line VI—VI of FIG. 5.
 The deck is shown in broken lines in FIGS. 5 and 6 for illustrative purposes only.

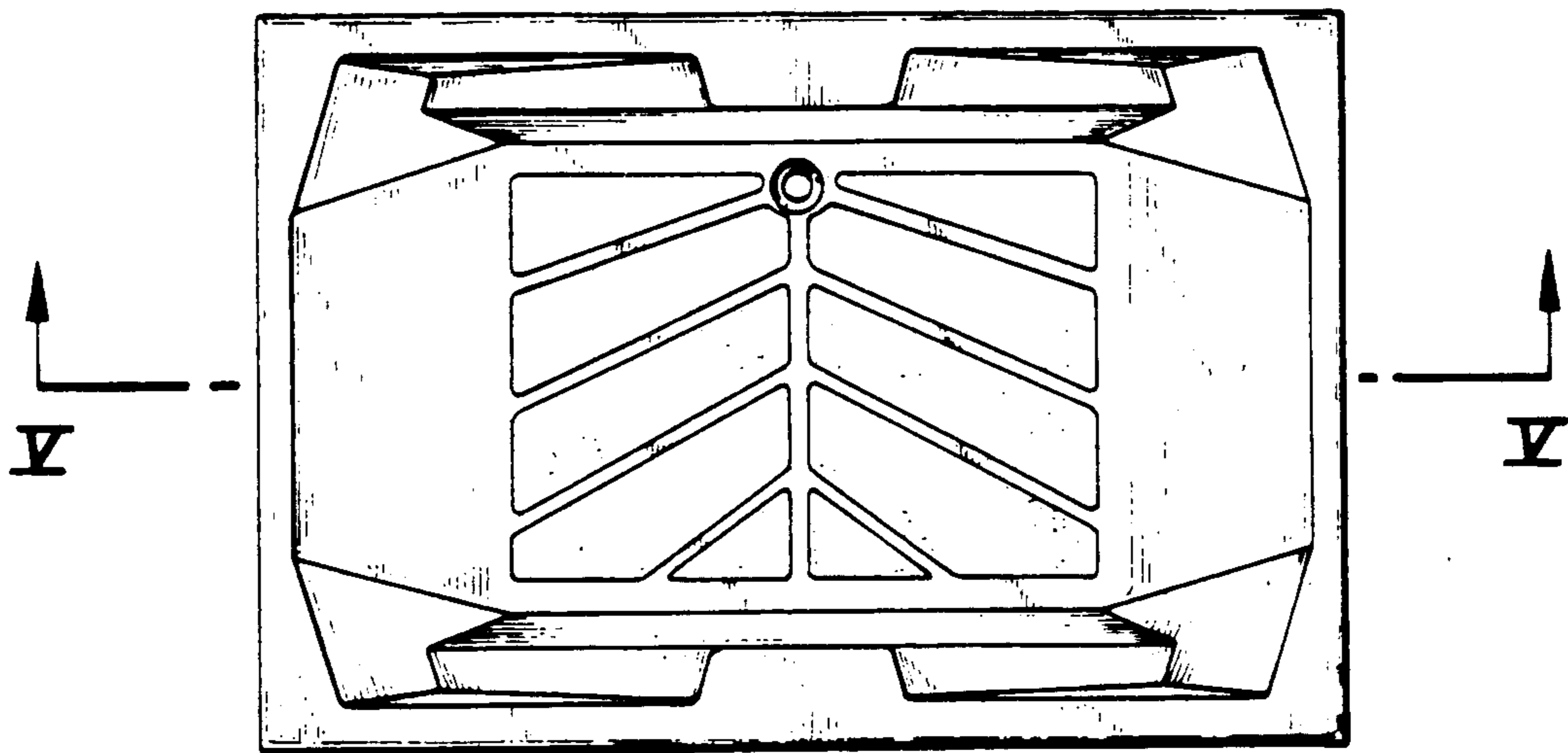

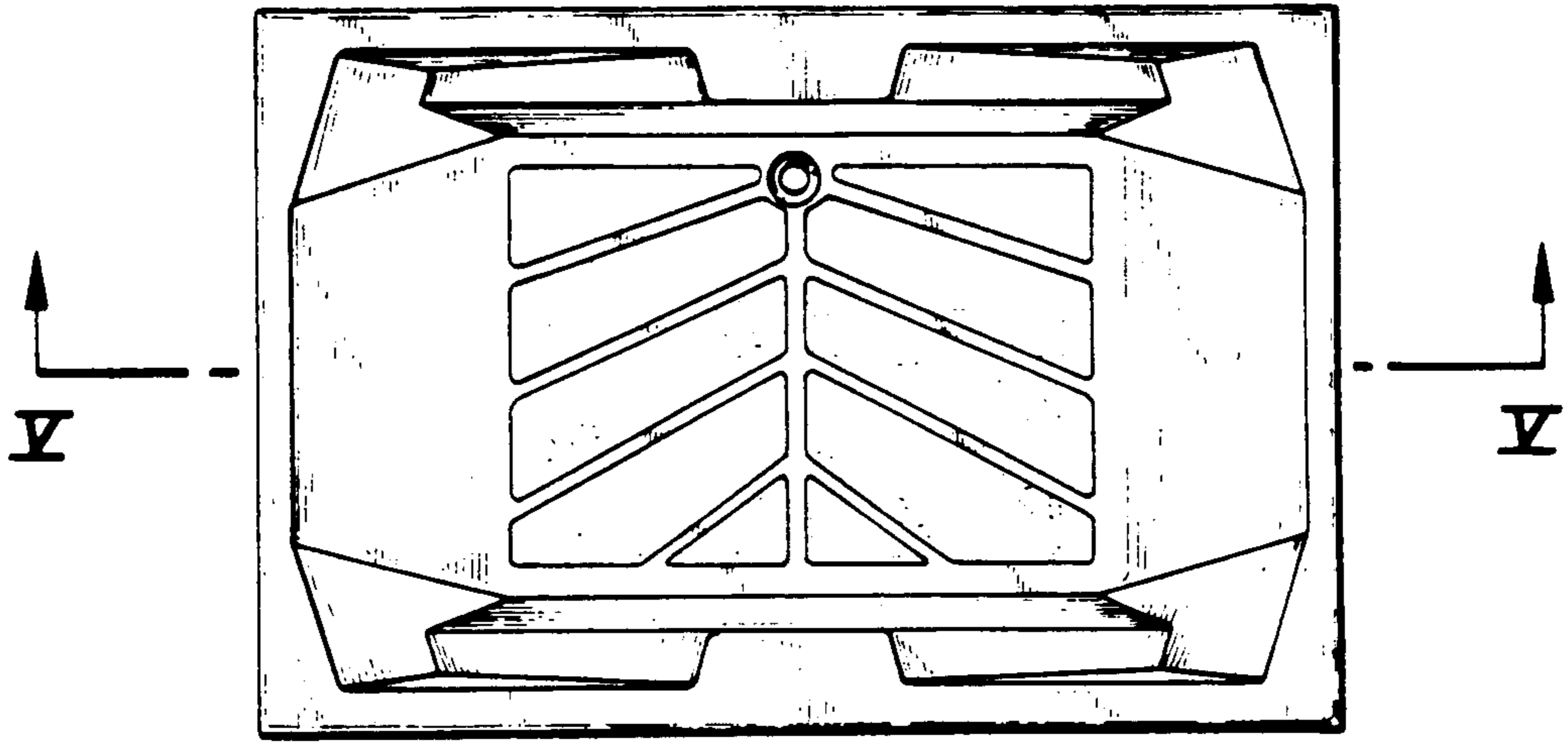

FIG. 2

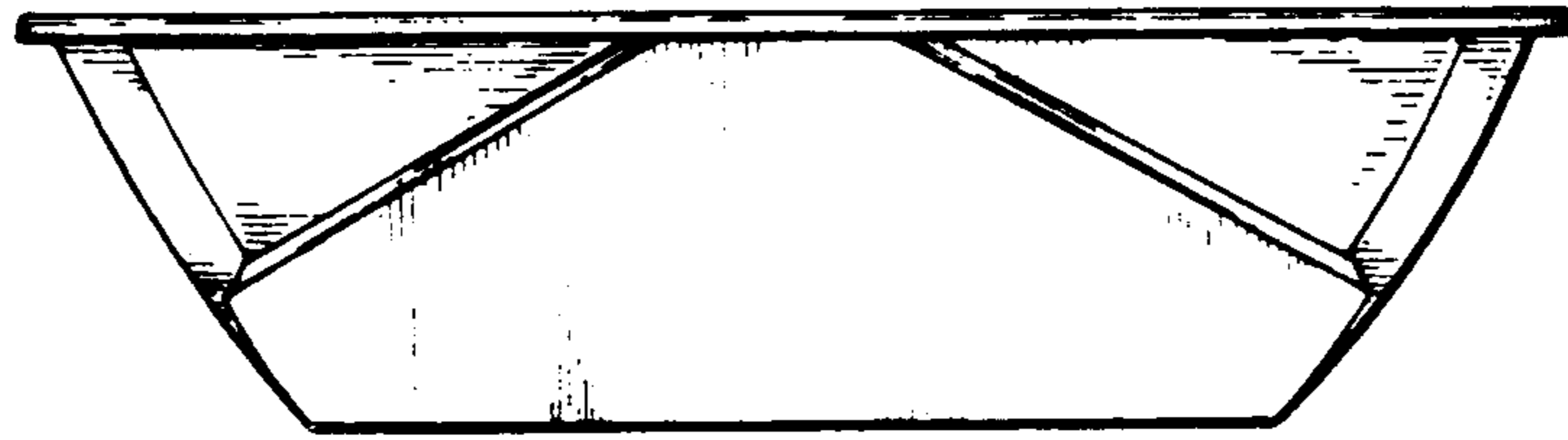

FIG. 1

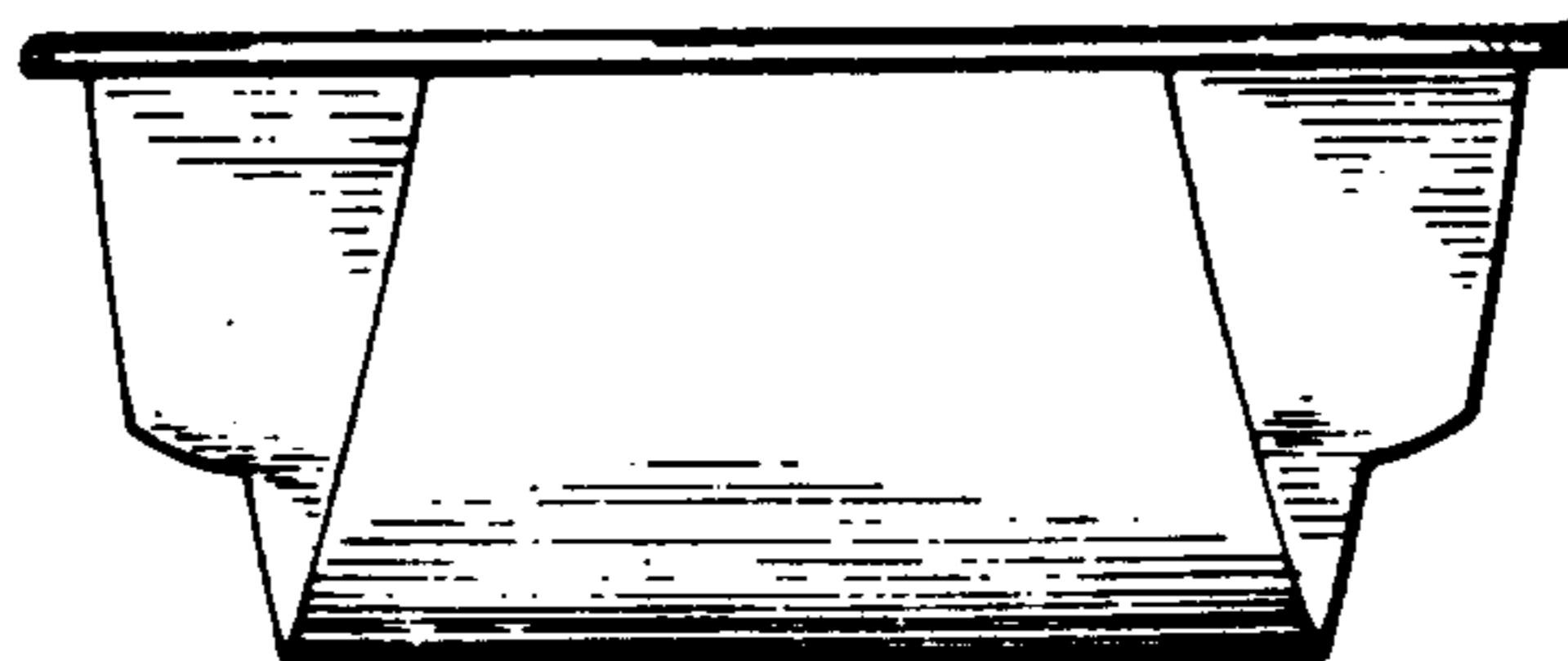

FIG. 3

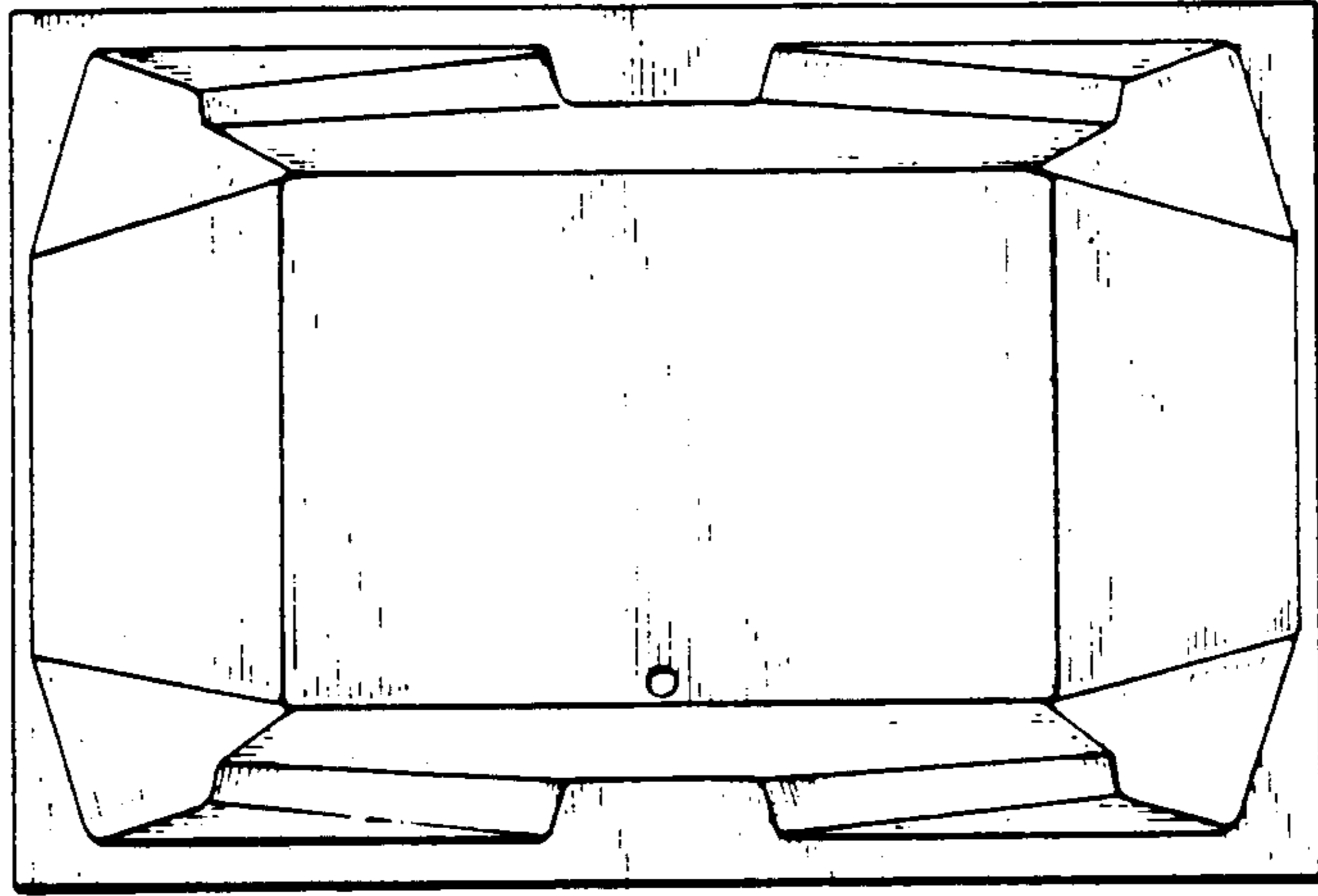

FIG. 4

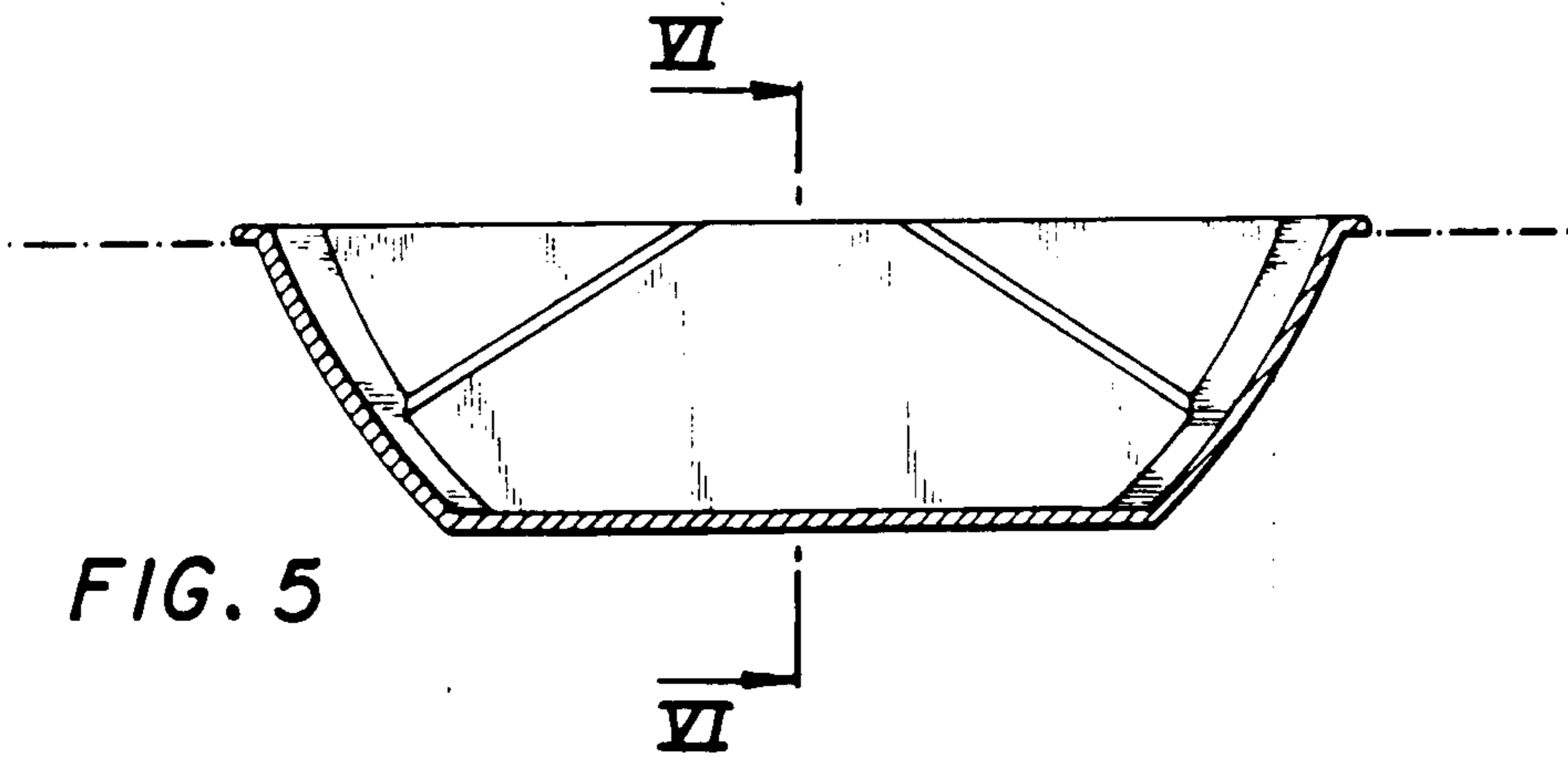

FIG. 5

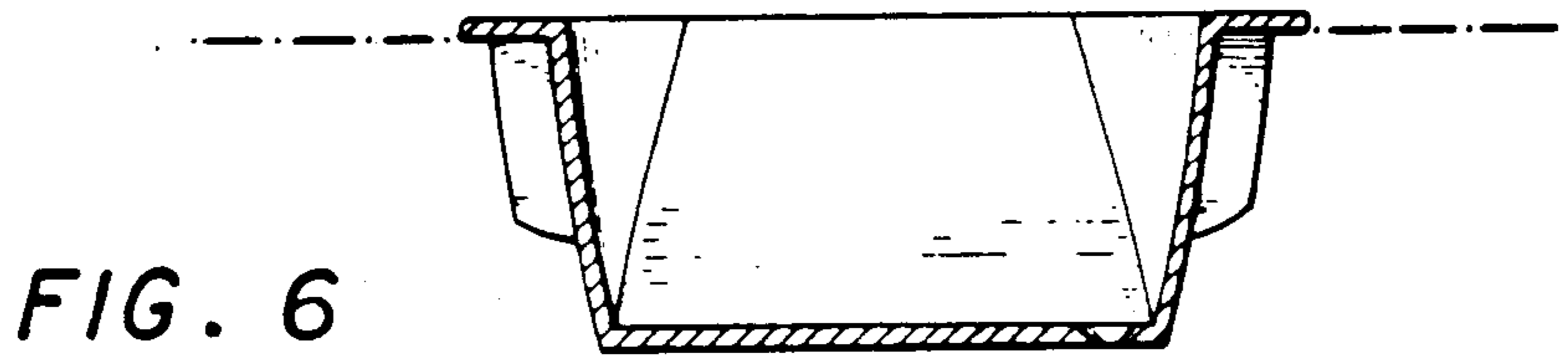

FIG. 6