

[54] CHAIR

[76] Inventor: Arne Samuelsson, Bergvägen 7, S-776 00 Hedemora, Sweden

[\*\*] Term: 14 Years

[21] Appl. No.: 208,004

[22] Filed: Jun. 16, 1988

[52] U.S. Cl. .... D6/366

[58] Field of Search ..... D6/334, 364, 365, 366, D6/367, 373, 500, 502

[56] References Cited

U.S. PATENT DOCUMENTS

D. 166,192	3/1952	Hamilton	.....	D6/366
D. 194,458	1/1963	Pearson	.....	D6/366
D. 233,807	12/1974	Ruf	.....	D6/366
D. 239,988	5/1976	Dittert	.....	D6/366
D. 273,917	5/1984	Pelly et al.	.....	D6/366

Primary Examiner—Bruce W. Dunkins

Assistant Examiner—Gary D. Watson  
Attorney, Agent, or Firm—Ostrolenk, Faber, Gerb & Soffen

[57] CLAIM

The ornamental design for a chair, as shown and described.

DESCRIPTION

FIG. 1 is a front perspective view of a chair showing my new design;  
FIG. 2 is a rear perspective view taken from below;  
FIG. 3 is a rear perspective view;  
FIG. 4 is a front perspective view;  
FIG. 5 is a bottom plan view;  
FIG. 6 is a side perspective view;  
FIG. 7 is a perspective view showing the side opposite that shown in FIG. 6; and  
FIG. 8 is a top plan view thereof.  
FIGS. 2-8 have been drawn on an enlarged scale with respect to FIGS. 1 and 2.

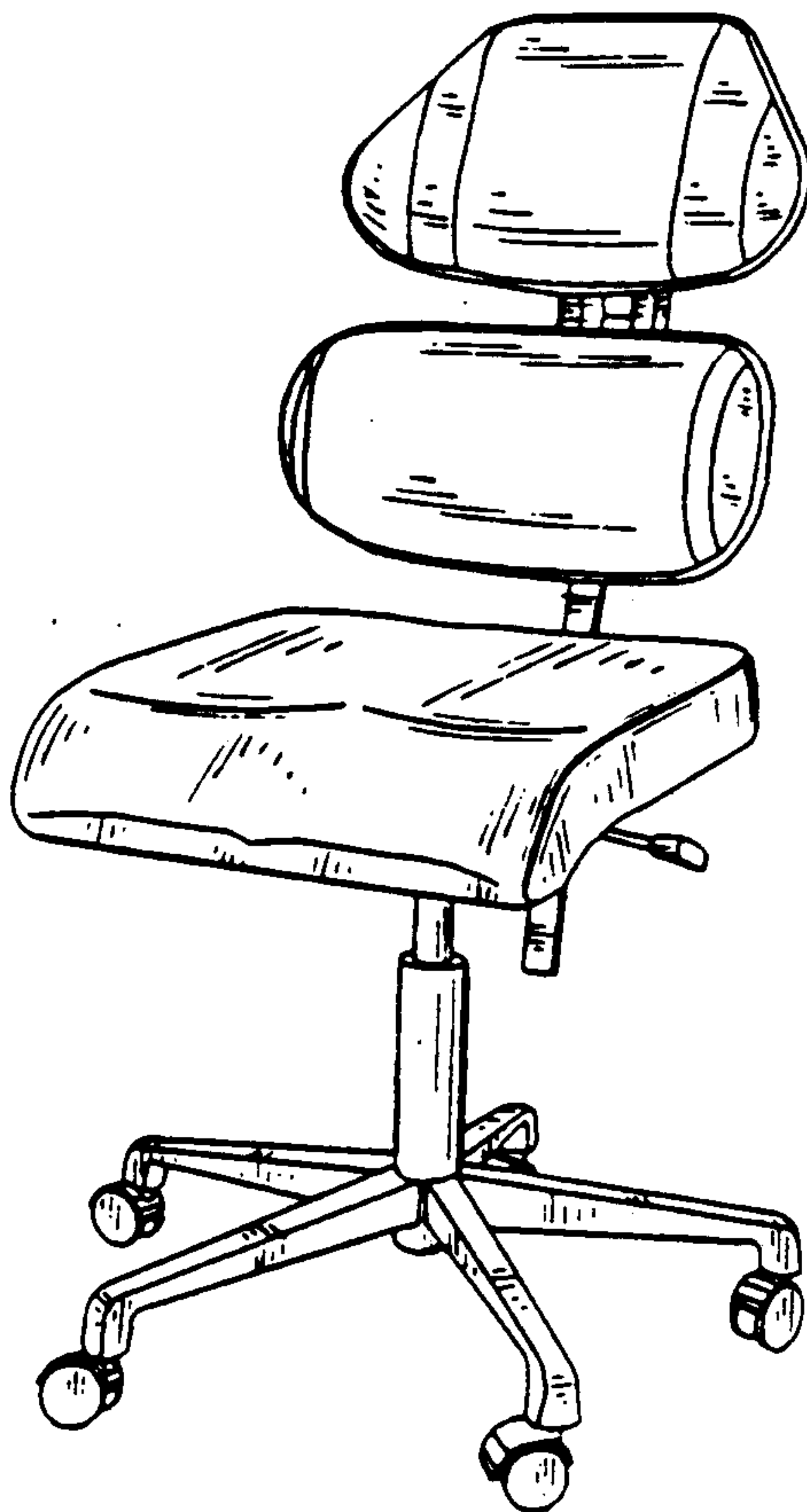

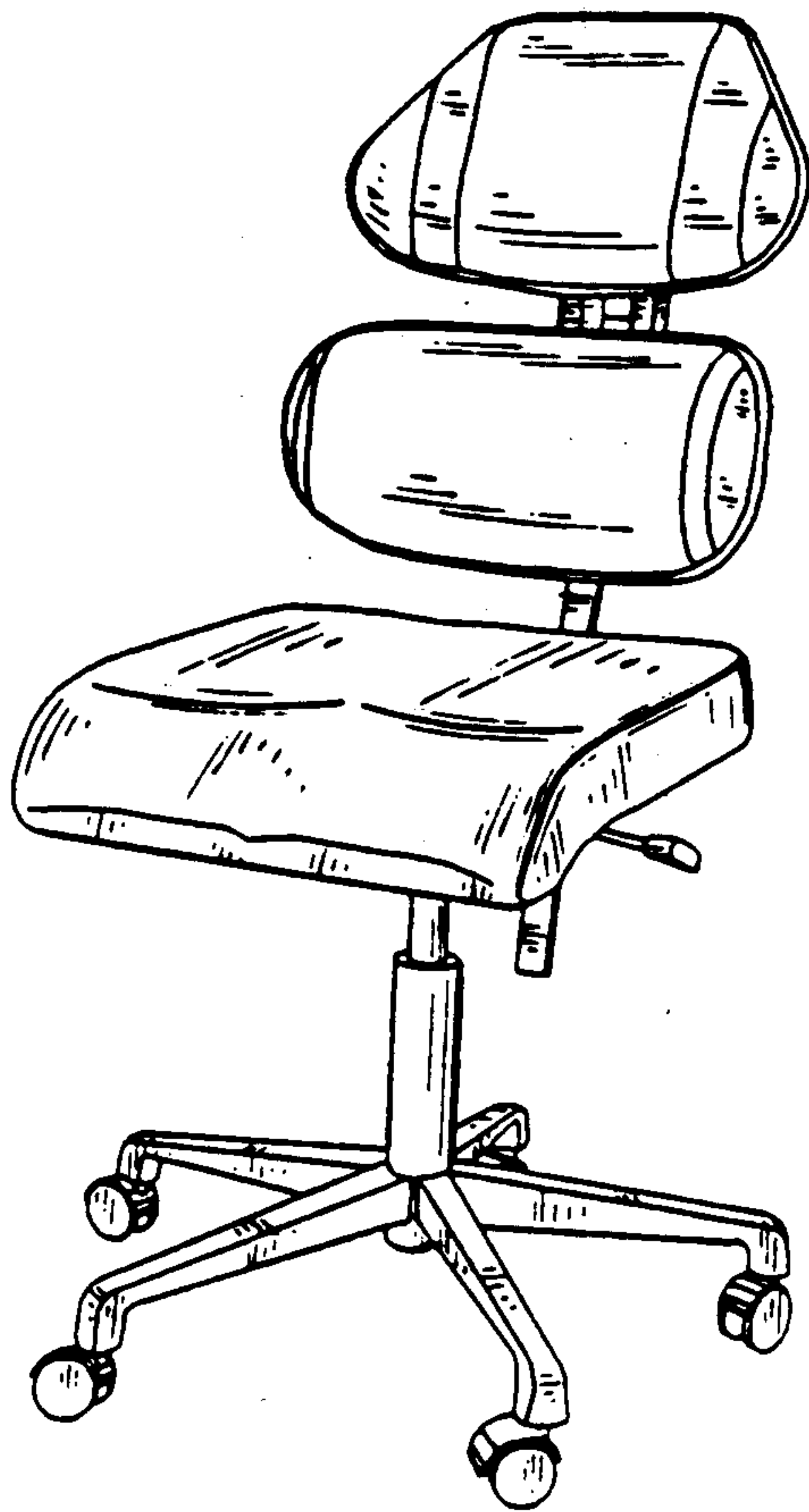

Fig. 1

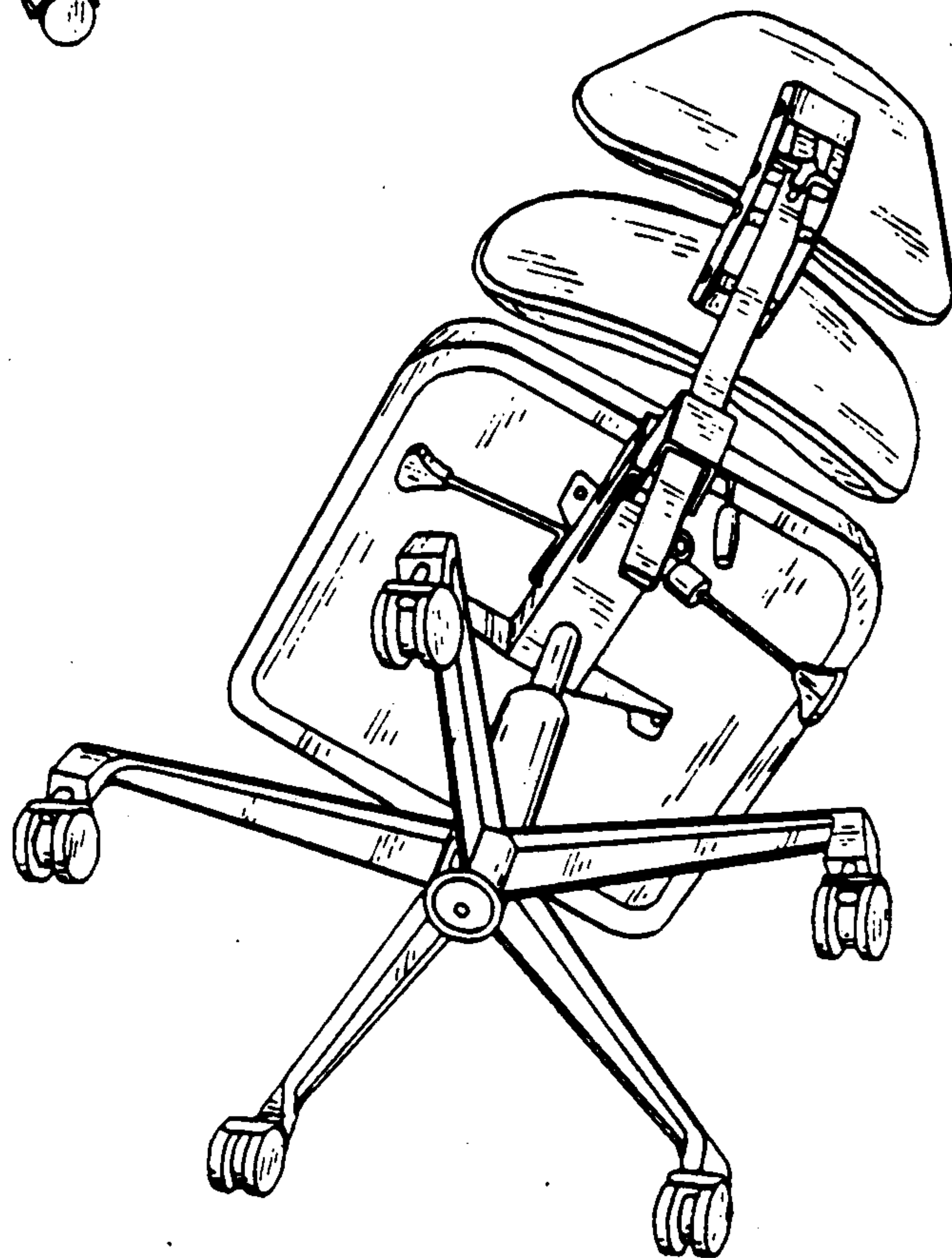

Fig. 2

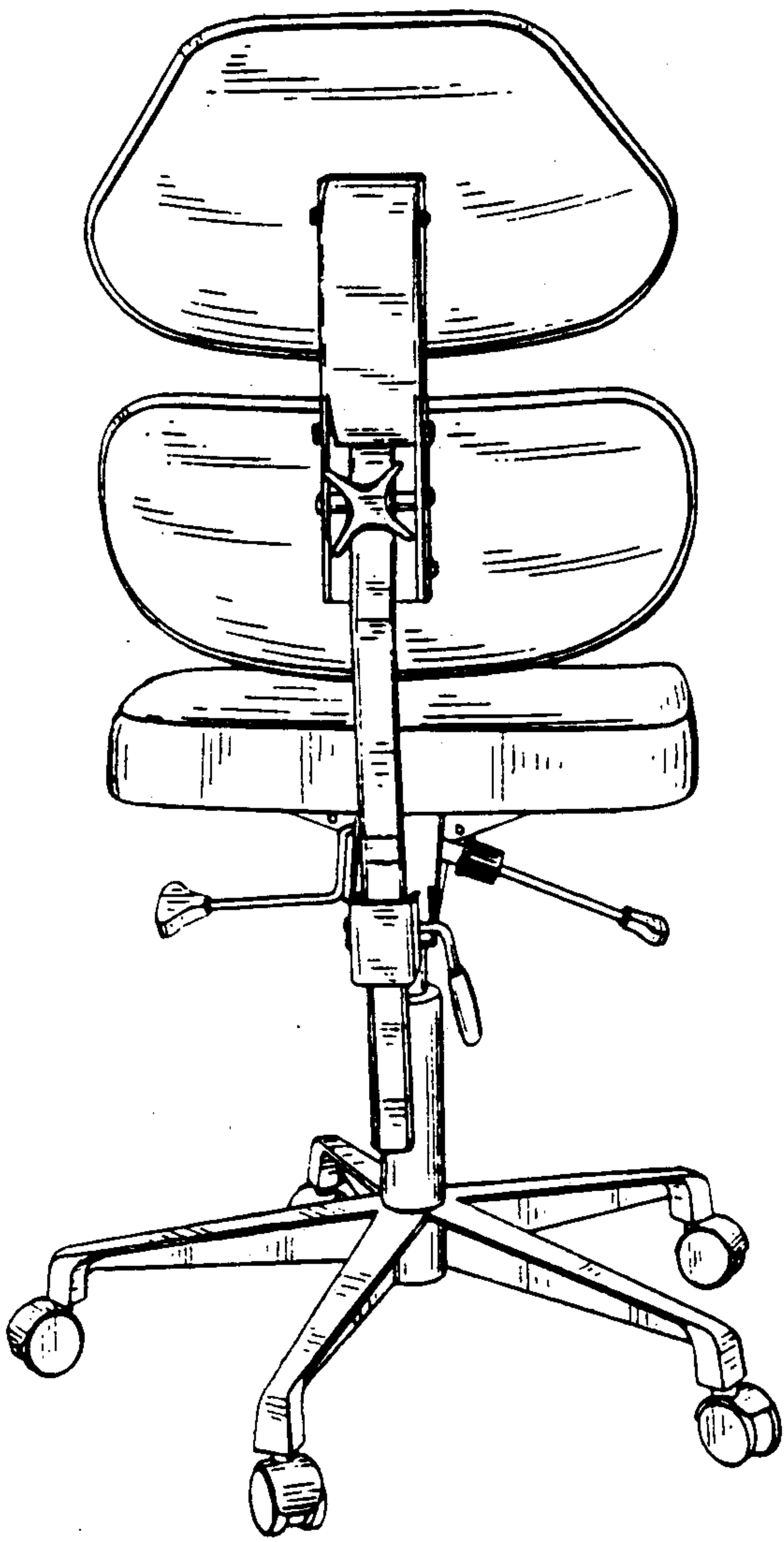

Fig. 3

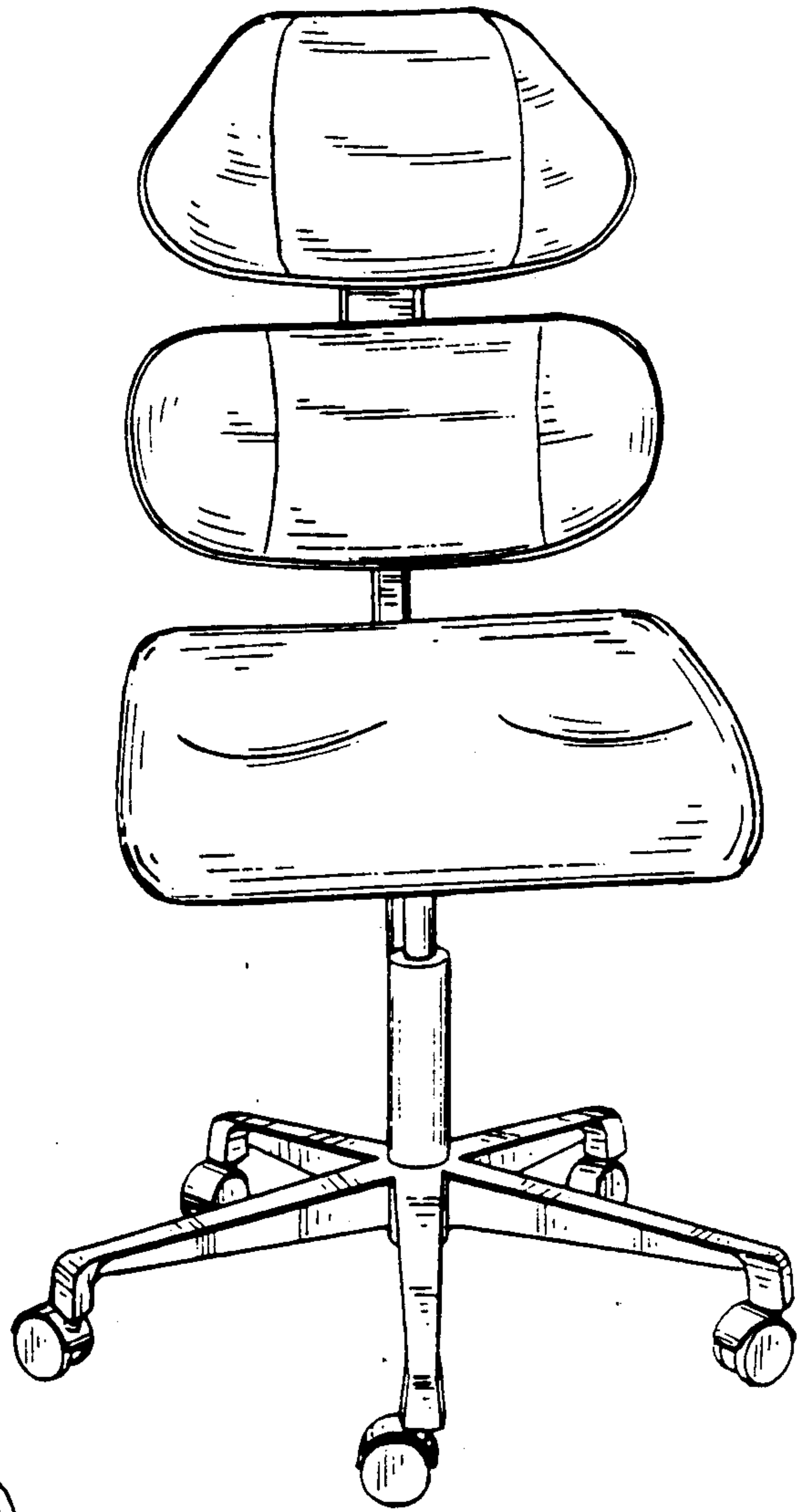

Fig. 4

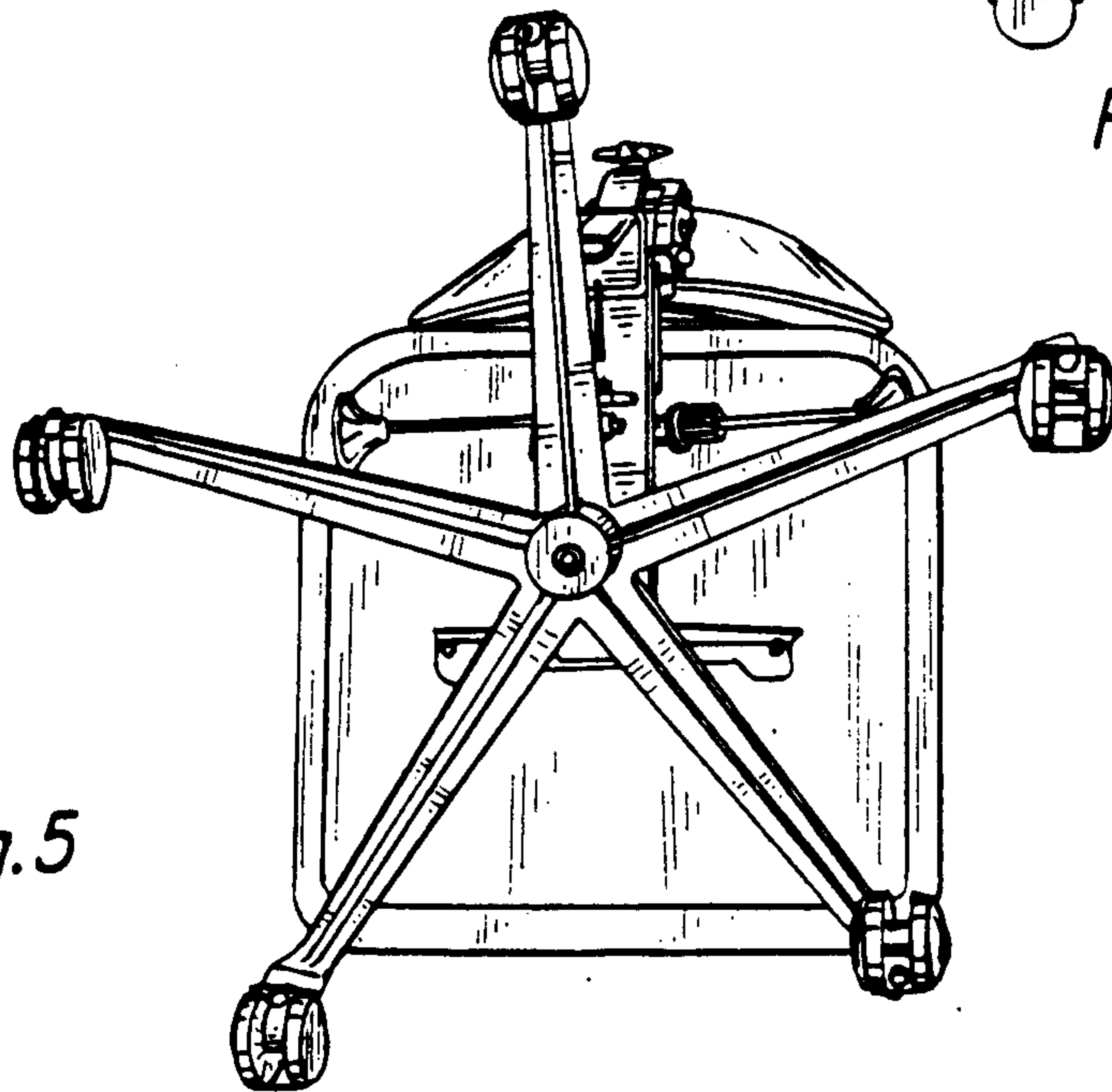
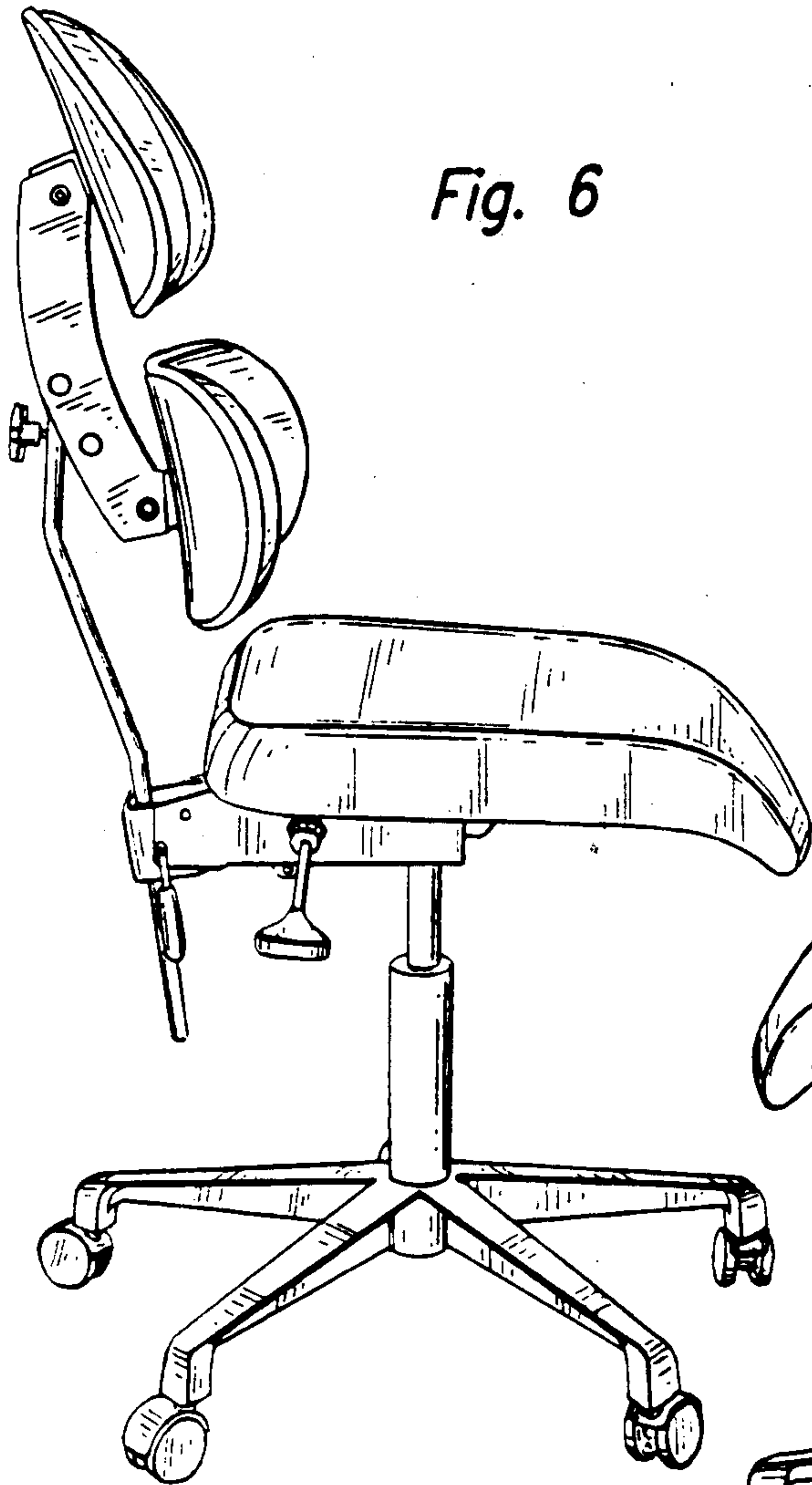
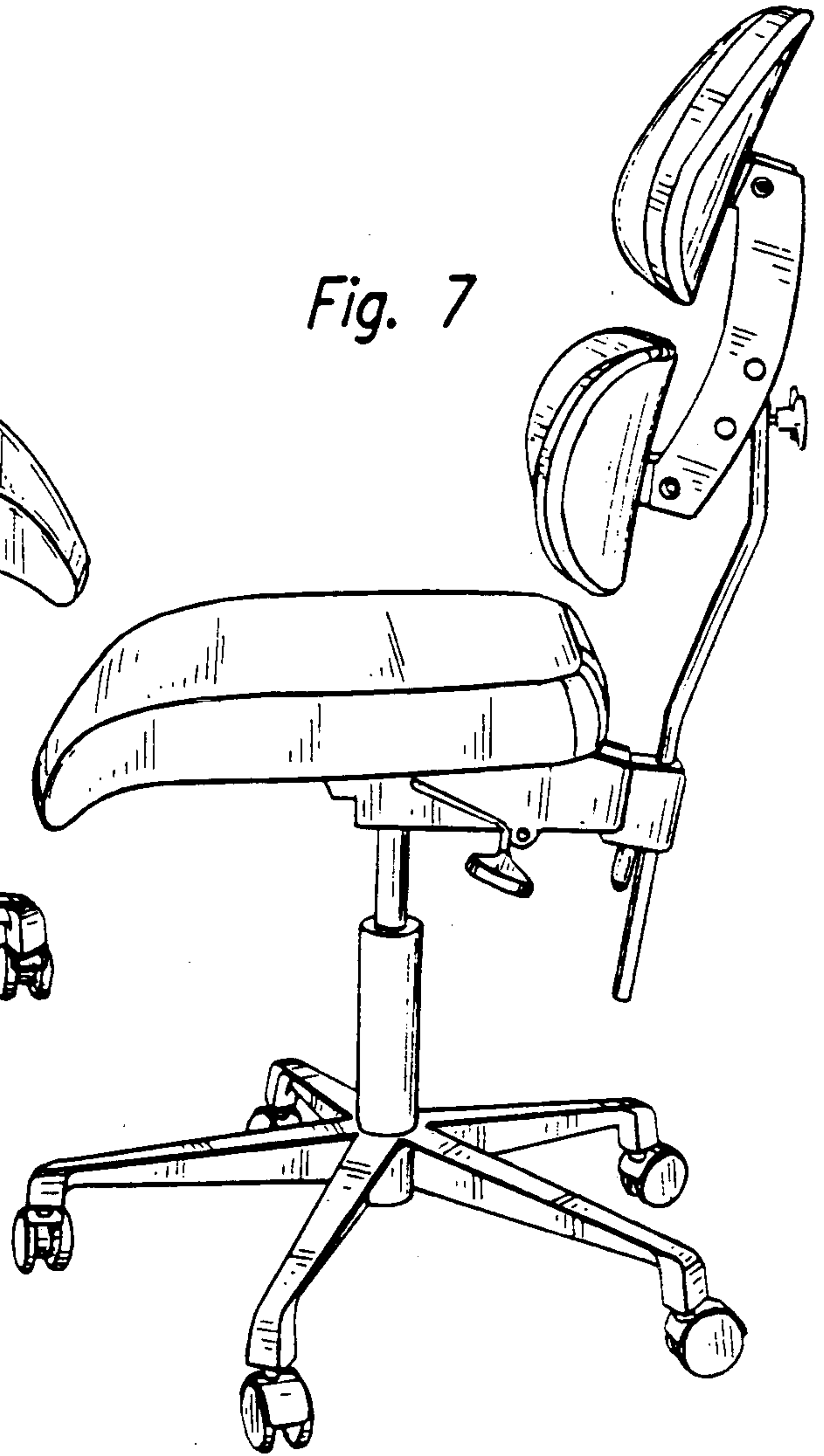

Fig. 5

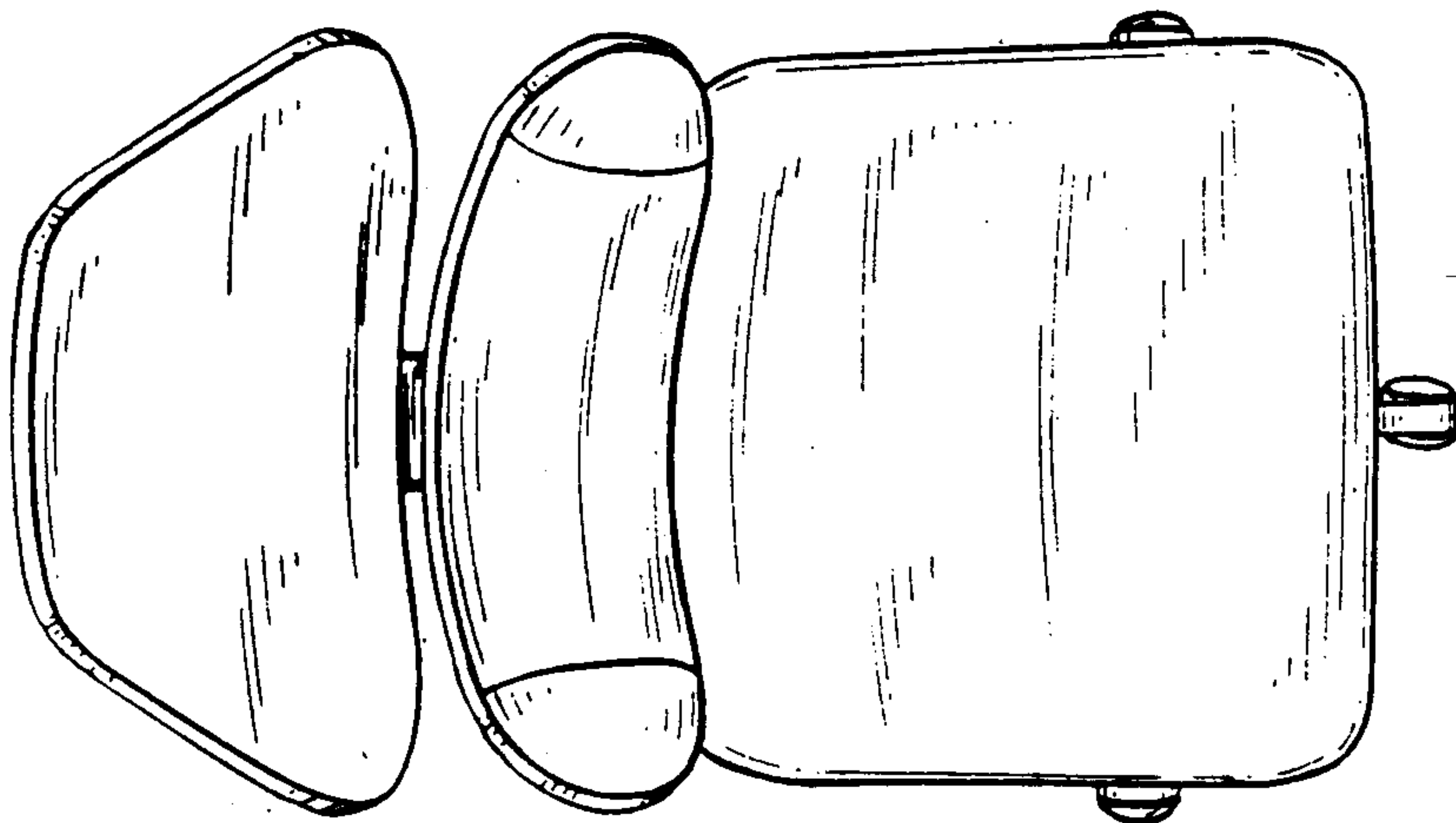



*Fig. 6*



*Fig. 7*



*Fig. 8*