

[54] WEB DRYING SECTION

[75] Inventors: Borgeir Skaugen; Gregory L. Wedel, both of Beloit, Wis.

[73] Assignee: Beloit Corporation, Beloit, Wis.

[**] Term: 14 Years

[21] Appl. No.: 540,420

[22] Filed: Jun. 19, 1990

Related U.S. Application Data

[62] Division of Ser. No. 14,569, Feb. 13, 1987.

[52] U.S. Cl. D34/28

[58] Field of Search 34/16, 23, 113, 114, 34/115, 116, 85; 162/290; D34/28

[56] References Cited

U.S. PATENT DOCUMENTS

409,615	8/1889	Palmer	34/85
3,263,344	8/1966	Stickle	34/116
4,000,035	12/1976	Schiel	162/290
4,183,148	1/1980	Koski et al.	34/23
4,202,113	5/1980	Kankaanpaa	34/23
4,359,827	11/1982	Thomas	34/16
4,441,263	4/1984	Vedenpää34	115/
4,483,083	11/1984	Chance	34/113
4,625,430	12/1986	Aula et al.	34/113
4,625,434	12/1986	Karlsson	34/114
4,654,981	4/1987	Grebe et al.	34/114

Primary Examiner—Wallace R. Burke

Assistant Examiner—H. Baynham

Attorney, Agent, or Firm—Dirk J. Veneman; Raymond W. Campbell; David J. Archer

[57] CLAIM

The ornamental design for a web drying section, as shown and described.

DESCRIPTION

FIG. 1 is a front elevational view of a web drying section showing my new design;

FIG. 2 is a bottom plan view thereof;

FIG. 3 is a top plan view thereof;

FIG. 4 is a front elevational view of a second embodiment of the design shown in FIG. 1;

FIG. 5 is a top plan view thereof;

FIG. 6 is a bottom plan view thereof;

FIG. 7 is a left side elevational view of the first embodiment;

FIG. 8 is a right side elevational view thereof;

FIG. 9 is a rear elevational view thereof;

FIG. 10 is a perspective view thereof;

FIG. 11 is a left side elevational view of the second embodiment;

FIG. 12 is a right side elevational view thereof;

FIG. 13 is a rear elevational view thereof; and

FIG. 14 is a perspective view thereof.

In a papermachine dryer section, a plurality of dryer rolls at equal elevation are provided for drying a first side of a web, followed by a plurality of dryer rolls, each at a second elevation, for drying a second side of the web.

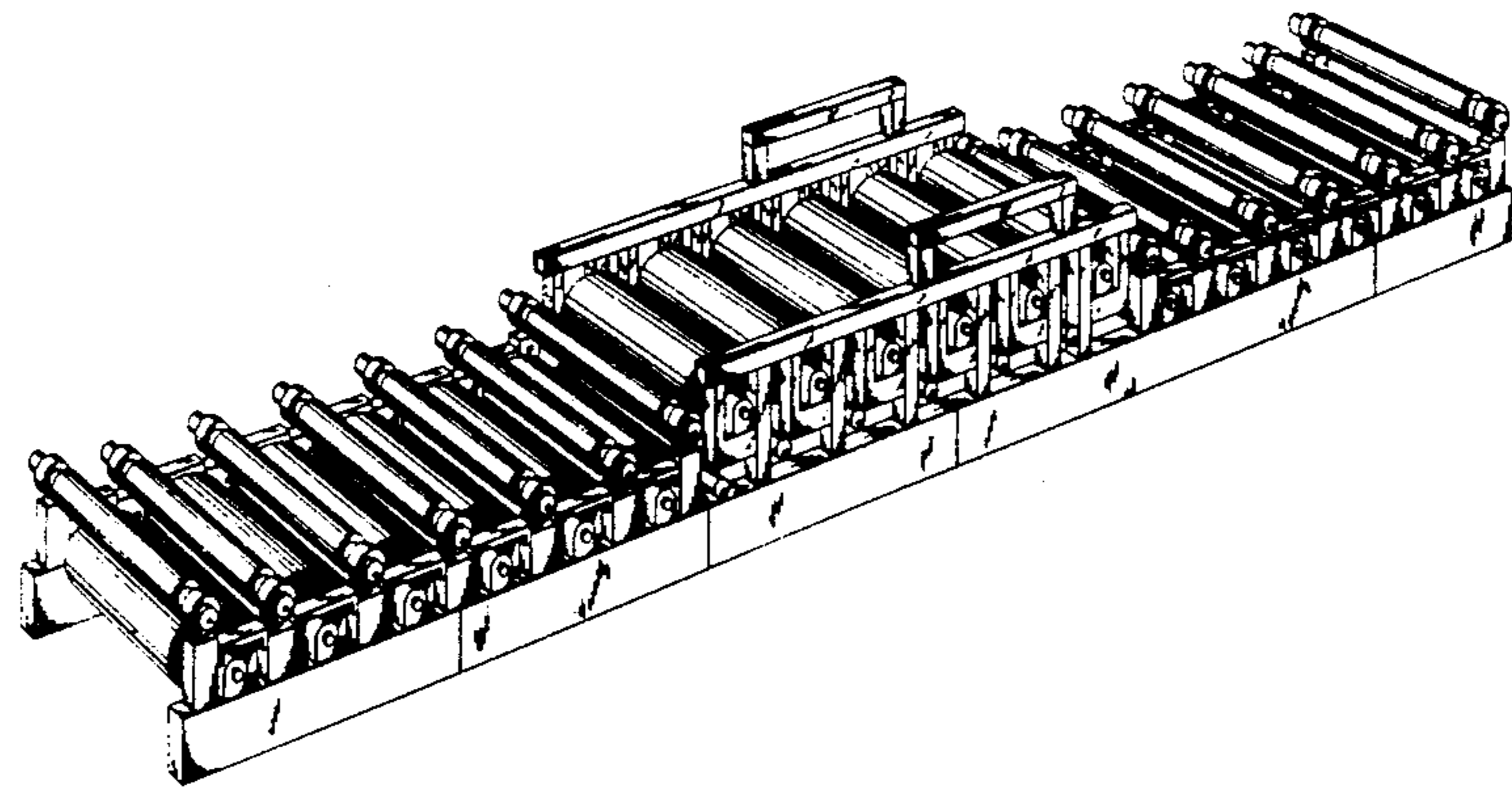
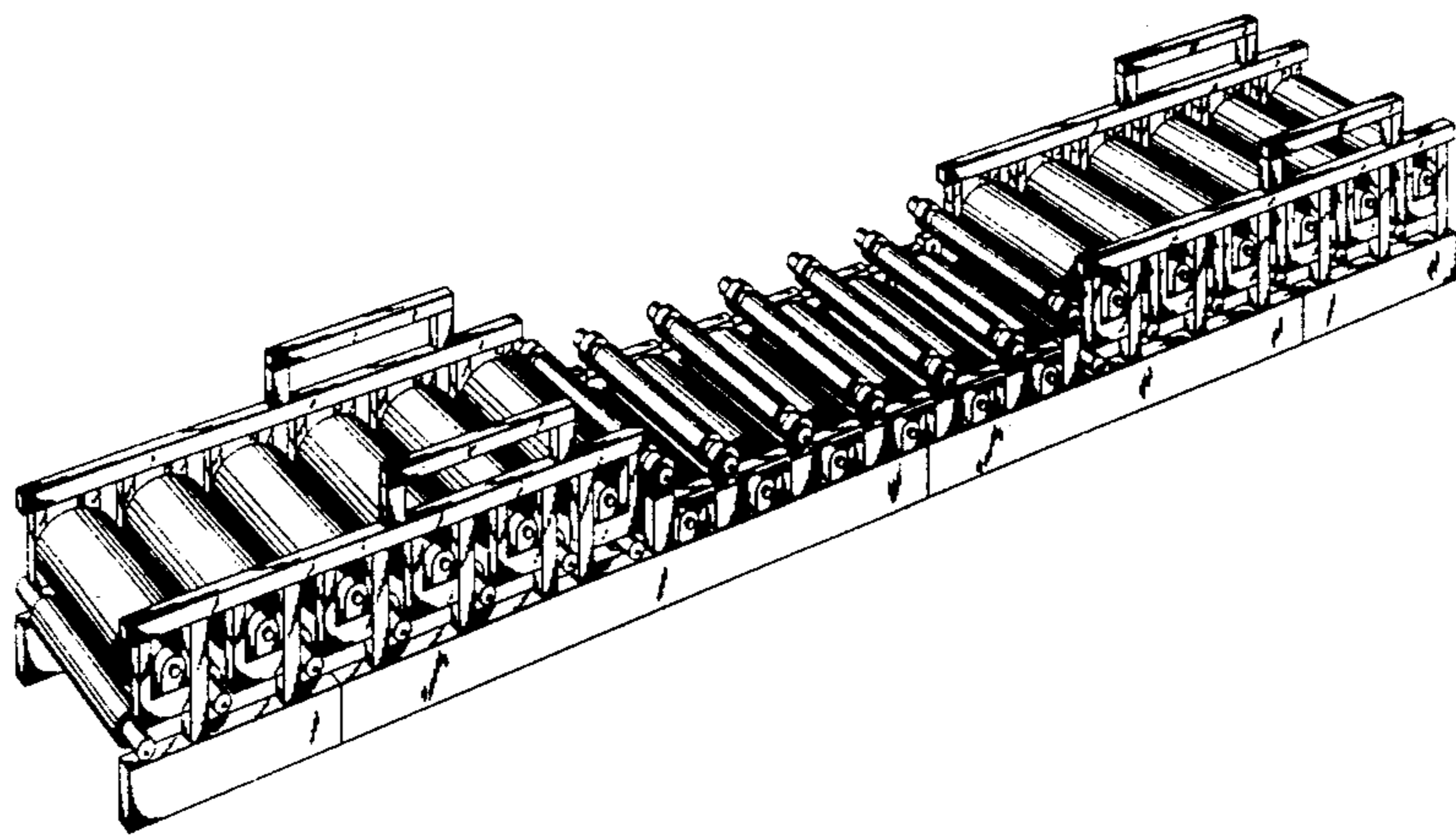

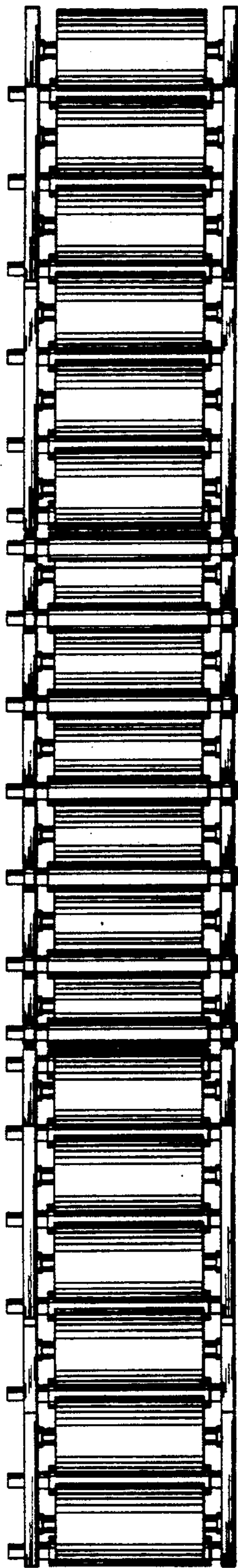

Fig. 3

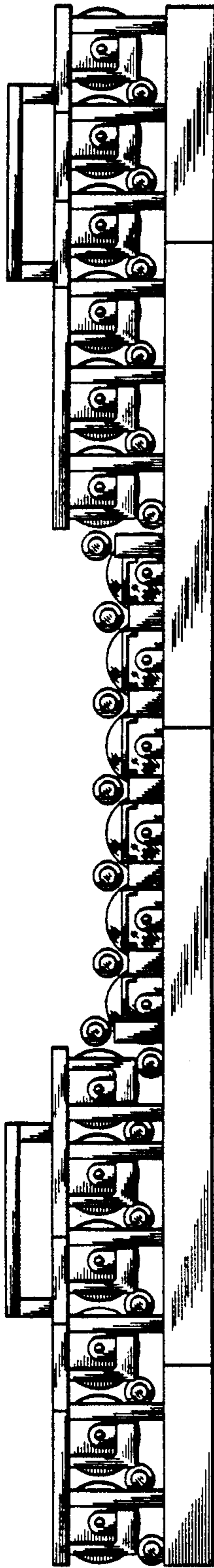

Fig. 1

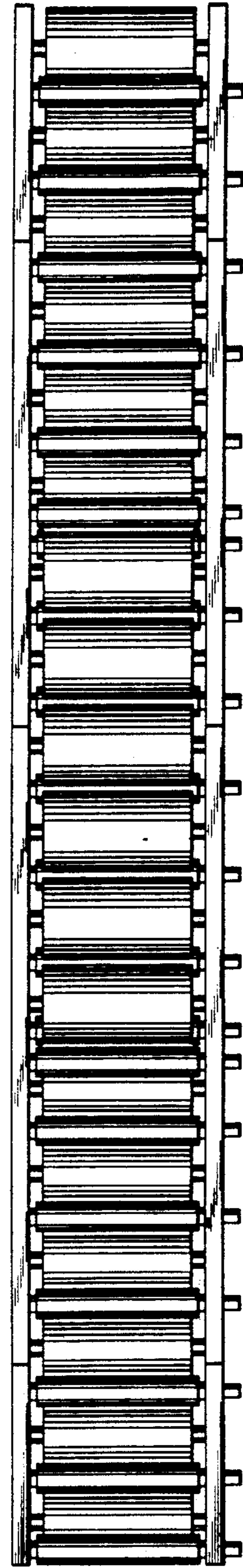

Fig. 2

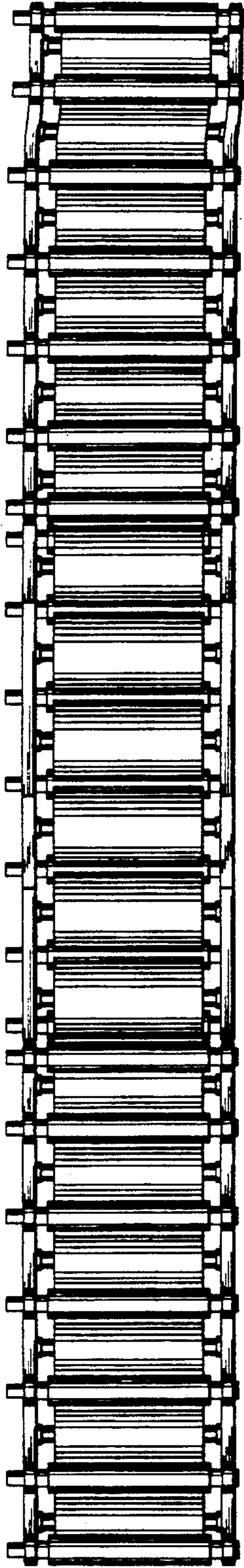

Fig. 5

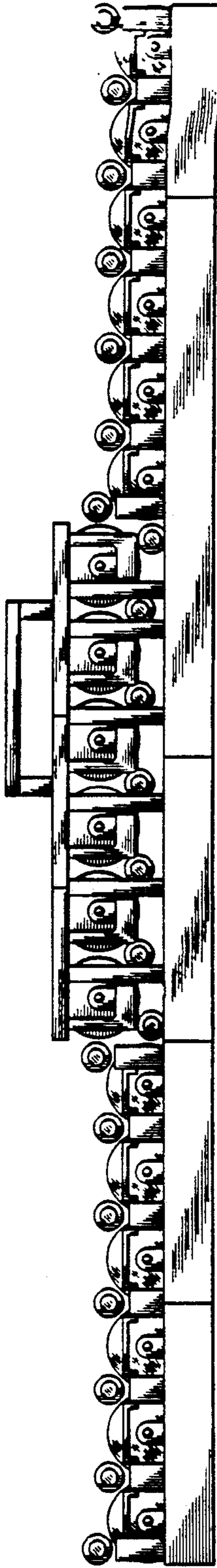

Fig. 4

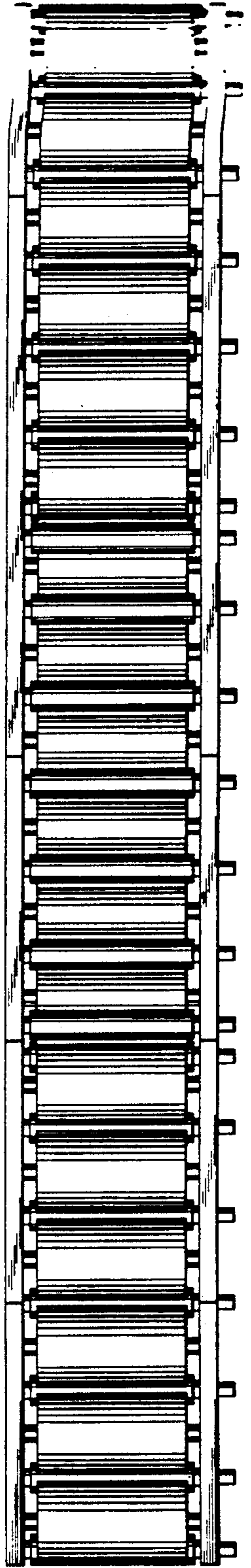

Fig. 6

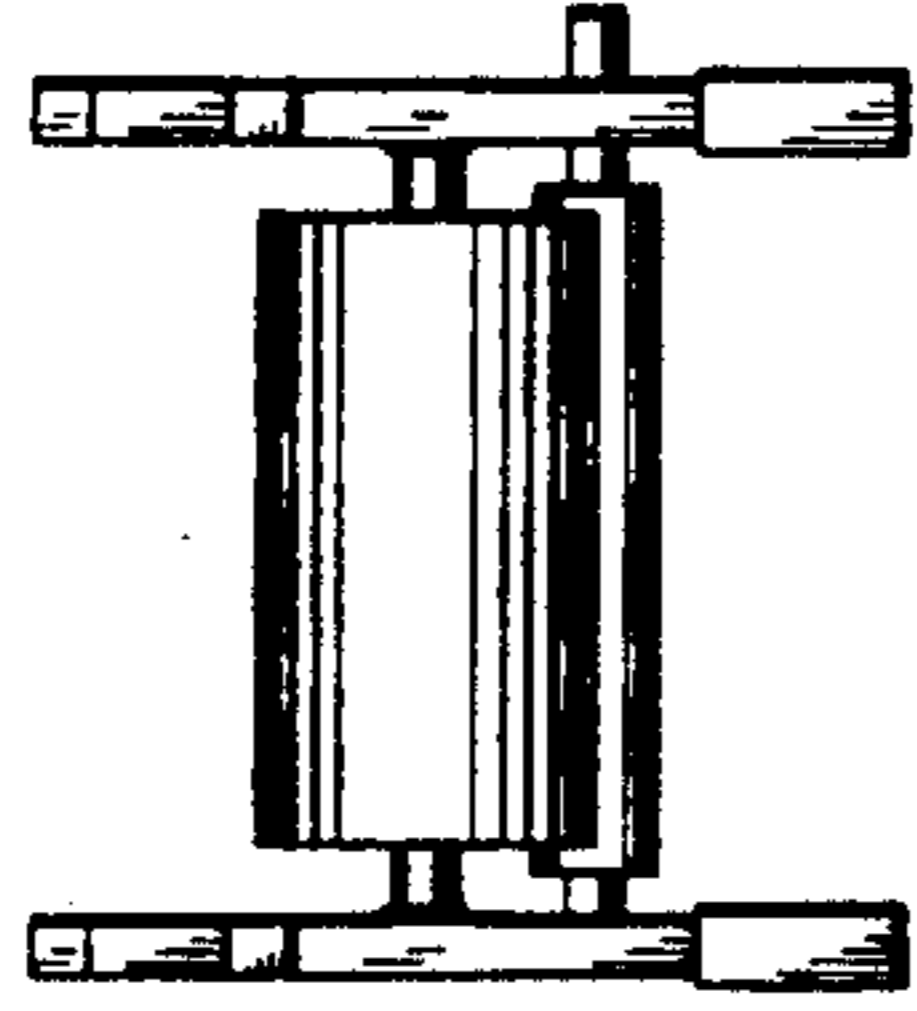

Fig. 8

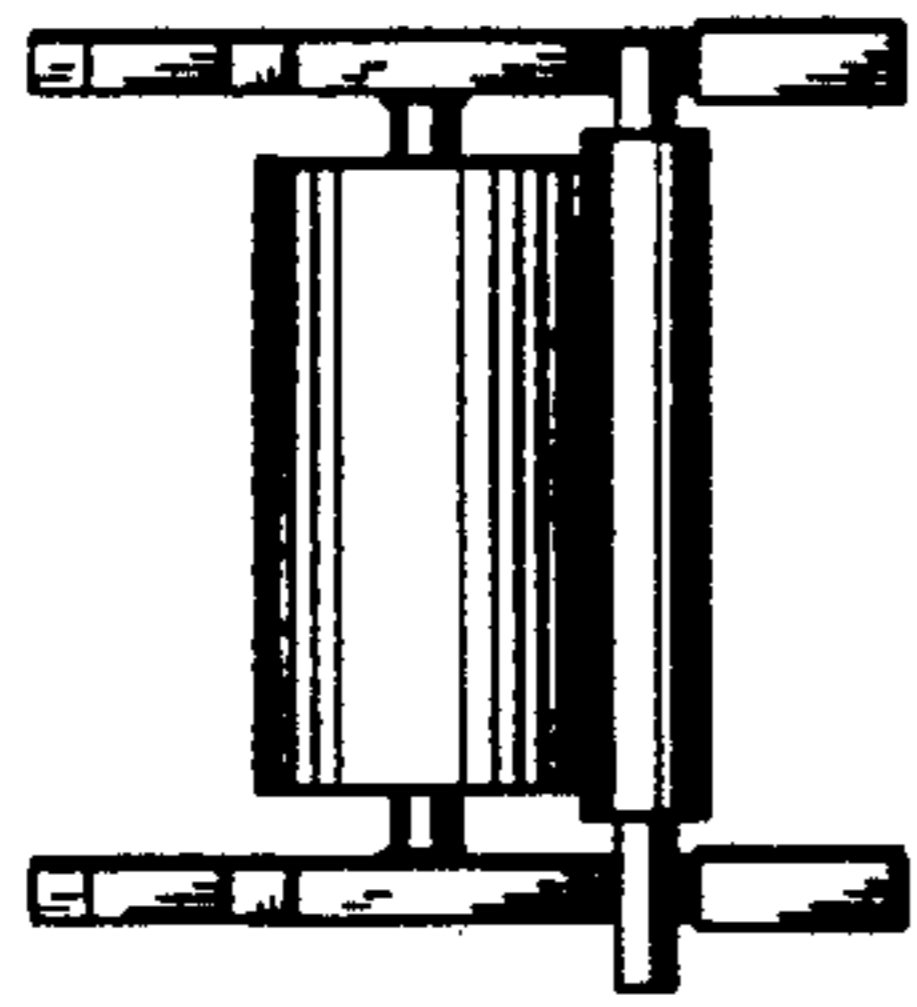

Fig. 7

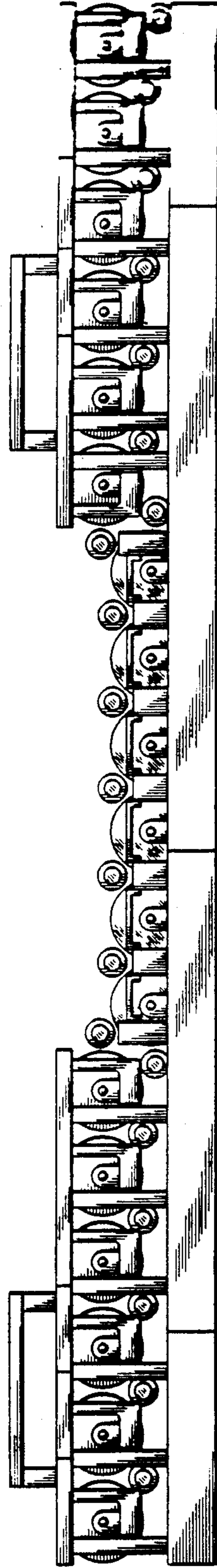

Fig. 9

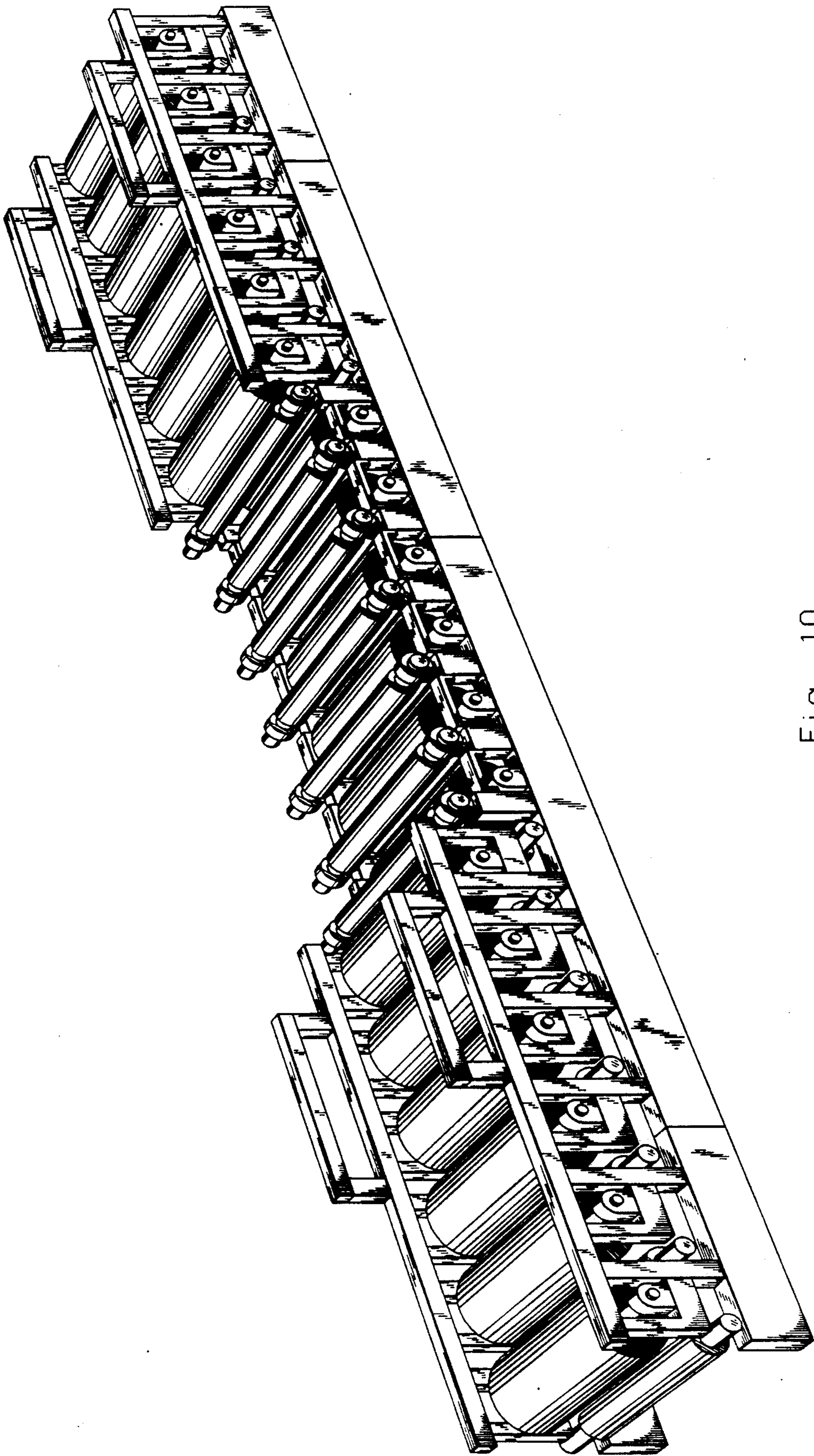

Fig. 10

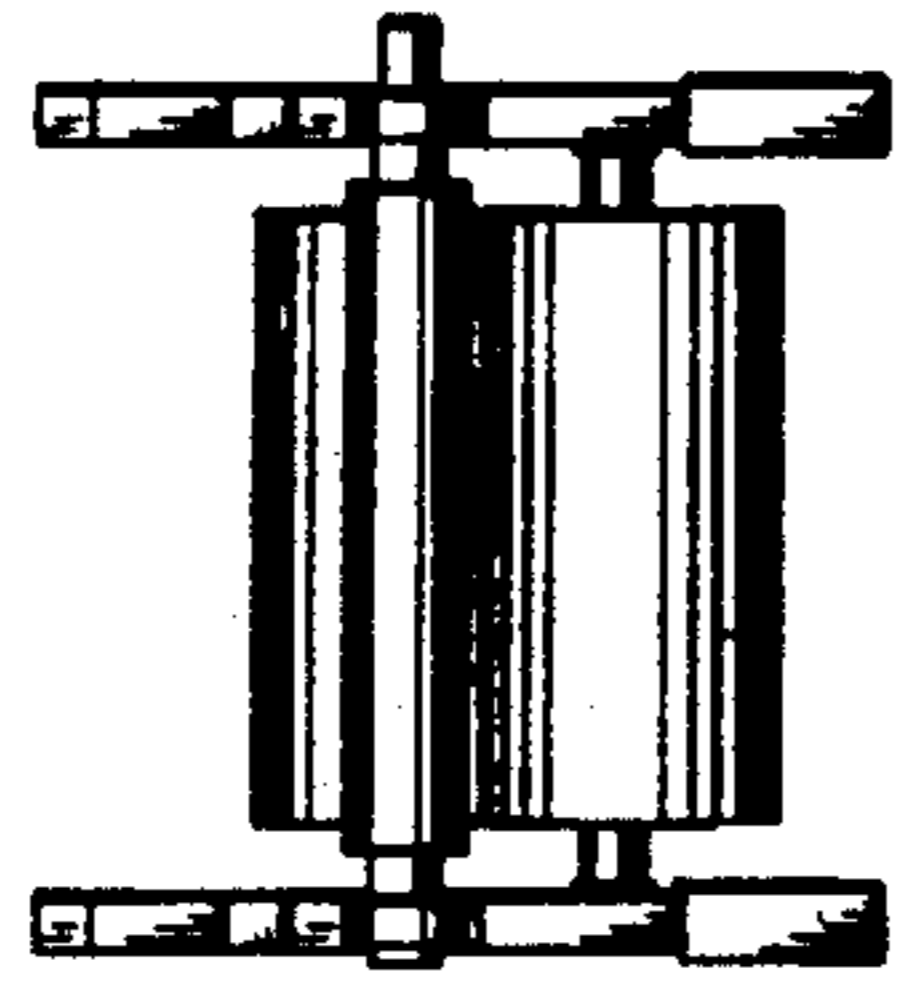

Fig. 12

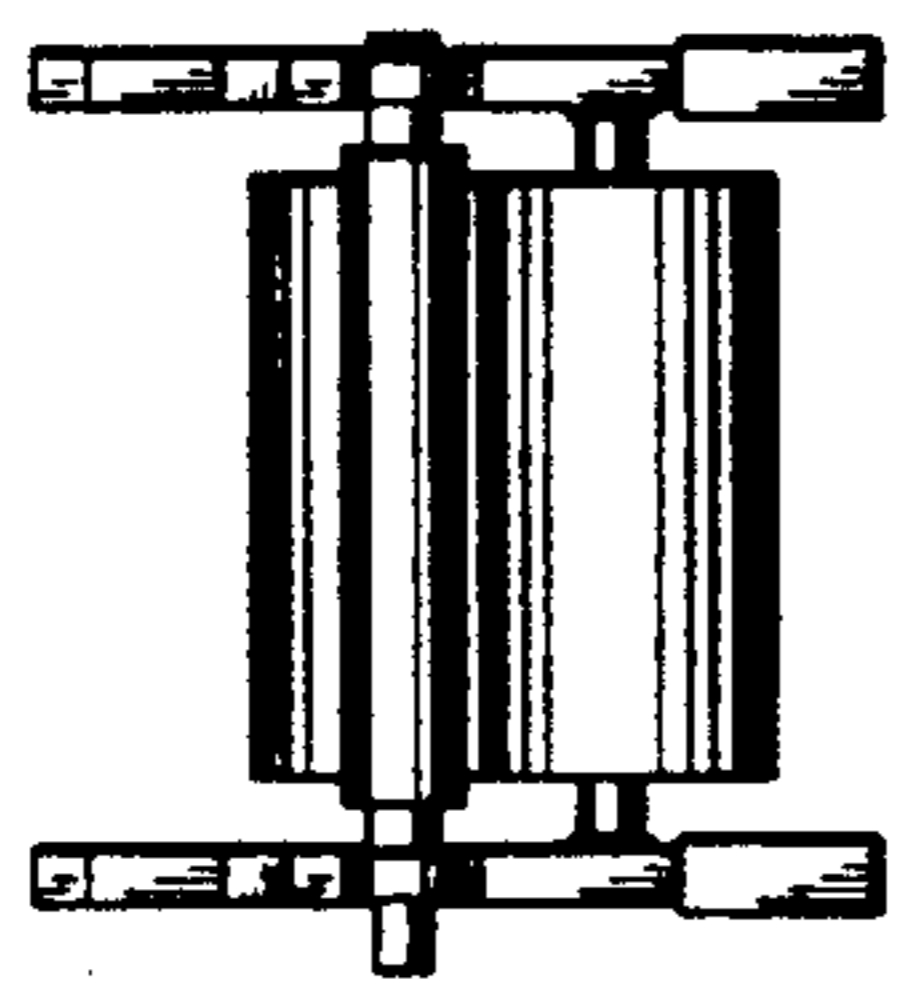

Fig. 11

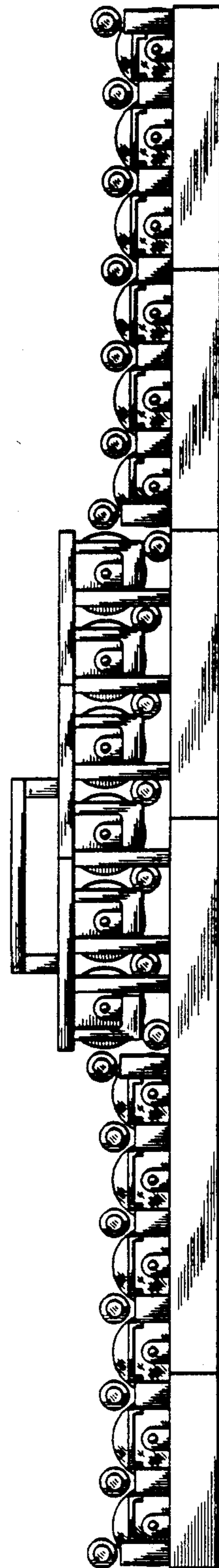

Fig. 13

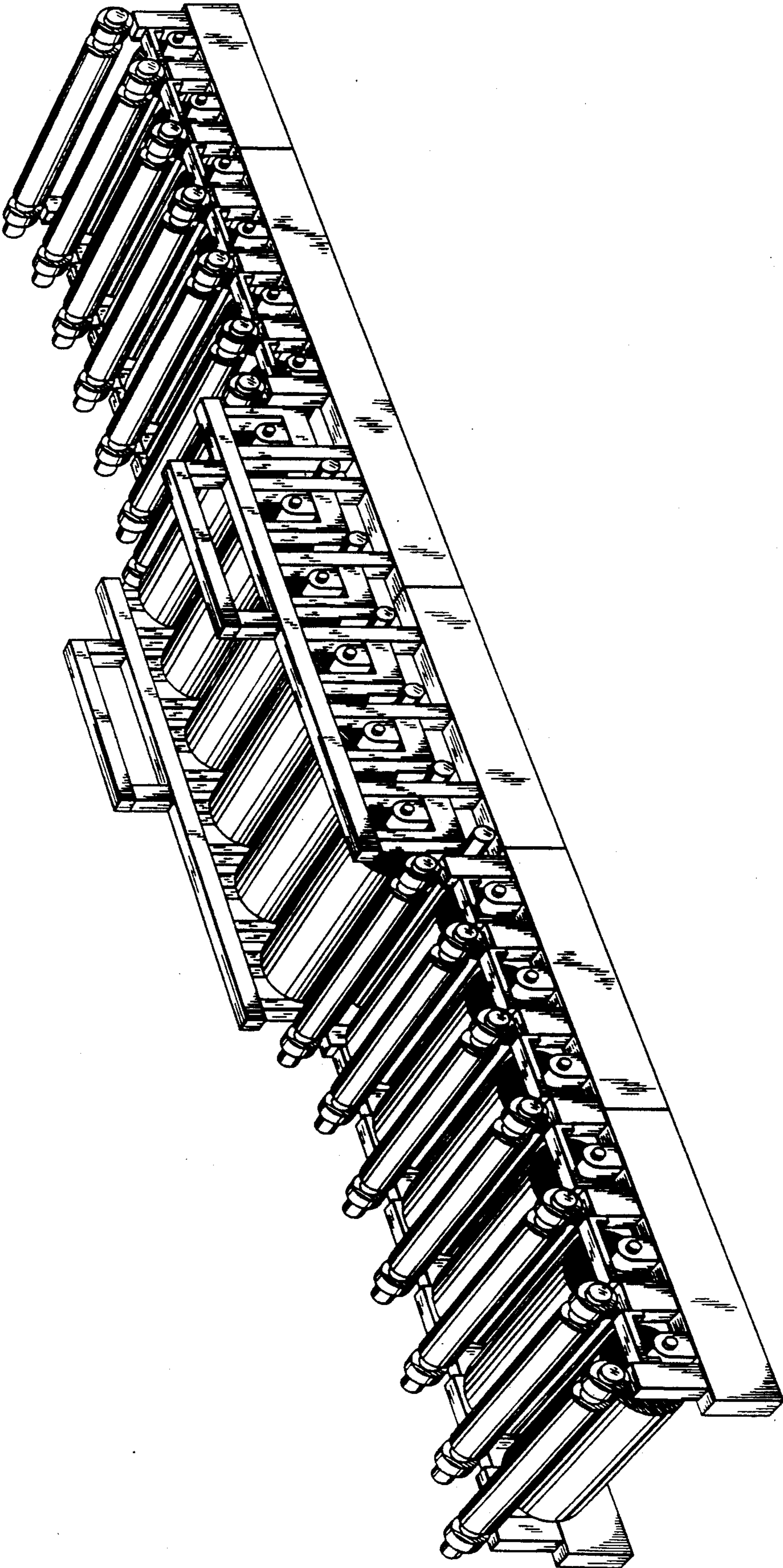

Fig. 14

UNITED STATES PATENT AND TRADEMARK OFFICE
CERTIFICATE OF CORRECTION

PATENT NO. : Des. 320,105
DATED : Sep. 17, 1991
INVENTOR(S) : Borgeir Skaugen, et al.

Page 1 of 3

It is certified that error appears in the above-identified patent and that said Letters Patent is hereby corrected as shown below:

IN THE DRAWINGS

Drawing Sheets, consisting of Figs. 4-6 and 7-9, should be deleted and substitute therefor the attached Drawing Sheets

**Signed and Sealed this
Second Day of February, 1993**

Attest:

Attesting Officer

STEPHEN G. KUNIN

Acting Commissioner of Patents and Trademarks

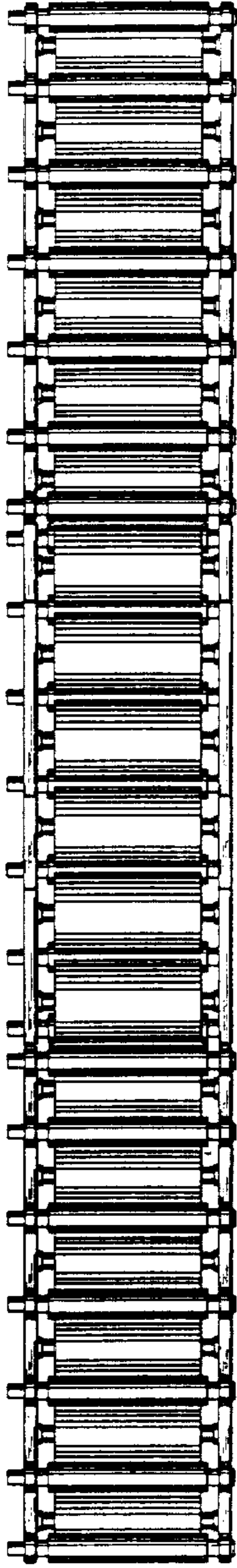

Fig. 5

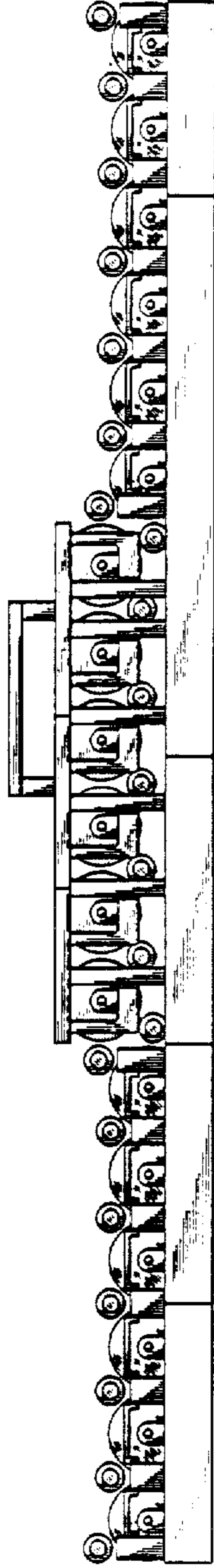

Fig. 4

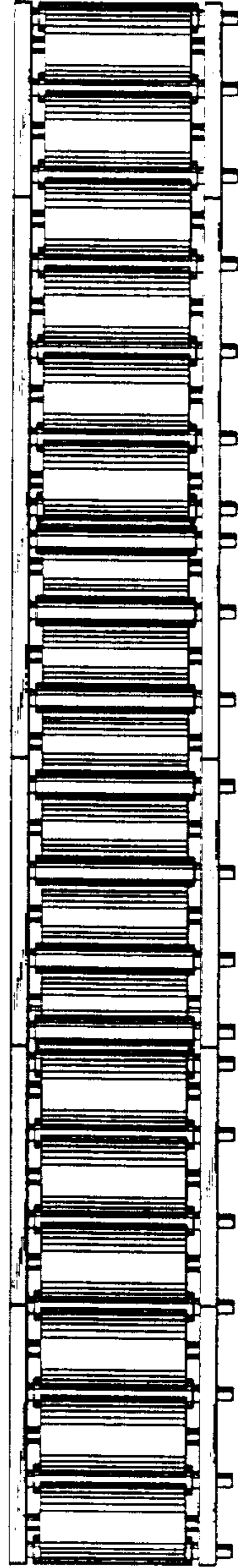

Fig. 6

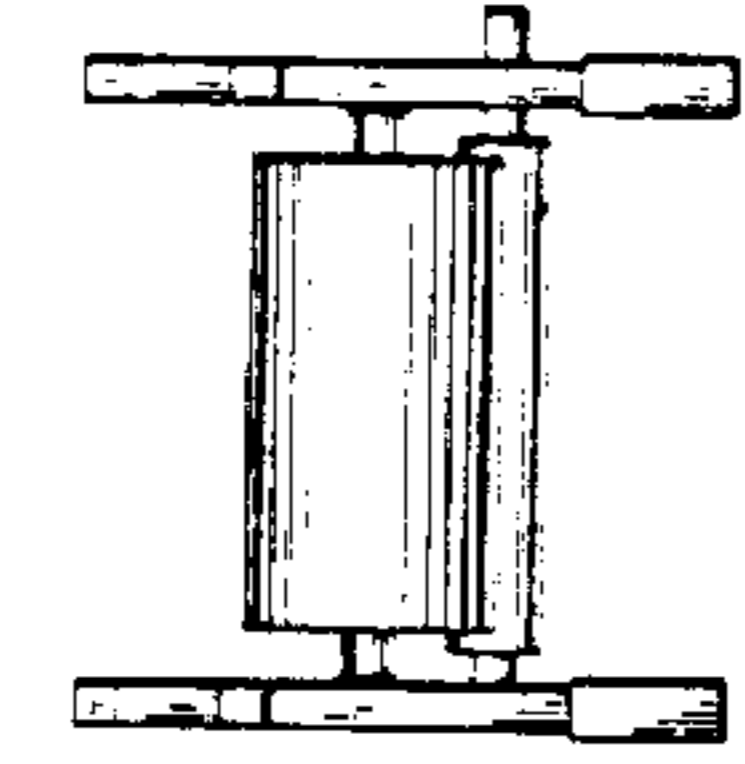

Fig. 7

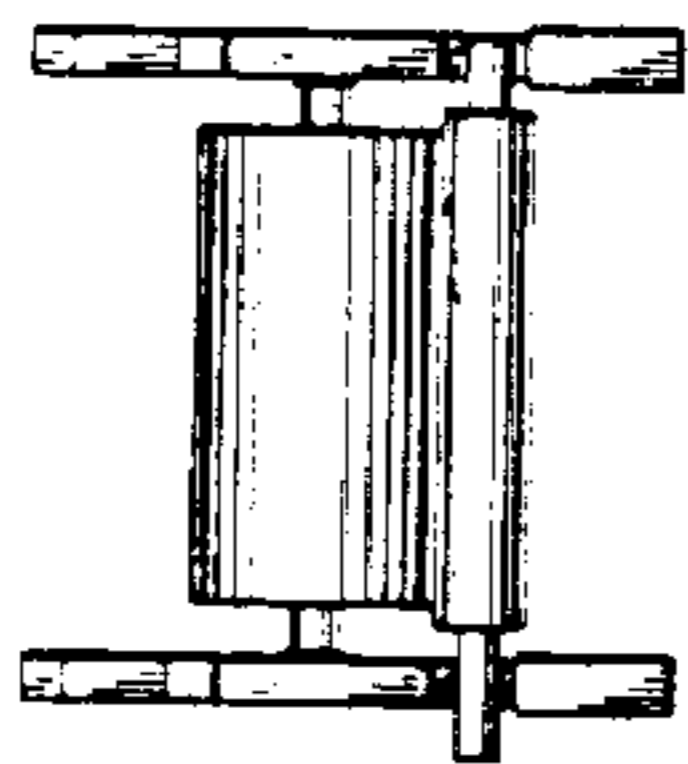

Fig. 8

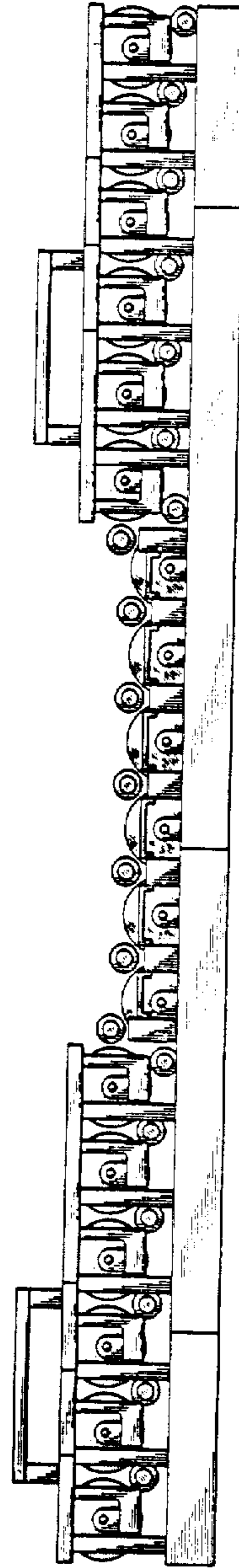

Fig. 9