

[54] LANTERN

[75] Inventor: Kwok Hung Liu, Hong Hong, Hong Kong

[73] Assignees: Transistolite Mfg., Ltd., New Territories; Sol-Lite Mfg. Co., Ltd., Kowloon, both of Hong Kong

[**] Term: 14 Years

[21] Appl. No.: 365,681

[22] Filed: Jun. 13, 1989

[30] Foreign Application Priority Data

Dec. 13, 1988 [GB] United Kingdom 1055661

[52] U.S. Cl. D26/68

[58] Field of Search 362/147, 431, 362, 363, 362/267; D26/67-71

[56] References Cited

U.S. PATENT DOCUMENTS

D. 158,889 6/1950 Morrison D26/68
D. 179,337 12/1956 Brown D26/68

FOREIGN PATENT DOCUMENTS

220896 12/1962 Japan D26/68

OTHER PUBLICATIONS

Progress Lighting Catalog ©, 1980, p. 143, post lantern #P5414.

Thomas Lighting Catalog, © 1980, p. 133, post lantern #M-5615-47.

Primary Examiner—Susan J. Lucas

Attorney, Agent, or Firm—Fleit, Jacobson, Cohn, Price, Holman & Stern

[57] CLAIM

The ornamental design for a lantern, as shown and described.

DESCRIPTION

FIG. 1 is a perspective view from above of a lantern showing my new design;

FIG. 2 is a perspective view from below thereof;

FIG. 3 is a front elevational view thereof;

FIG. 4 is a side elevational view thereof, the opposite side being identical except for elements on the front of the post;

FIG. 5 is a rear elevational view thereof.

FIG. 6 is a top plan view thereof; and

FIG. 7 is a bottom plan view thereof.

The post is broken away to indicate indeterminate length.

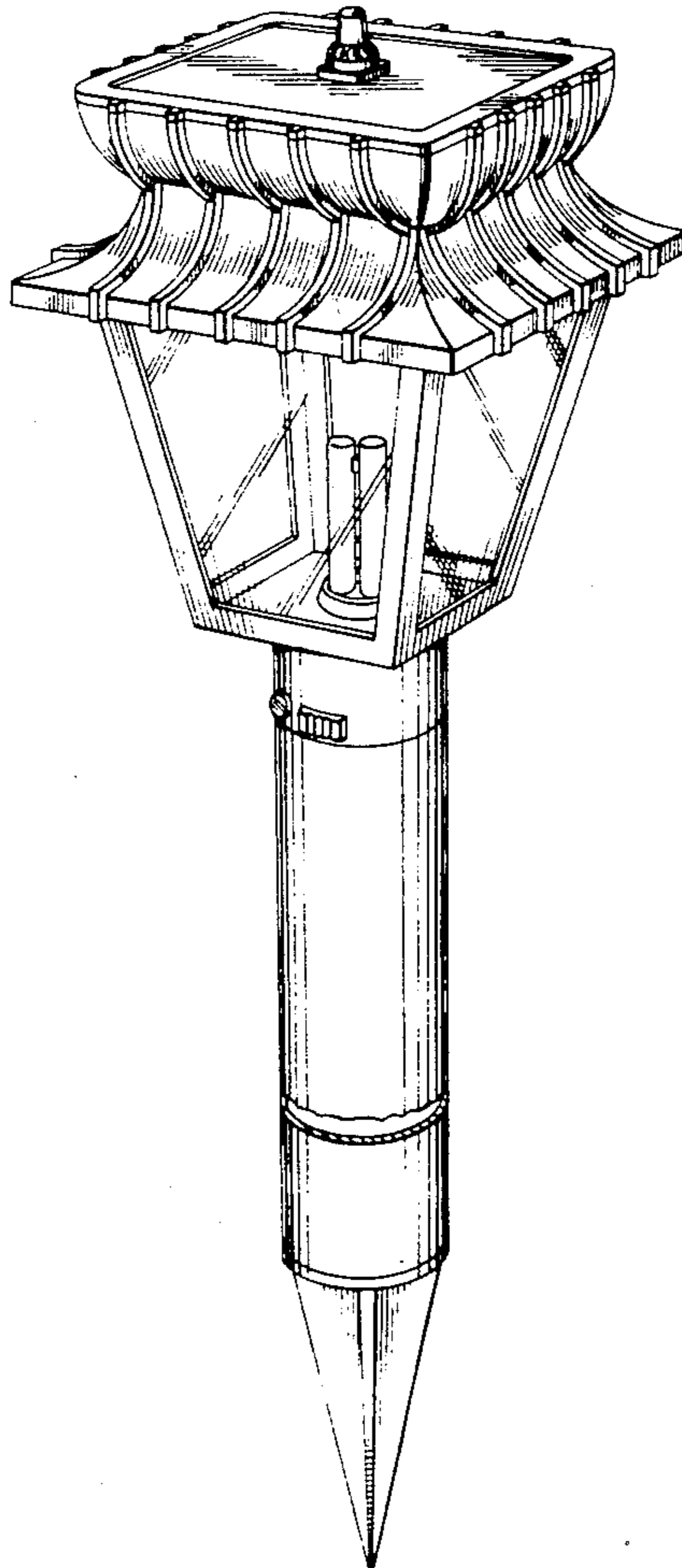

FIG. 1

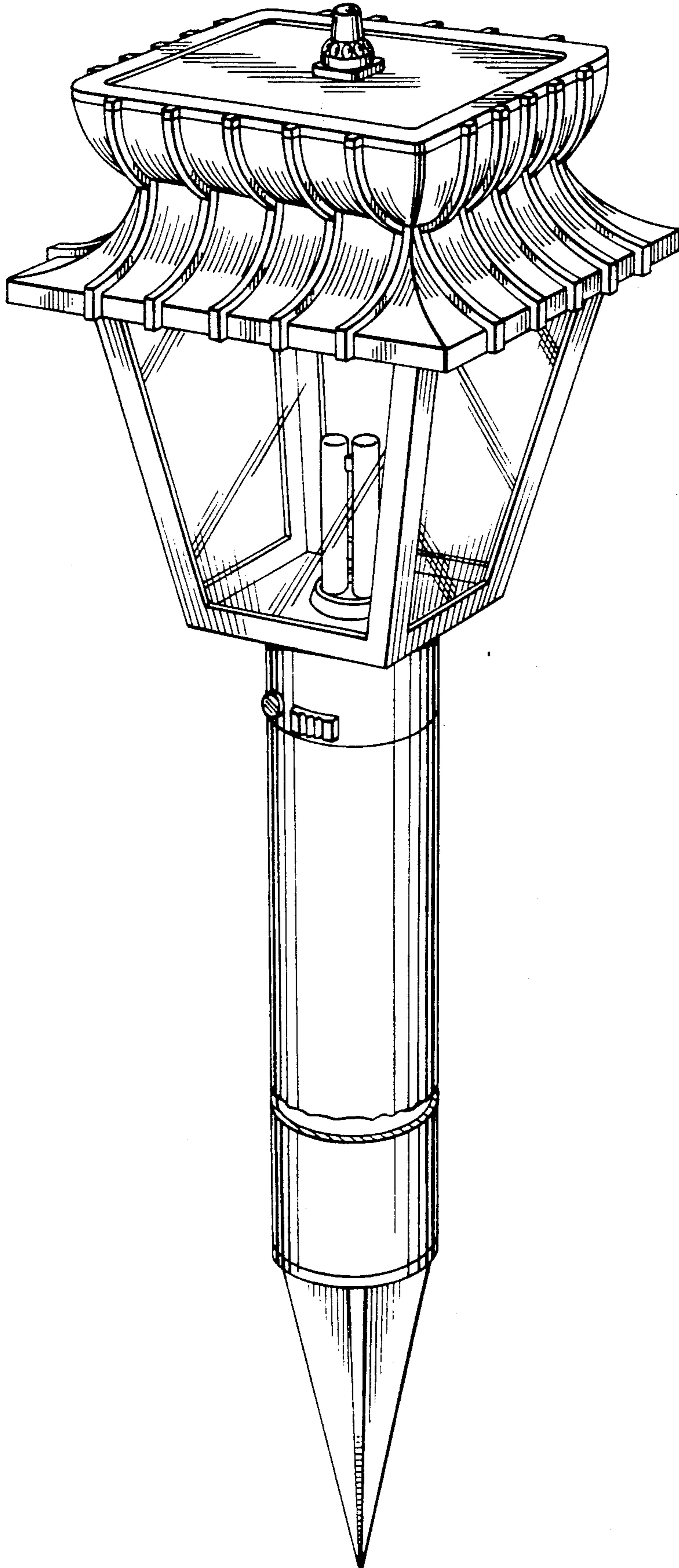

FIG. 2

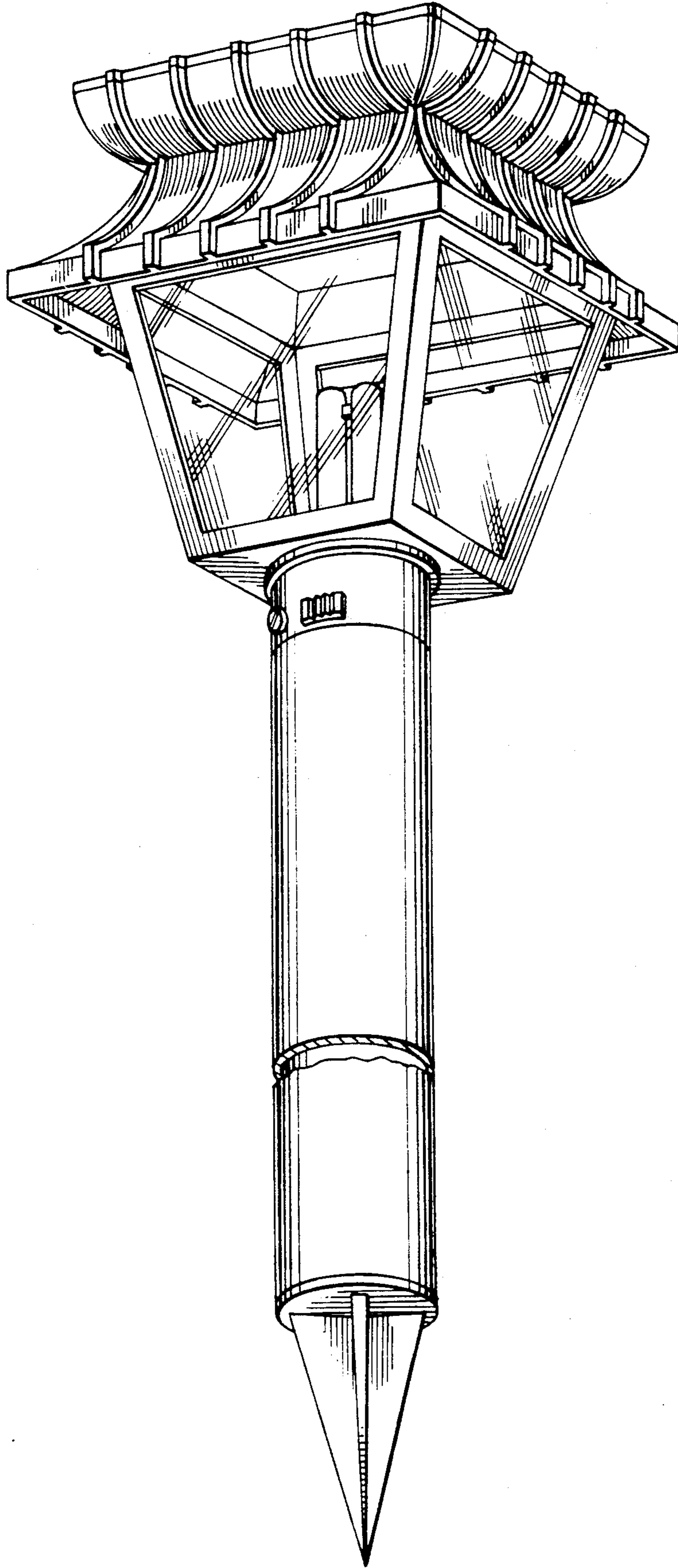

FIG. 3

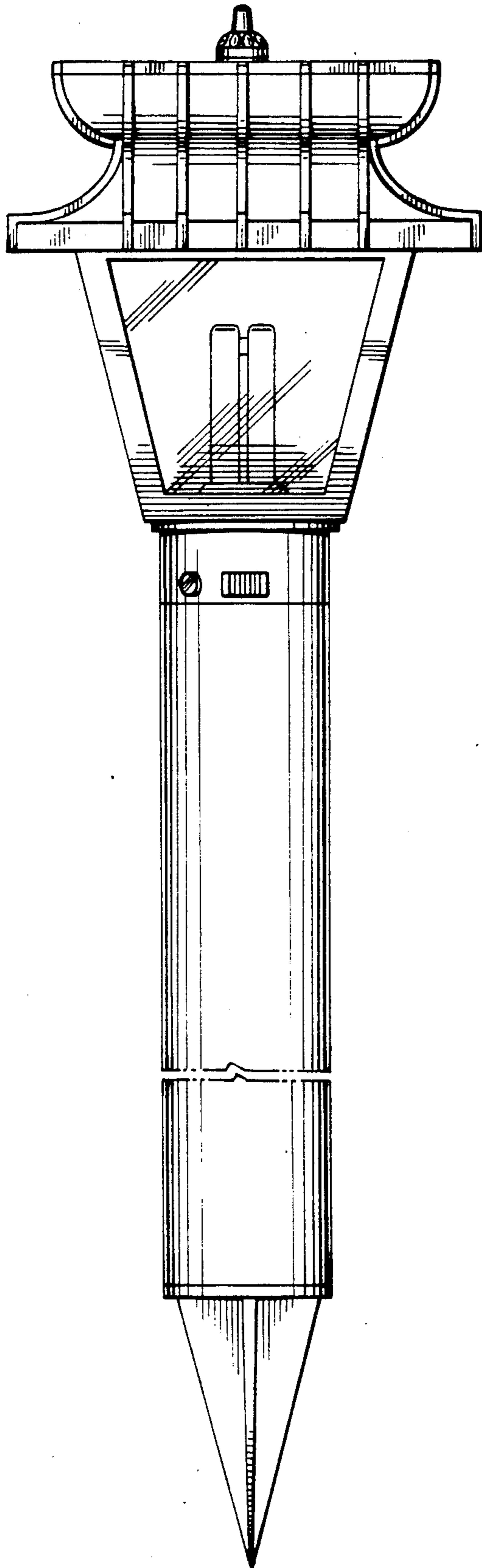

FIG. 4

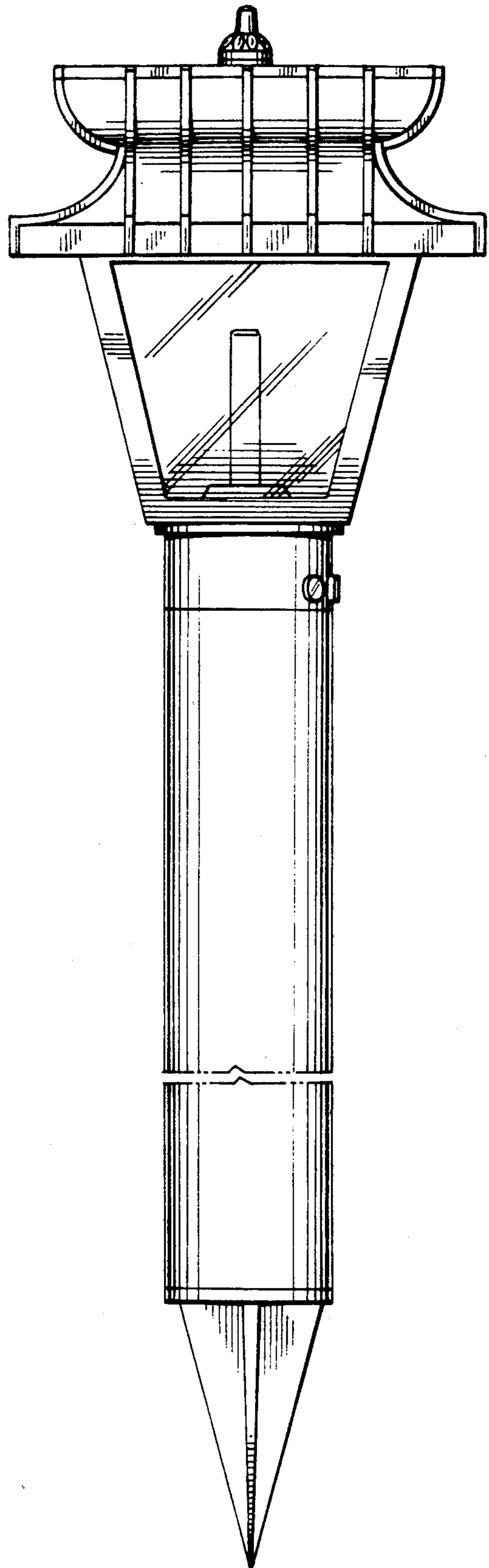

FIG. 5

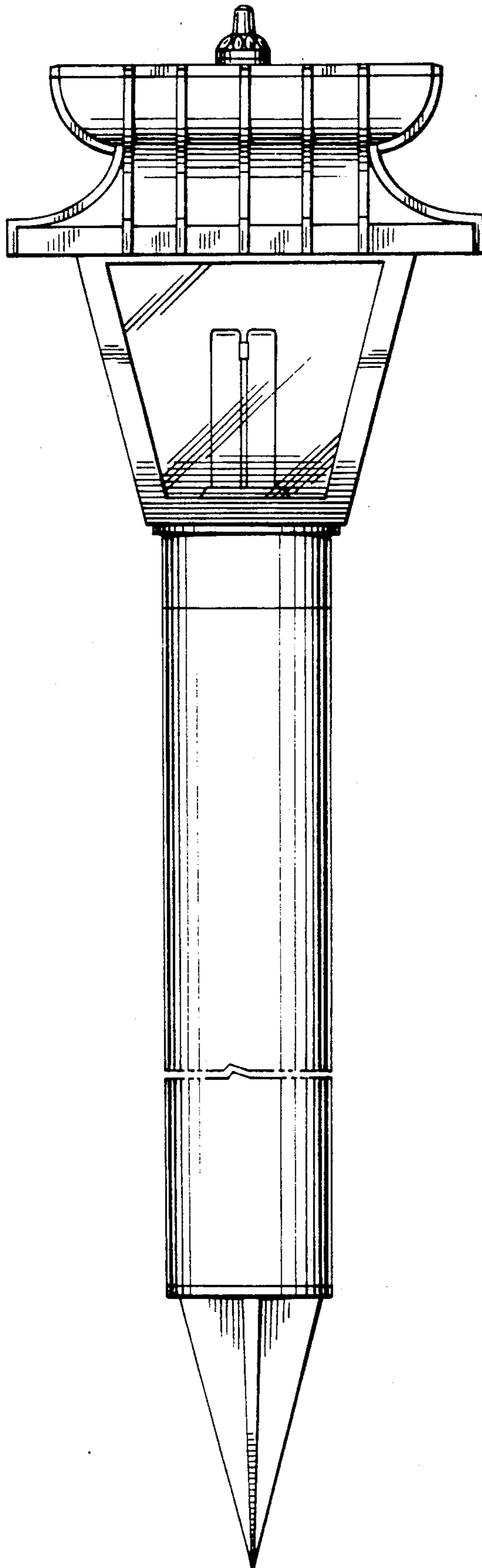

FIG. 6

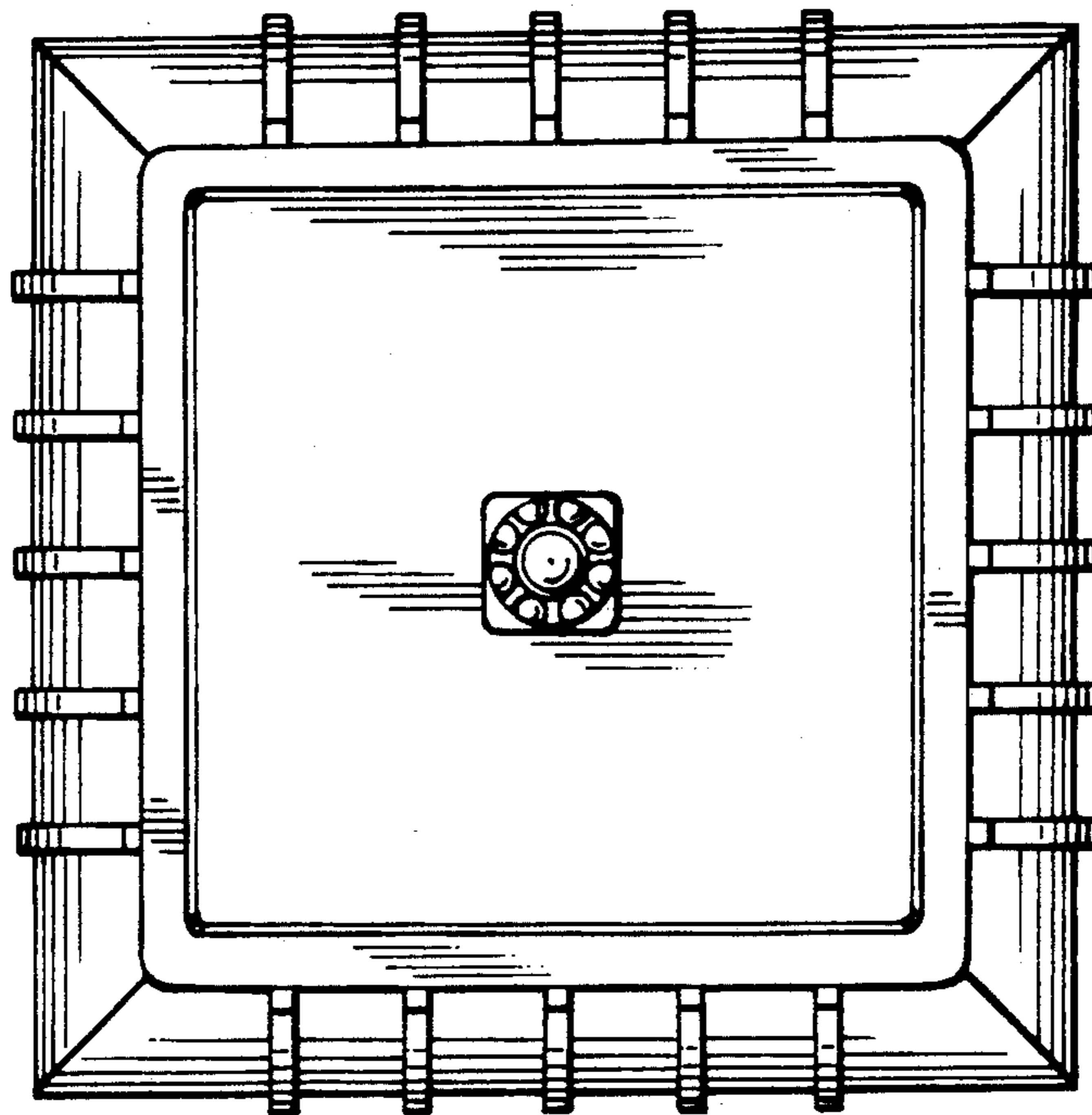

FIG. 7

