

[54] CAP FOR TIMING CHAIN COVER

[75] Inventor: William J. Segal, Torrance, Calif.

[73] Assignee: Mr. Gasket Company, Cleveland, Ohio

[**] Term: 14 Years

[21] Appl. No.: 278,165

[22] Filed: Nov. 30, 1988

[52] U.S. Cl. D15/5

[58] Field of Search D15/5, 1; 74/609

[56] References Cited

U.S. PATENT DOCUMENTS

D. 43,826	4/1913	Peters	D15/5
D. 217,314	4/1970	Smith	D15/5
1,105,219	7/1914	Stull	74/609
1,174,072	3/1916	Hurteau	74/609
3,667,318	6/1972	Look	74/609

OTHER PUBLICATIONS

J. C. Whitney & Co., Catalog, p. 18—upper left corner.

Primary Examiner—Louis S. Zarfes

Assistant Examiner—R. T. Seifert

Attorney, Agent, or Firm—Body, Vickers & Daniels

[57] CLAIM

The ornamental design for a cap for timing chain cover, as shown and described.

DESCRIPTION

FIG. 1 is a perspective view of a cap for timing chain cover showing my new design;

FIG. 2 is a front elevational view;

FIG. 3 is a rear elevational view;

FIG. 4 is a side elevational view;

FIG. 5 is a top plan view;

FIG. 6 is a bottom plan view;

FIG. 7 is a perspective view indicating the position of placement when in use.

The broken line showing of an engine is for illustrative purposes only and forms no part of the claimed design.

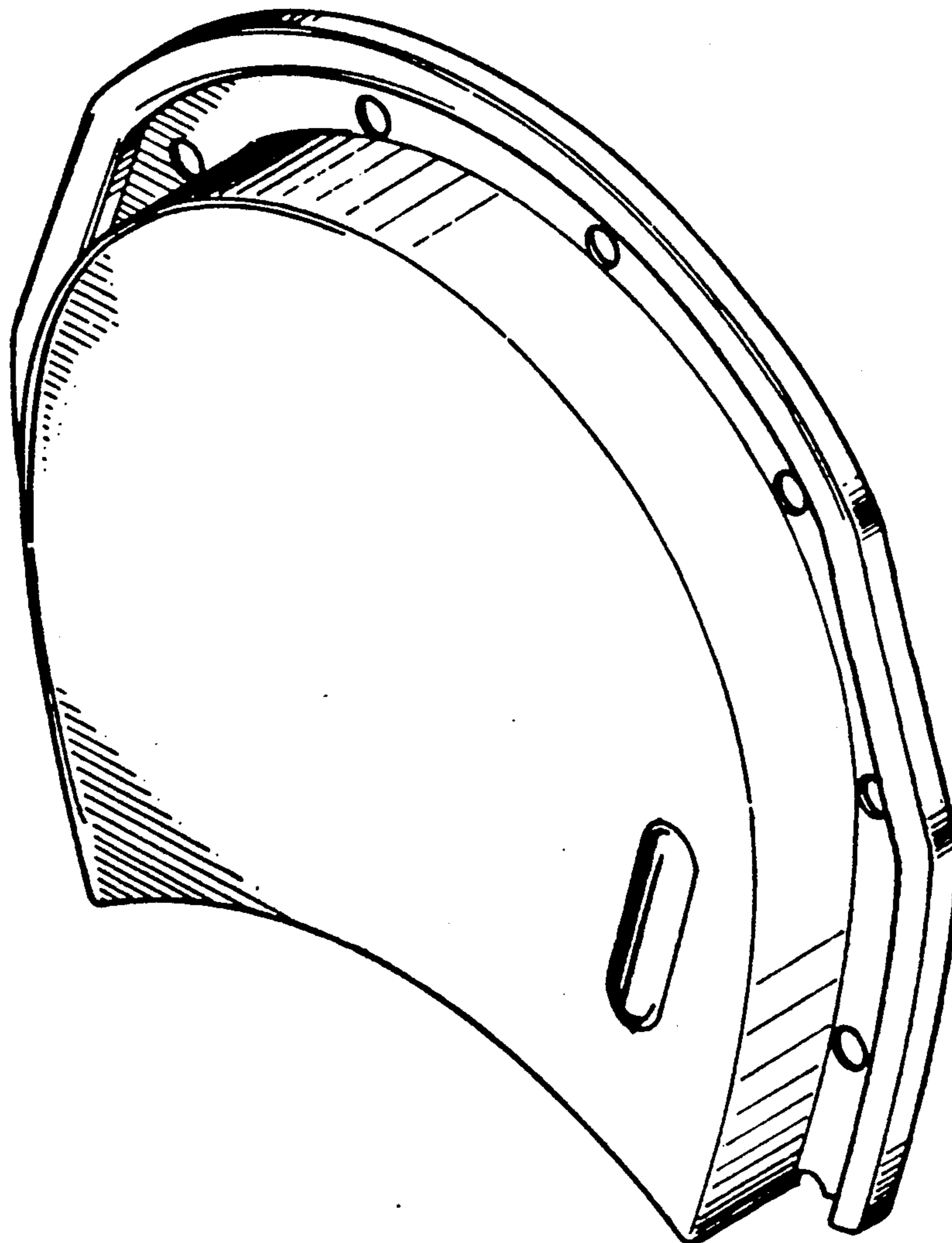

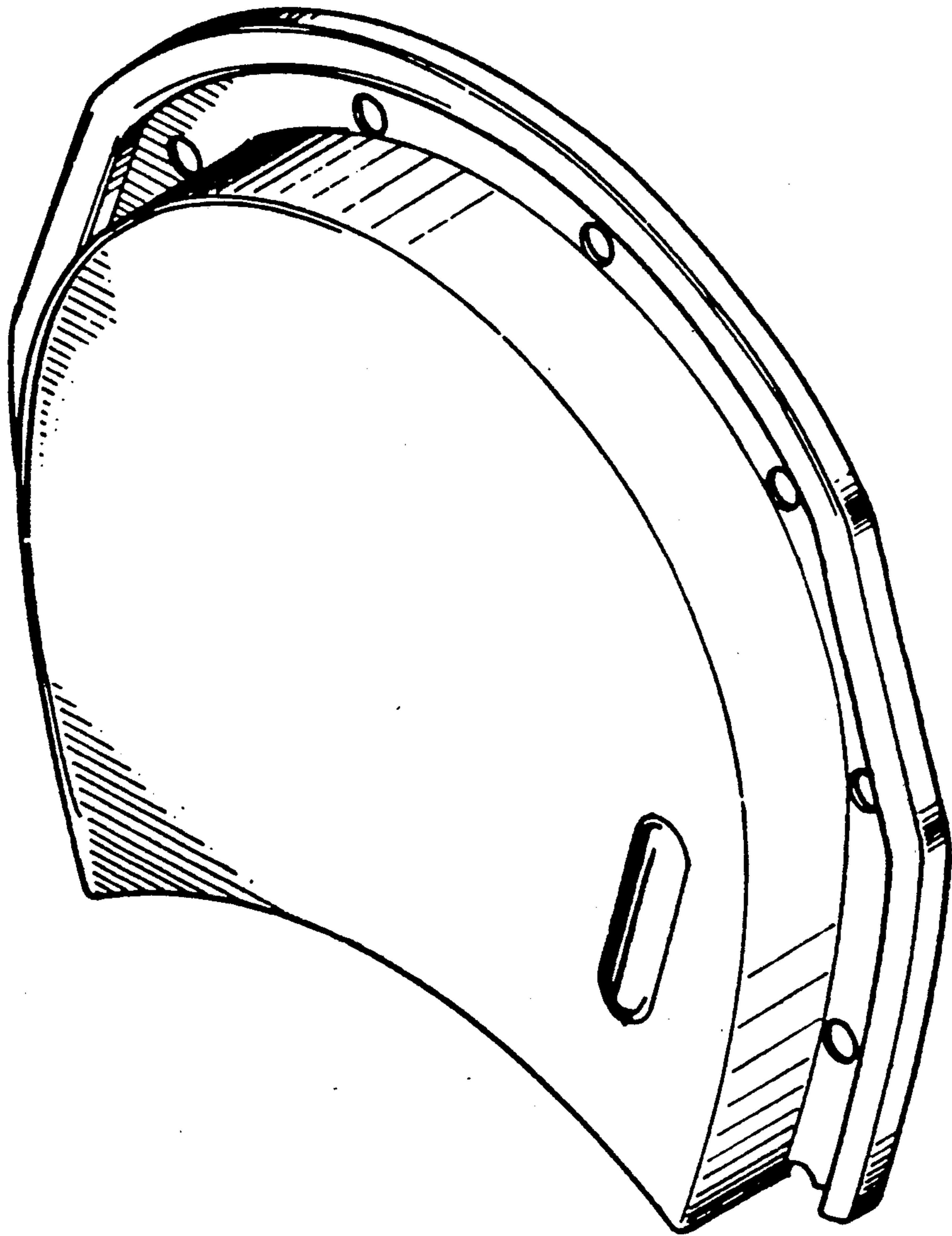

FIG. 1

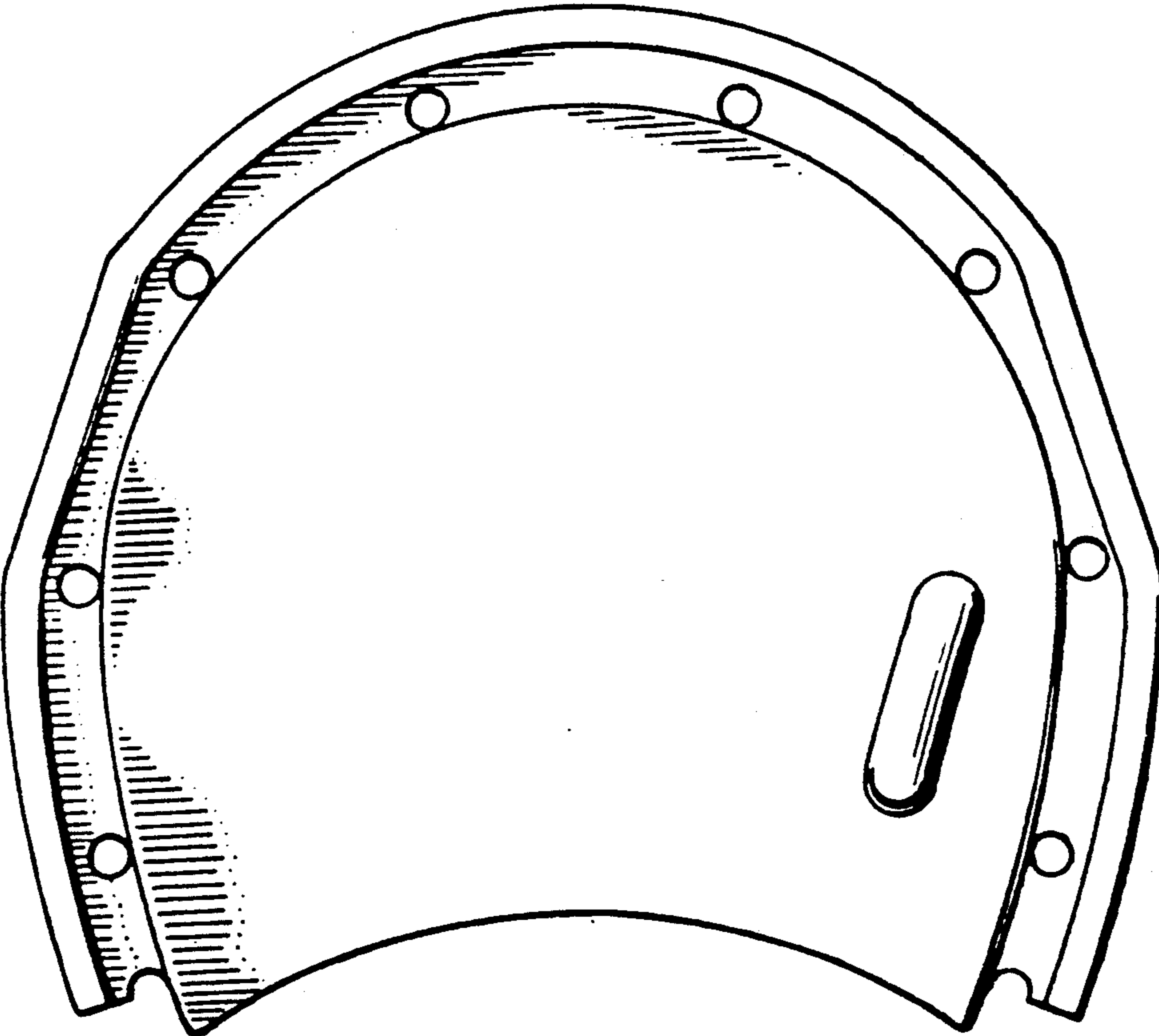

FIG. 2

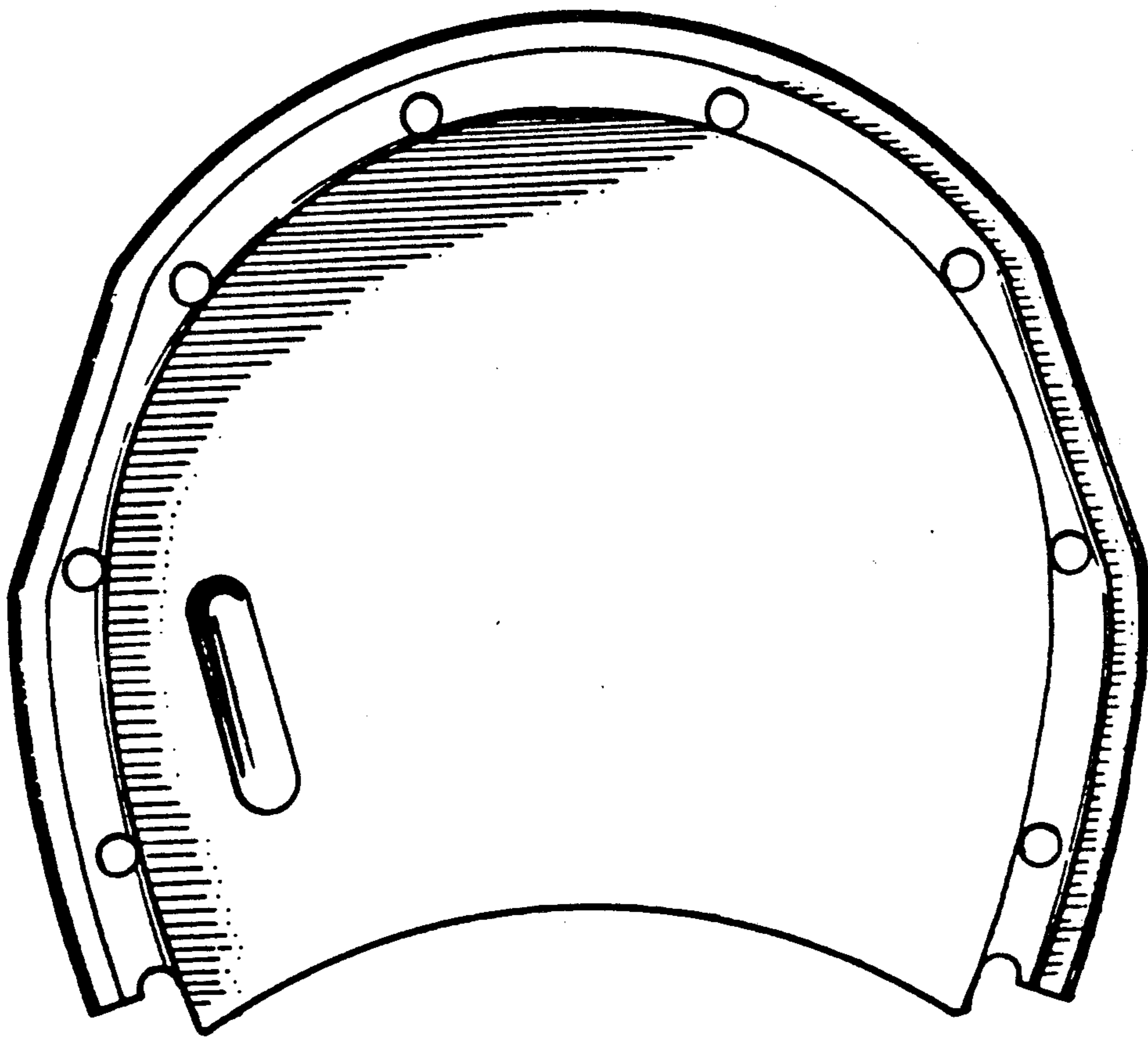

FIG. 3

FIG. 4

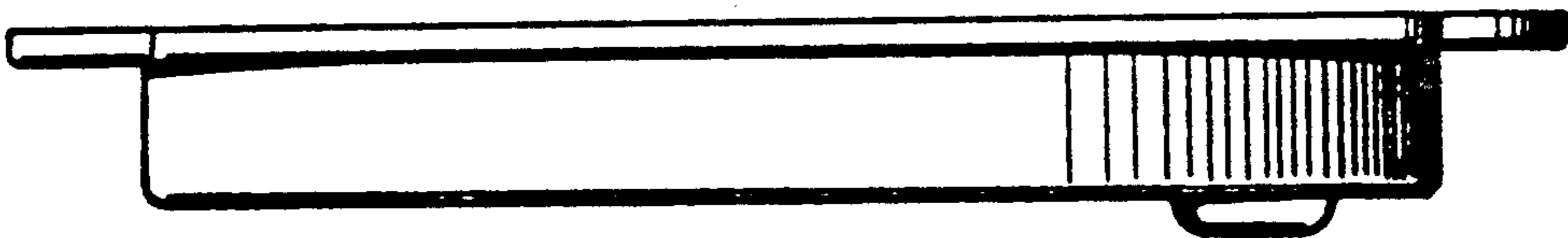

FIG. 5

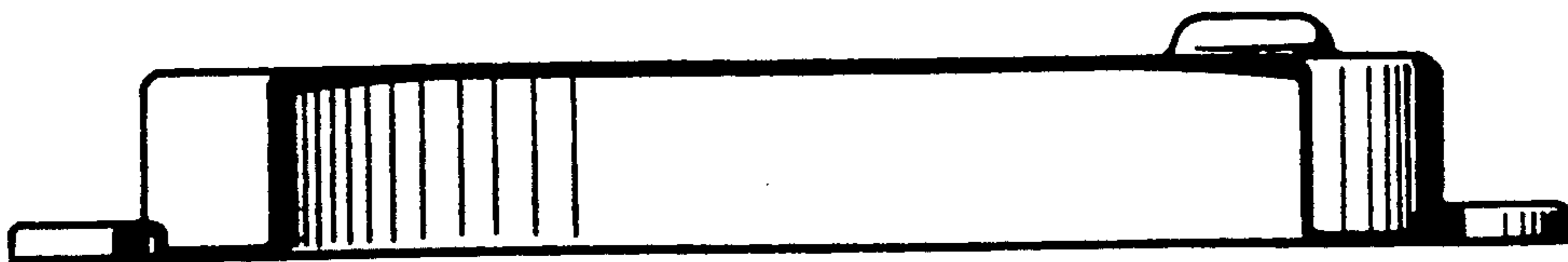

FIG. 6

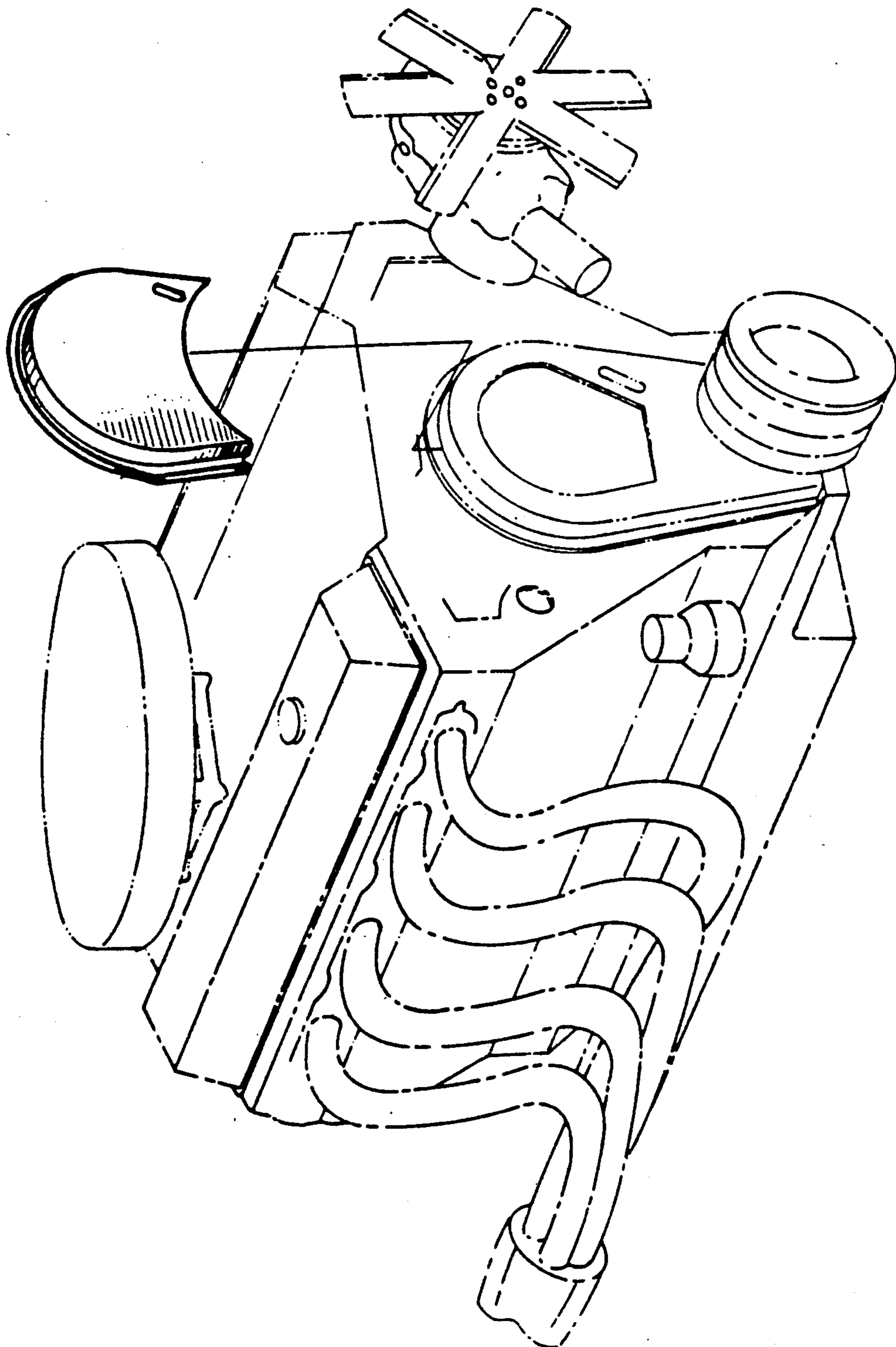

FIG. 7