

[54] FOLDABLE TRAY UNIT FOR A PRODUCT MERCHANDISING DISPLAY STAND

2,896,788 7/1959 Hoffberger ..... D24/29 X  
4,124,159 11/1978 Schwarzkopf ..... D9/432 X

[75] Inventor: William G. Ehlebracht, West Des Moines, Iowa

Primary Examiner—Bruce W. Dunkins  
Assistant Examiner—Jeffrey Asch  
Attorney, Agent, or Firm—Rudolph L. Lowell

[73] Assignee: Chesapeake Display and Packaging Company, West Des Moines, Iowa

[57] CLAIM

[\*\*] Term: 14 Years

The ornamental design for a foldable tray unit for a product merchandising display stand, as shown and described.

[21] Appl. No.: 168,753

[22] Filed: Mar. 16, 1988

DESCRIPTION

[52] U.S. Cl. .... D6/510; D6/475; D9/414; D9/430

[58] Field of Search ..... D6/429, 430, 431, 449, D6/490, 492, 491, 466, 475, 476, 510; D9/432, 433, 443, 431, 414, 430; D7/550; D24/29

FIG. 1 is a perspective view of a foldable tray unit for a product merchandising display stand showing my new design in its folded position for use;

FIG. 2 is a side elevational view thereof, the sides not shown being identical in appearance thereto;

FIG. 3 is a top plan view thereof;

FIG. 4 is a bottom plan view thereof;

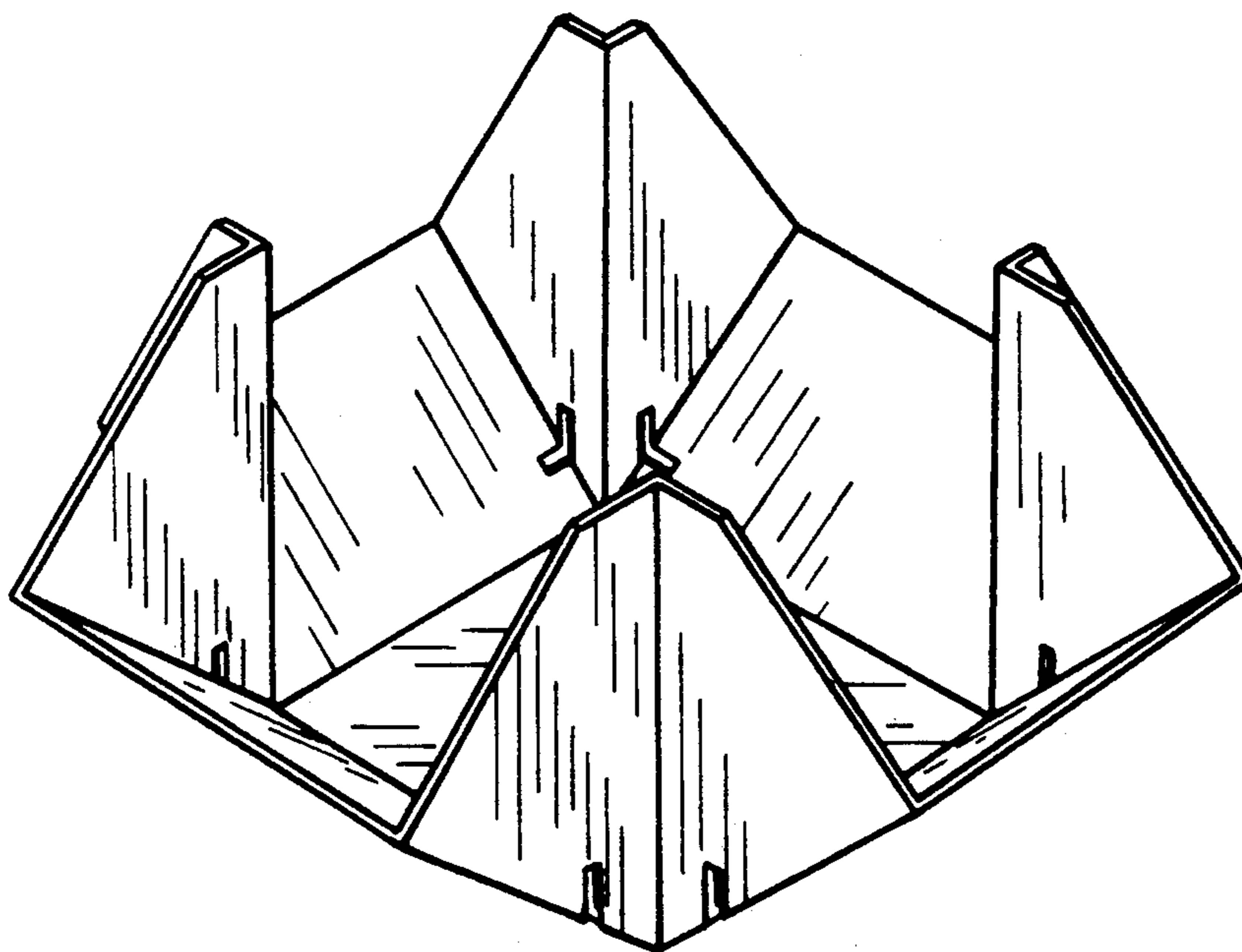
FIG. 5 is a top plan view thereof in an unfolded condition; and

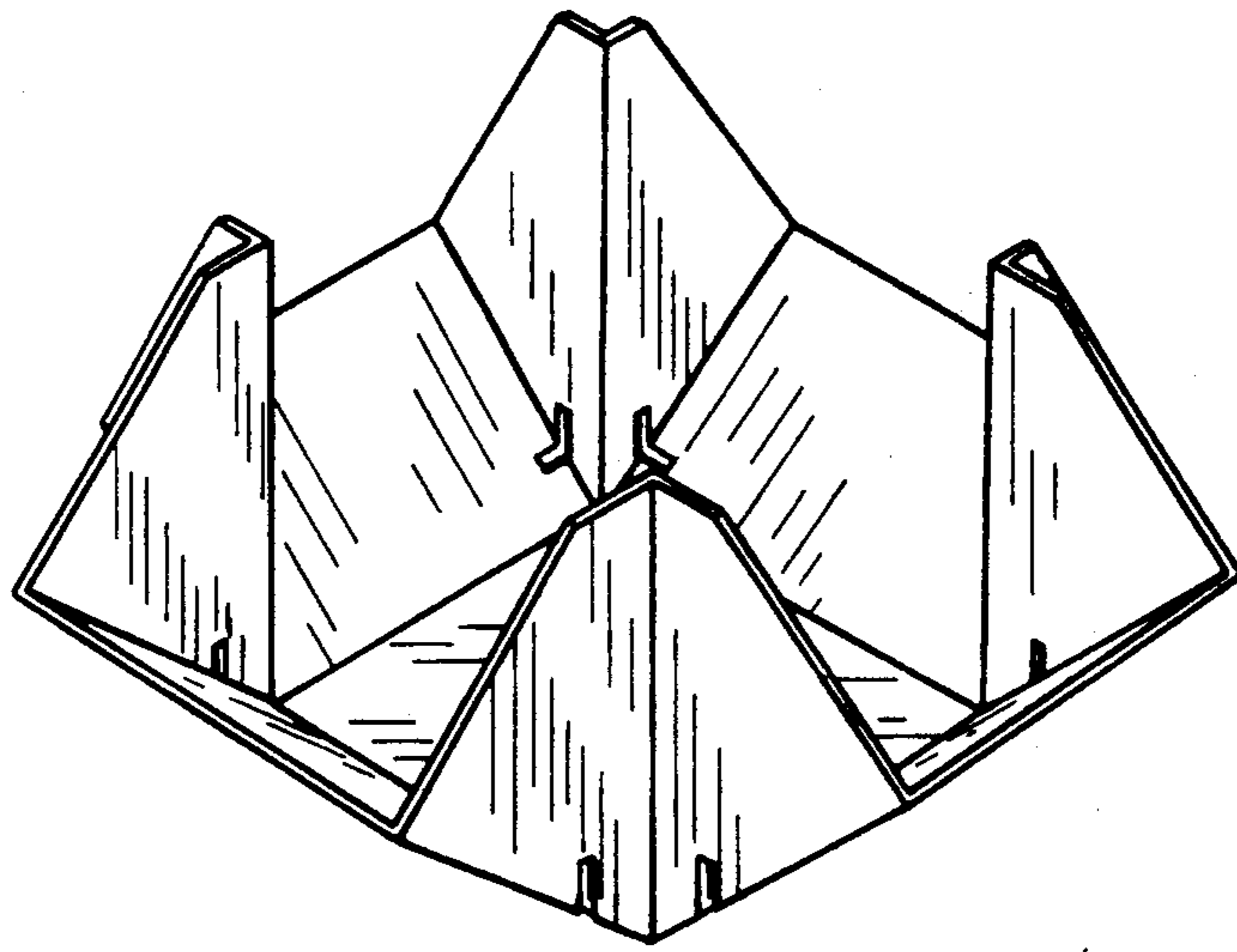
FIG. 6 is a perspective view thereof in its folded position for use wherein a display stand has been shown in broken lines for illustrative purposes only.

[56] References Cited

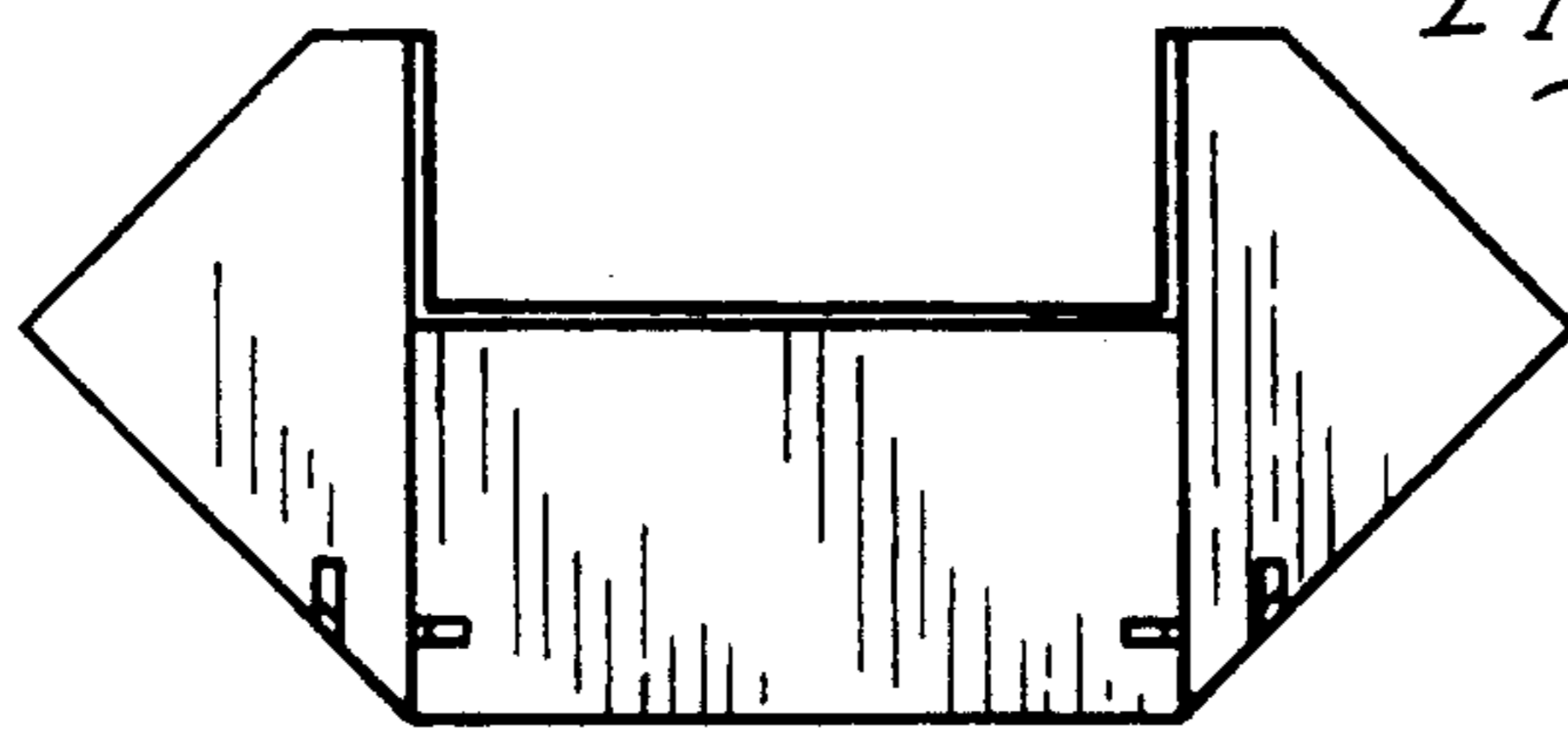
U.S. PATENT DOCUMENTS

- D. 50,543 3/1917 Wheelock ..... D7/550
- D. 168,472 12/1952 Parker ..... D9/443
- D. 236,538 8/1975 Adams ..... D6/490 X
- D. 287,466 12/1986 Gardner ..... D9/431 X



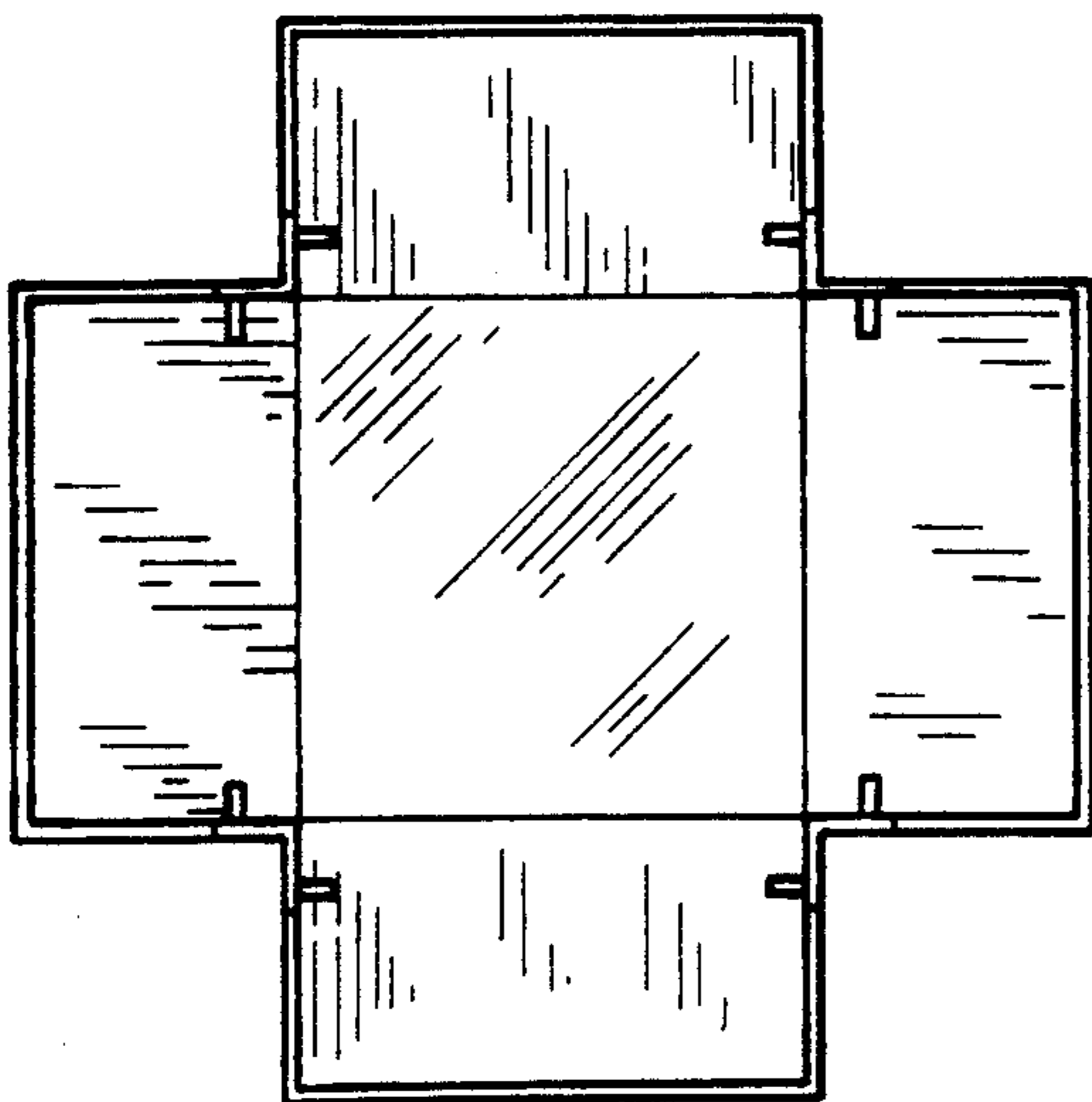


*Fig. 1*

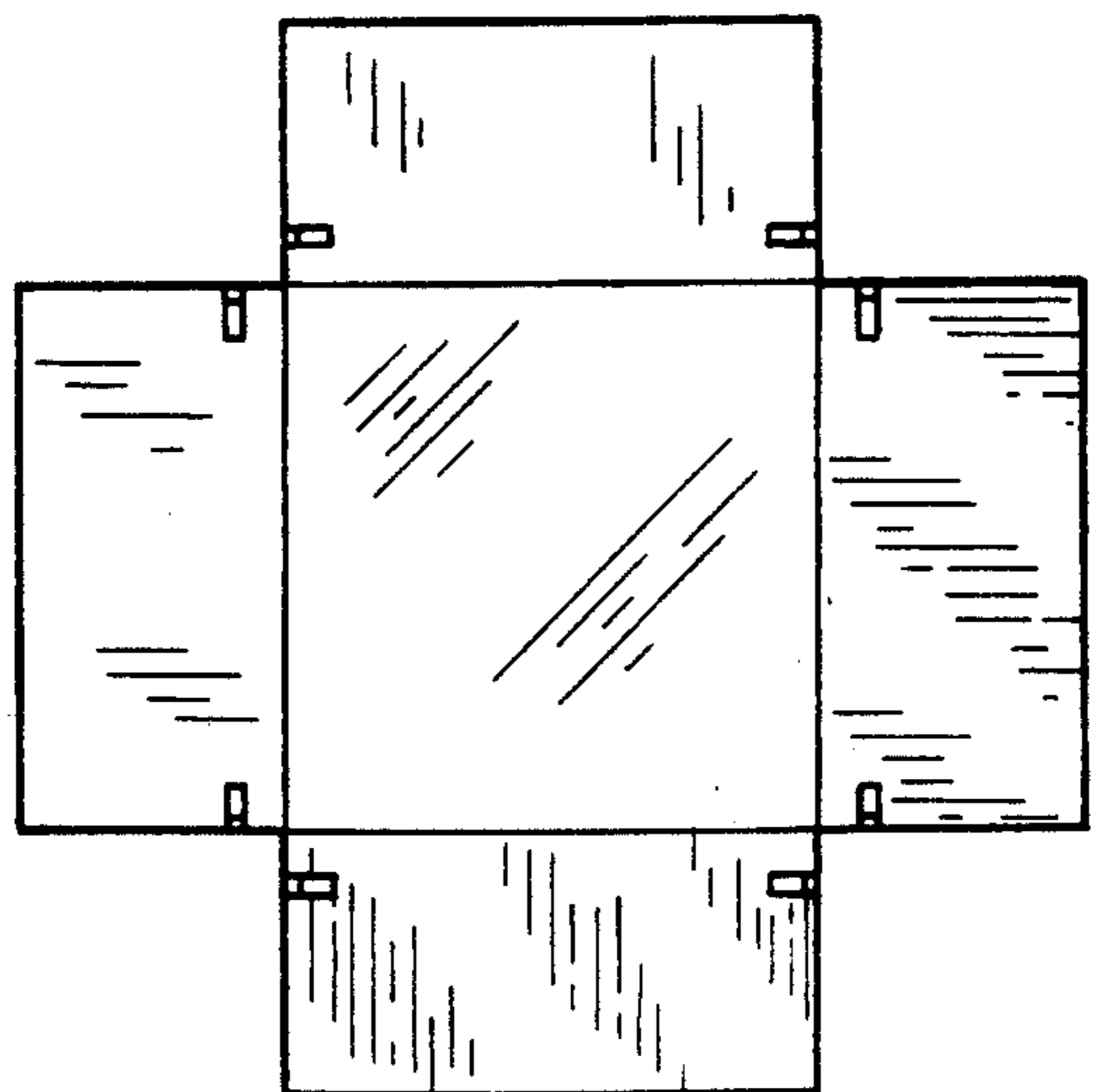


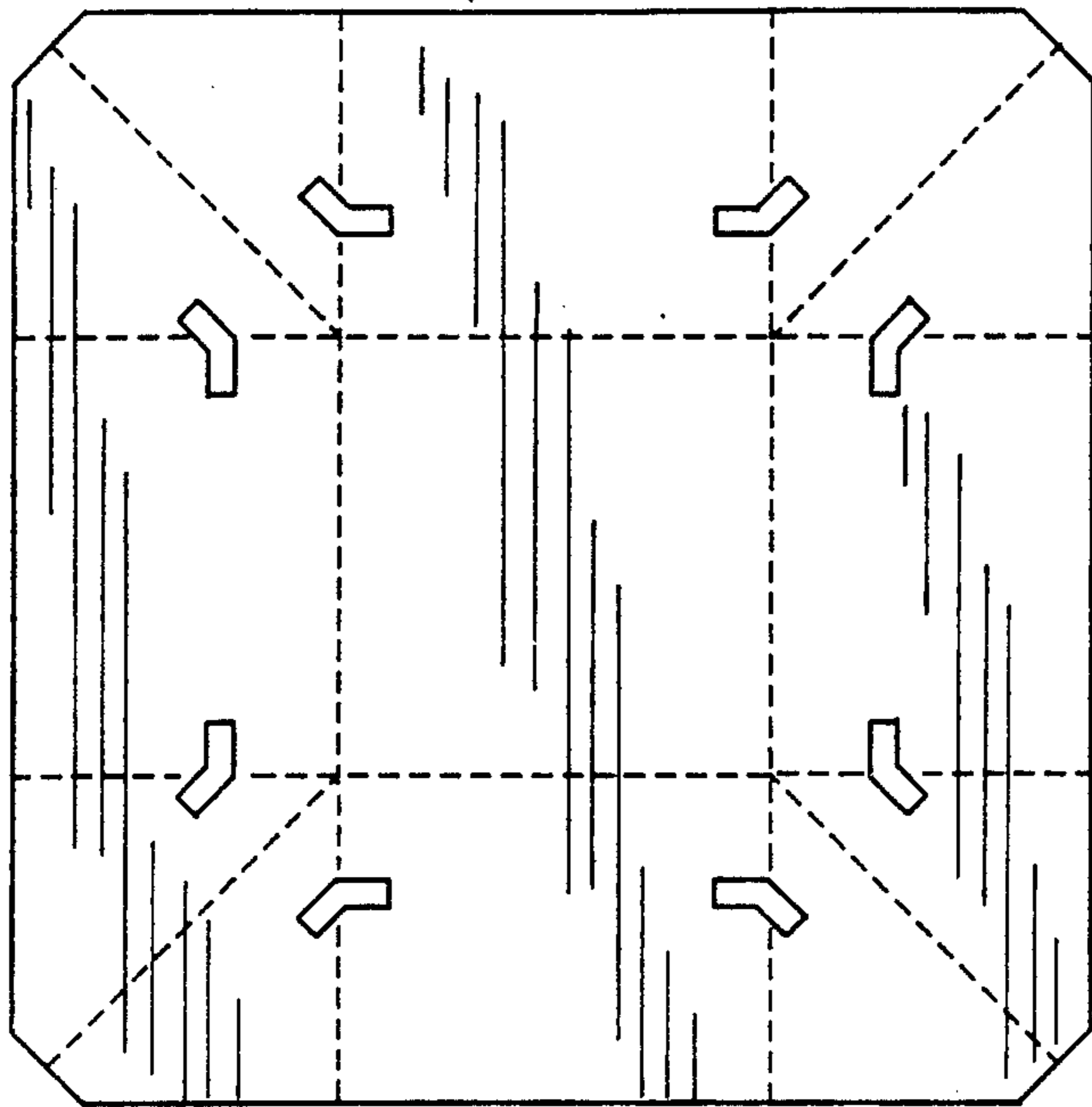
*Fig. 2*

*Fig. 3*

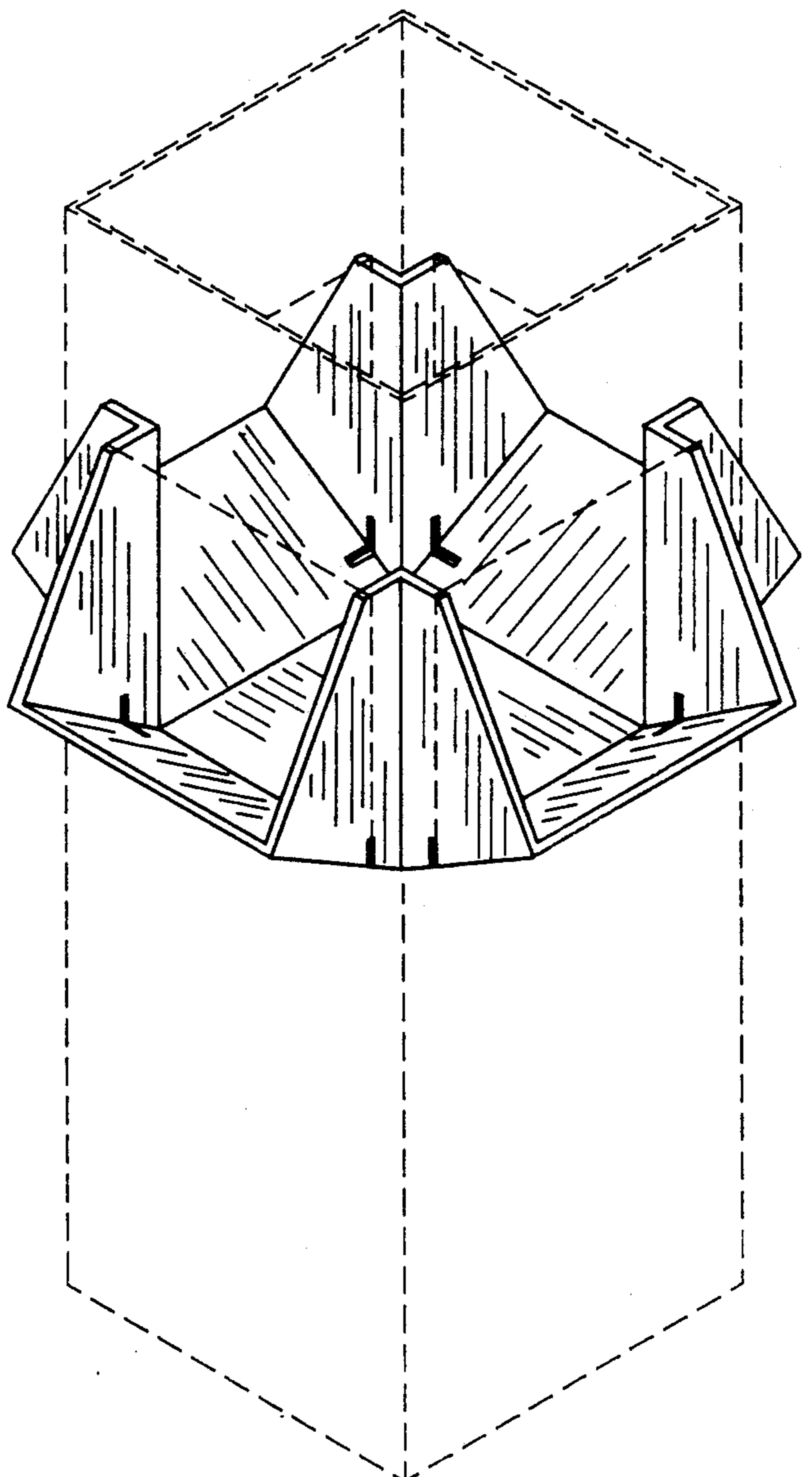


*Fig. 4*





*Fig 5*



*Fig 6*