

[54] COIN CASE

3,982,628 9/1976 Rodenas 206/566 X

[75] Inventor: Shintaro Tsuji, Tokyo, Japan

OTHER PUBLICATIONS

[73] Assignee: Sanrio Company Ltd., Tokyo, Japan

Cycle World, Sep. 1982, p. 75, Motorcycle Helmets.

[**] Term: 14 Years

Primary Examiner—Louis S. Zarfes

[21] Appl. No.: 229,541

Assistant Examiner—M. N. Pandozzi

[22] Filed: Aug. 5, 1988

Attorney, Agent, or Firm—Owen, Wickersham & Erickson

[52] U.S. Cl. D99/37; D3/44; D3/66

[57] CLAIM

The ornamental design for a coin case, as shown.

[58] Field of Search D3/65, 99, 44, 42, 46, D3/30.1, 66; D99/34, 37; D29/12, 14, 15; 206/0.84, 0.82, 566, 0.8, 0.81; 150/150

DESCRIPTION

[56] References Cited

U.S. PATENT DOCUMENTS

- D. 39,617 10/1908 Wilkins D3/44
- D. 196,659 10/1963 Hartley D99/37
- D. 209,219 11/1967 Goldstein D99/37
- 191,336 5/1877 Guild D99/34 X

FIG. 1 is a perspective view of a coin case showing my new design;

FIG. 2 is a right side elevational view thereof;

FIG. 3 is a front elevational view thereof;

FIG. 4 is a rear elevational view thereof;

FIG. 5 is a top plan view thereof;

FIG. 6 is a bottom plan view thereof;

FIG. 7 is a sectional view thereof.

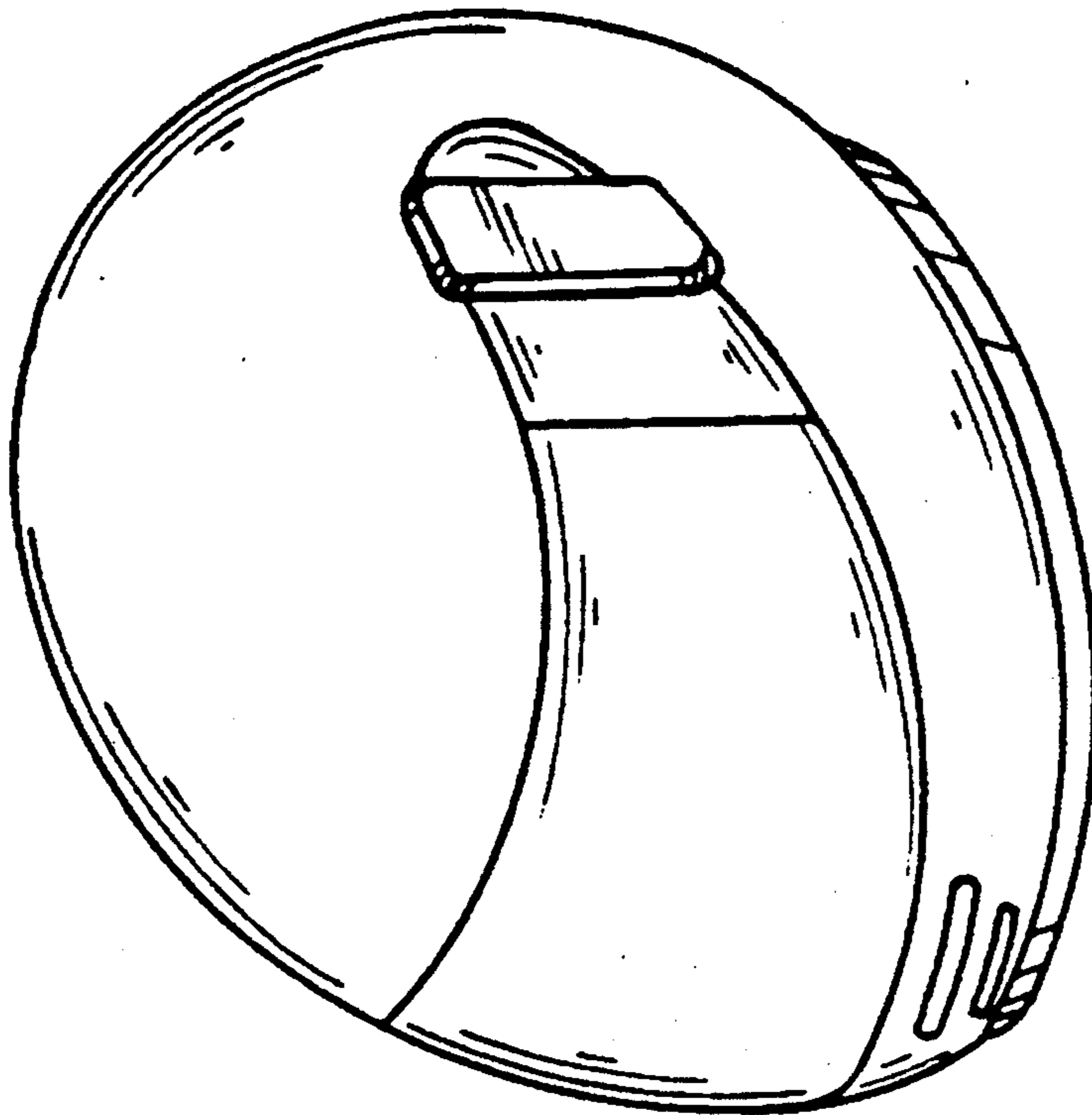

FIG. 1

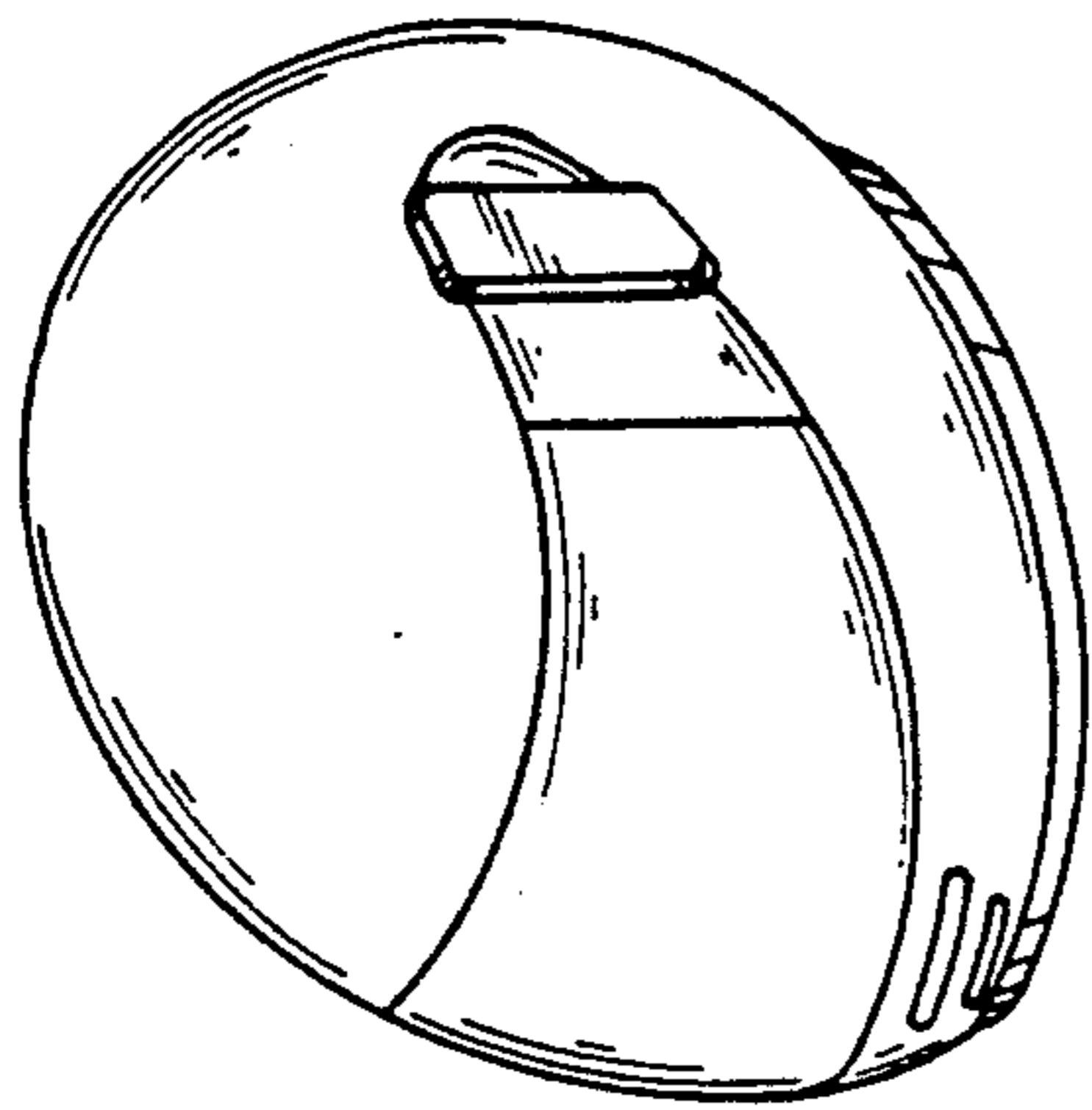

FIG. 5

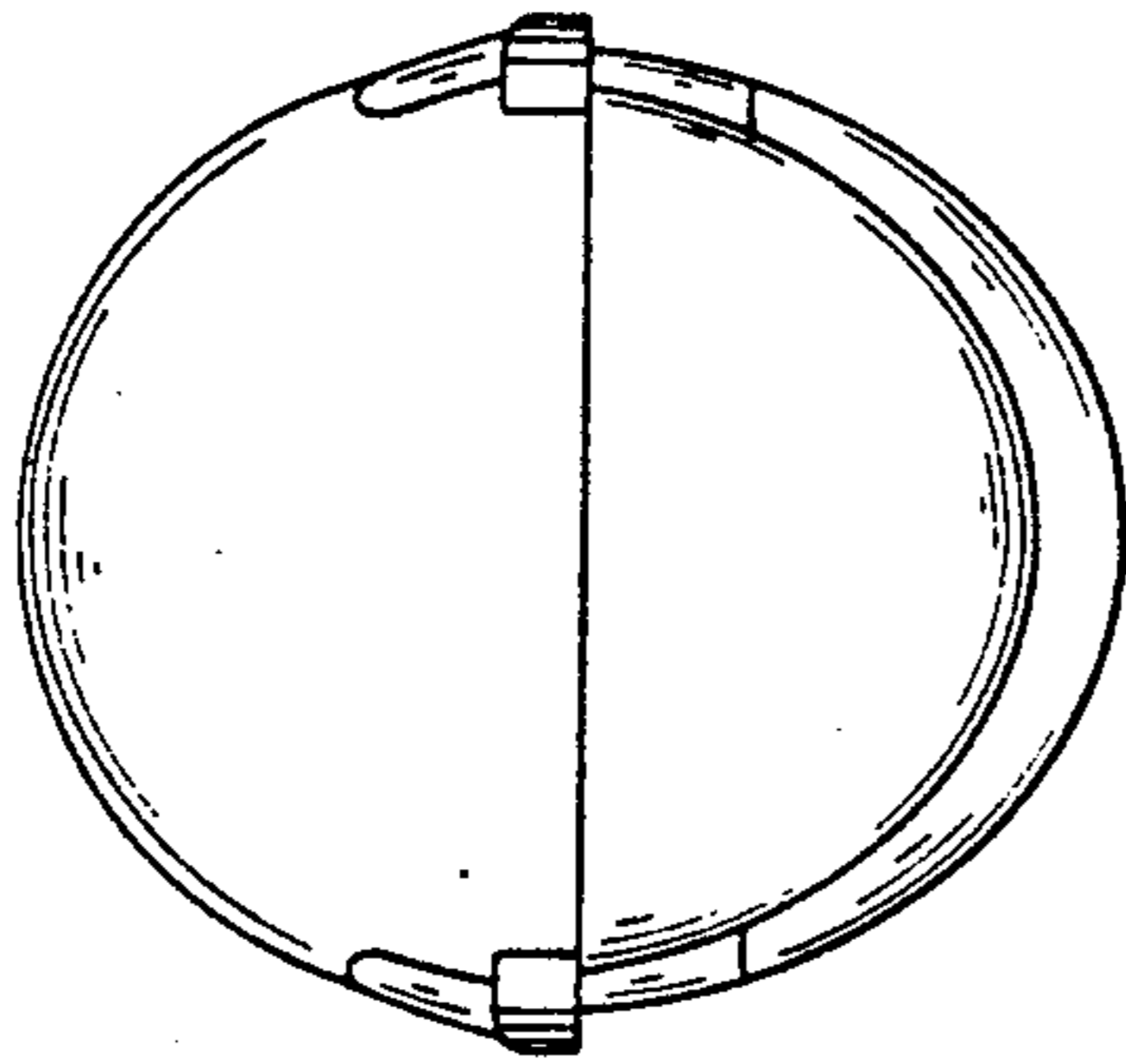

FIG. 6

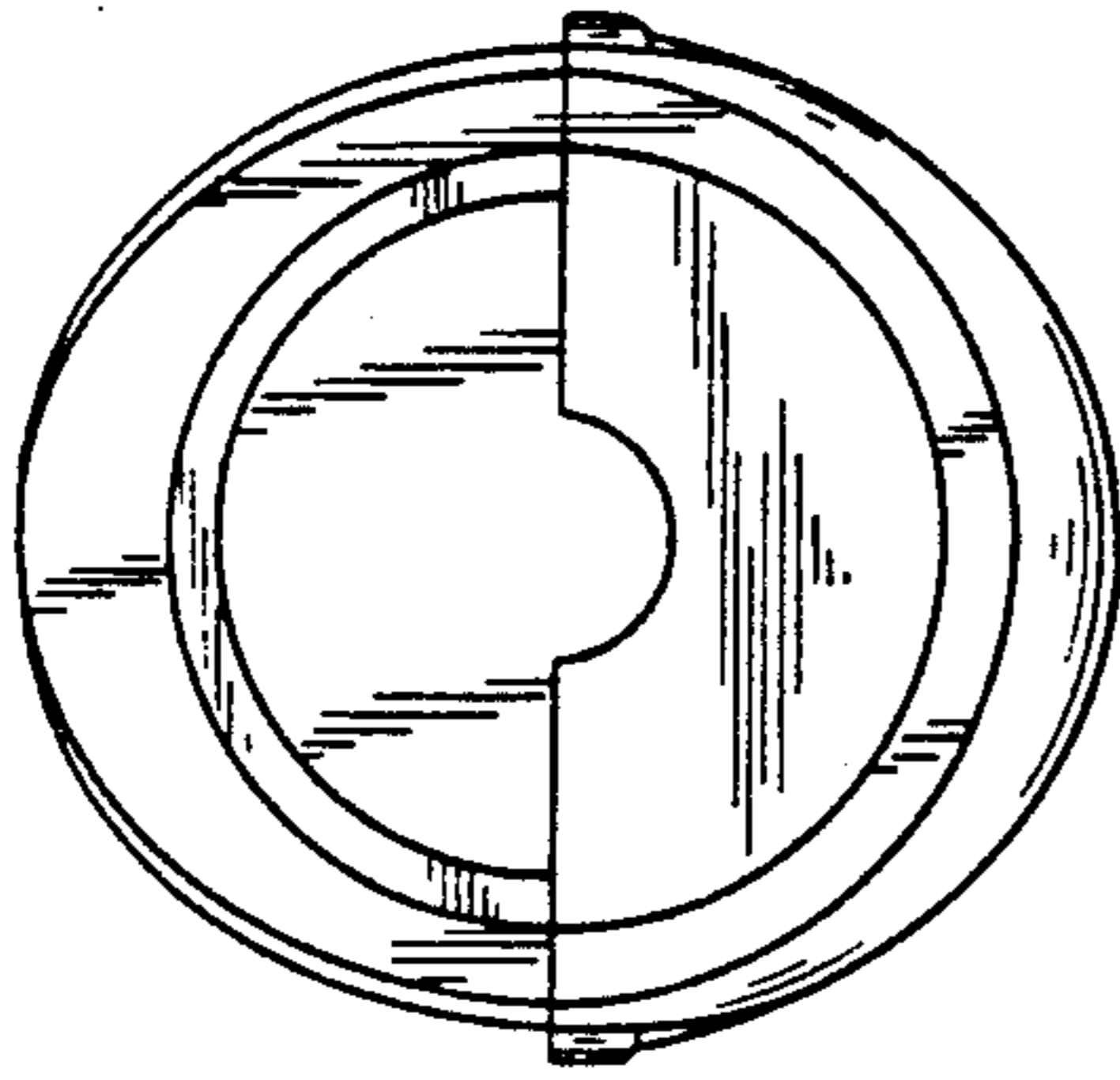

FIG. 4

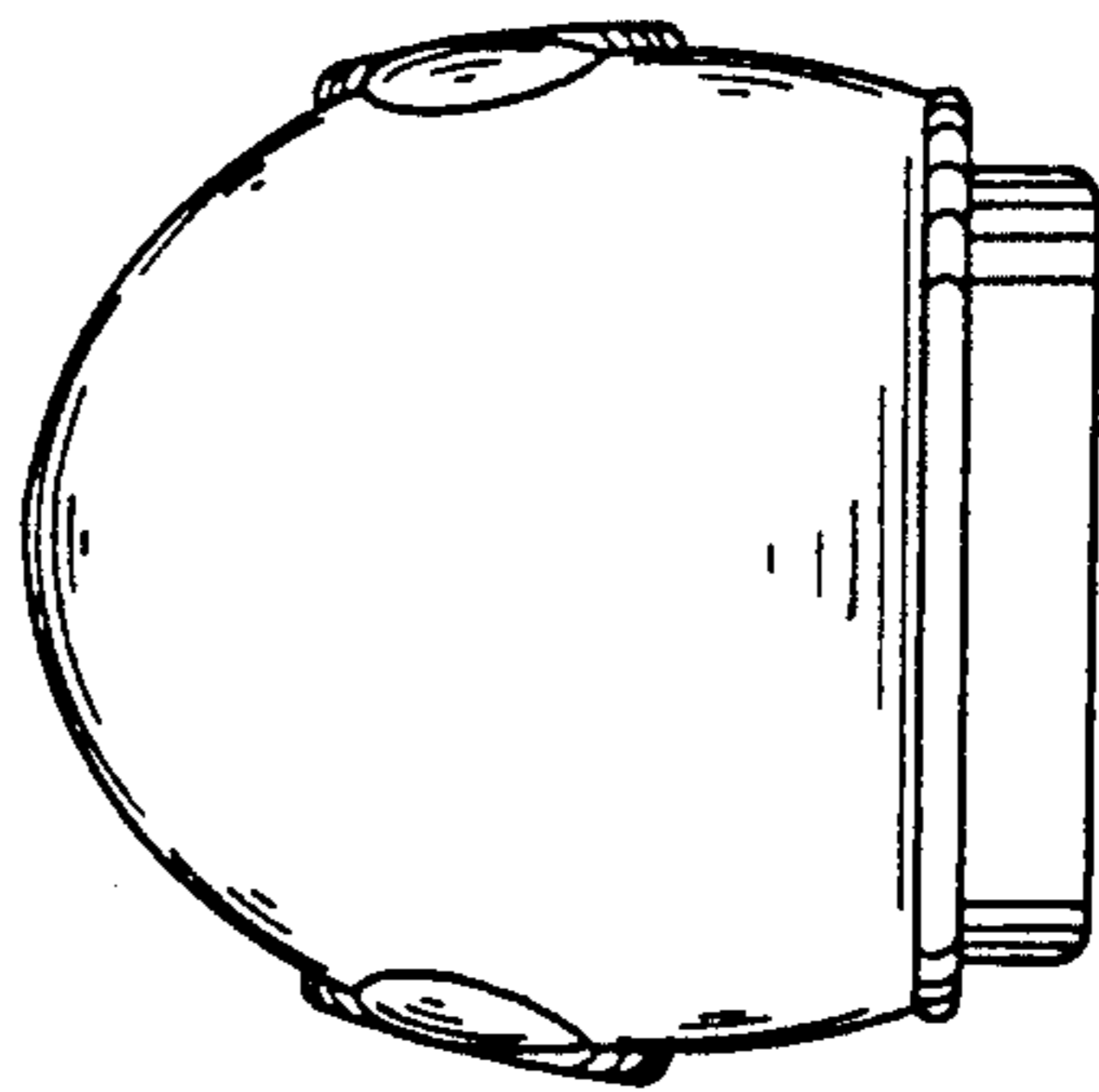

FIG. 7

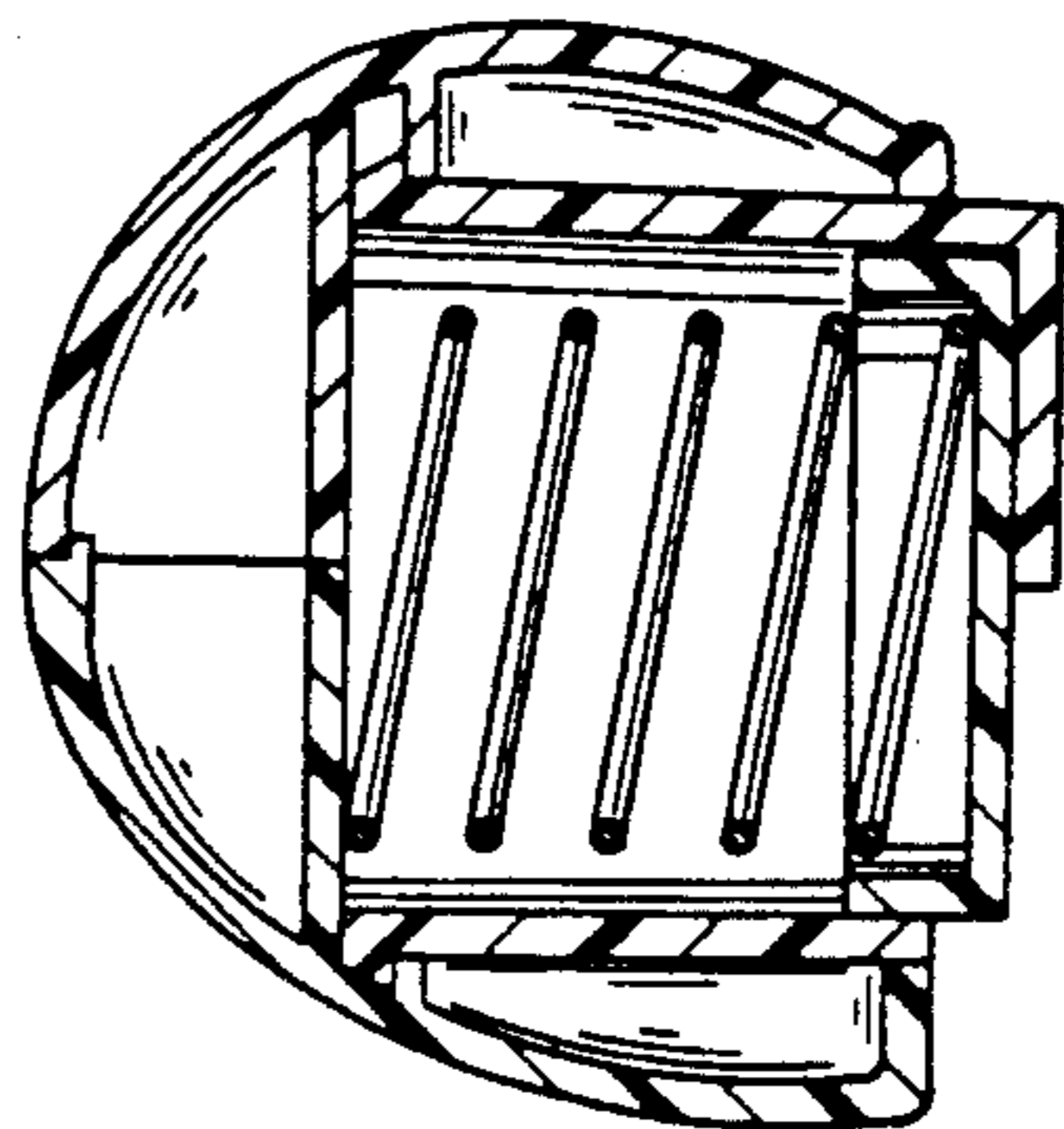

FIG. 3

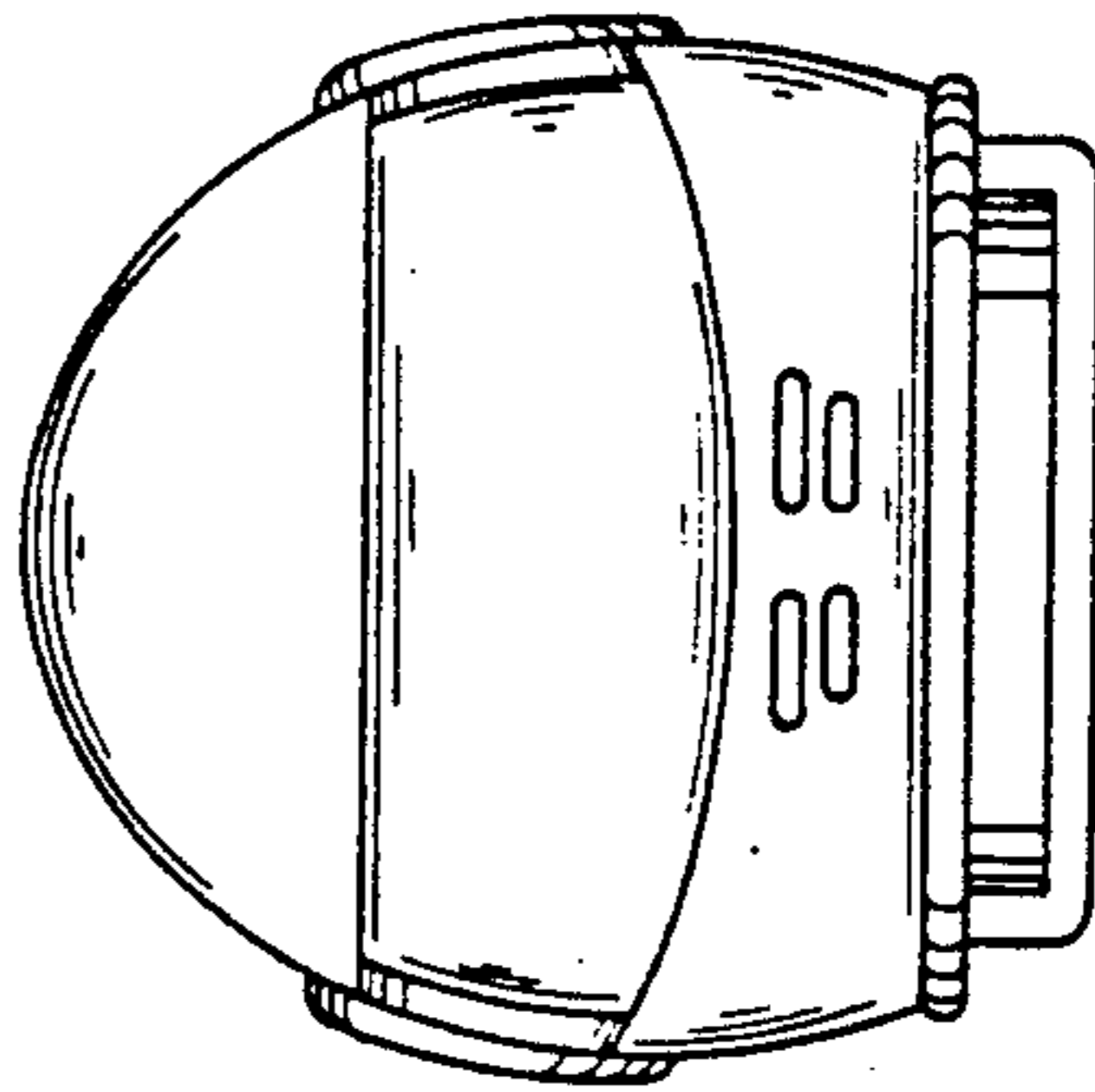

FIG. 2

