

[54] RIBBON CASSETTE

[75] Inventor: Mutsune Urawa, Nagano, Japan

[73] Assignee: Seiko Epson Corporation, Tokyo, Japan

[\*\*] Term: 14 Years

[21] Appl. No.: 446,967

[22] Filed: Dec. 6, 1989

[30] Foreign Application Priority Data

Jun. 26, 1989 [JP] Japan ..... 1-023539

[52] U.S. Cl. .... D18/12; D18/22

[58] Field of Search ..... D18/12, 22, 99; D14/11; 400/194, 195, 196, 196.1, 207, 208

[56] References Cited

U.S. PATENT DOCUMENTS

- D. 275,499 9/1984 Akazawa ..... D18/12
- 4,801,215 1/1989 Paffhausen et al. .... 400/208 X
- 4,850,725 7/1989 Walker et al. .... 400/196.1 X

FOREIGN PATENT DOCUMENTS

- 3446057 6/1986 Fed. Rep. of Germany ..... 400/195
- 0126181 7/1983 Japan ..... 400/208
- 0010480 1/1986 Japan ..... 400/208

Primary Examiner—Nelson C. Holtje  
Assistant Examiner—Caron D. Veynar  
Attorney, Agent, or Firm—Blum & Kaplan

[57] CLAIM

The ornamental design for ribbon cassette, as shown and described.

DESCRIPTION

FIG. 1 is a front elevational view of a ribbon cassette showing my new design;  
FIG. 2 is a rear elevational view thereof;  
FIG. 3 is a top plan view thereof;  
FIG. 4 is a bottom plan view thereof;  
FIG. 5 is a left side elevational view thereof;  
FIG. 6 is a right side elevational view thereof; and  
FIG. 7 is a right, top and rear perspective view thereof.

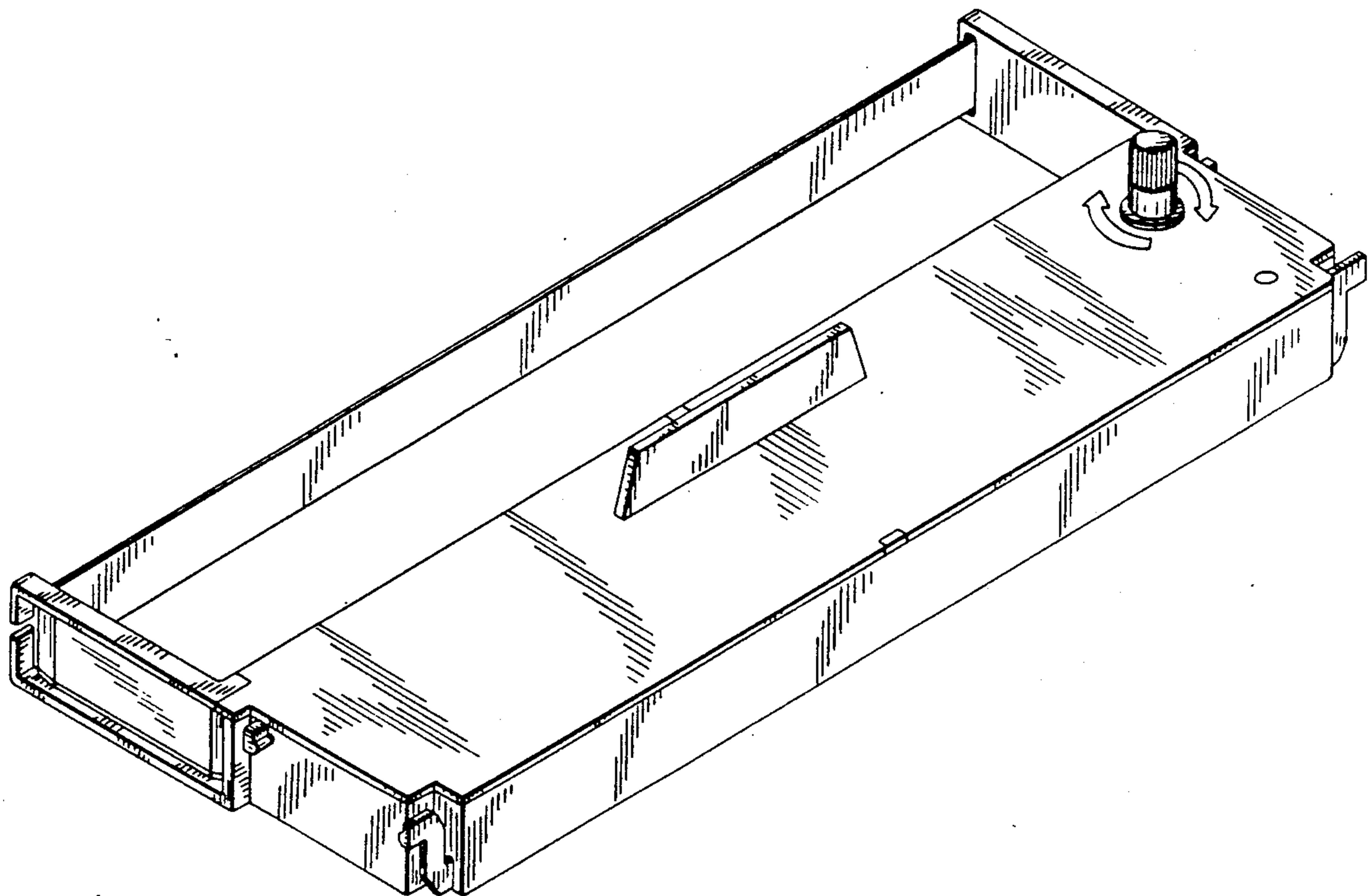

**FIG. 1**

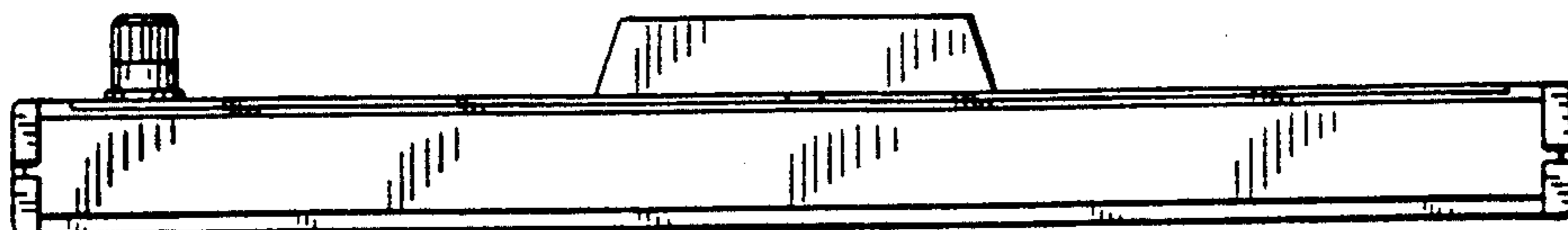

**FIG. 2**

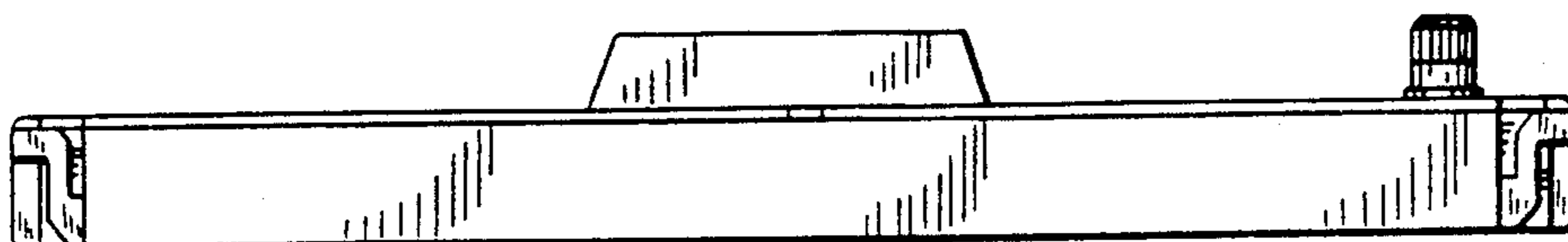

**FIG. 3**

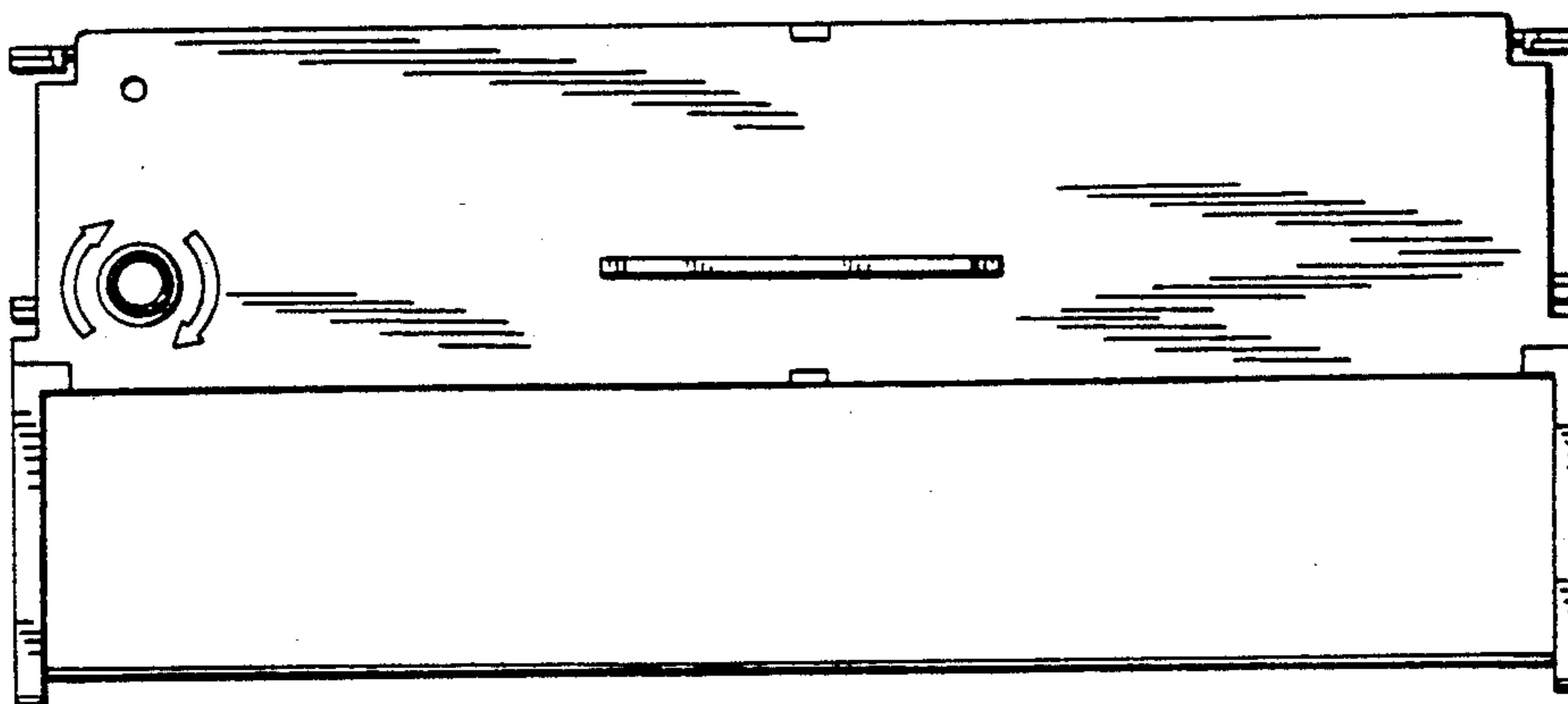

**FIG. 4**

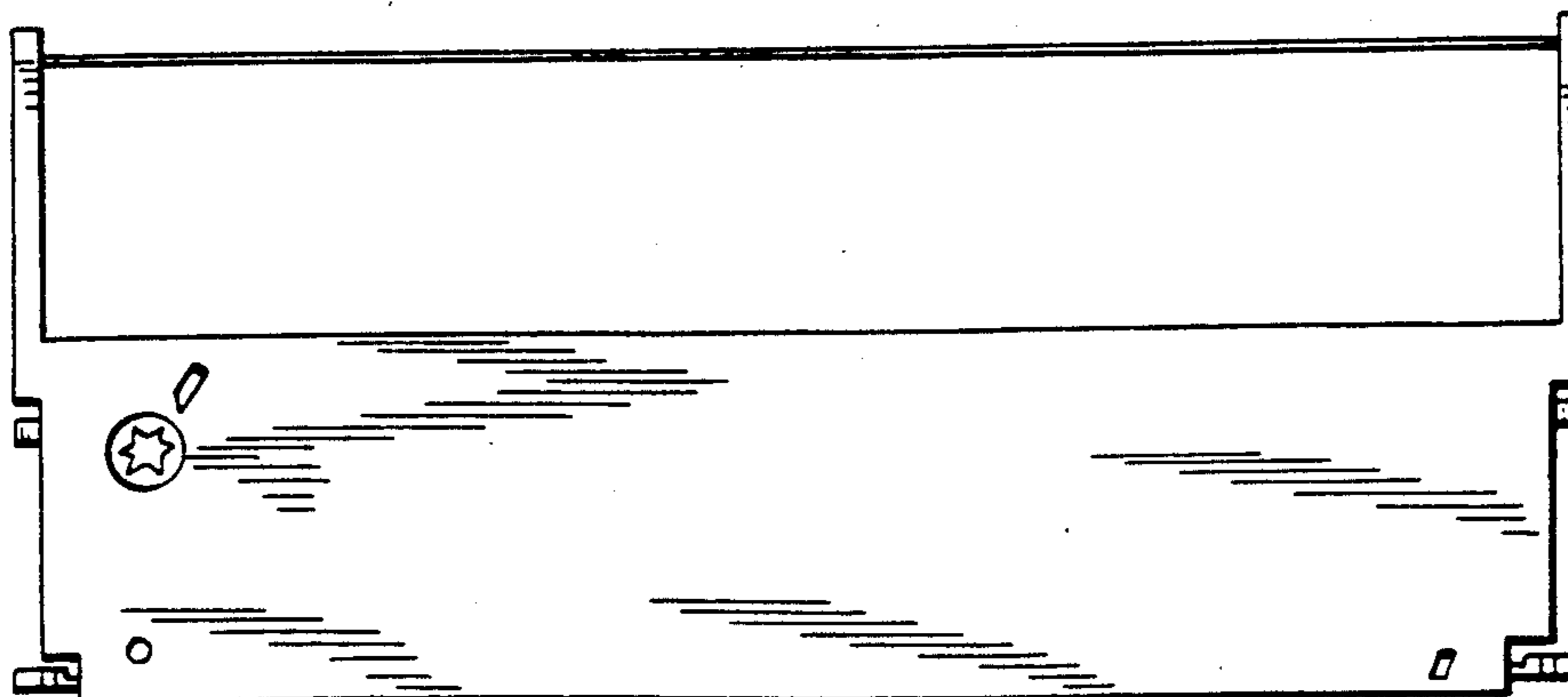

FIG. 5

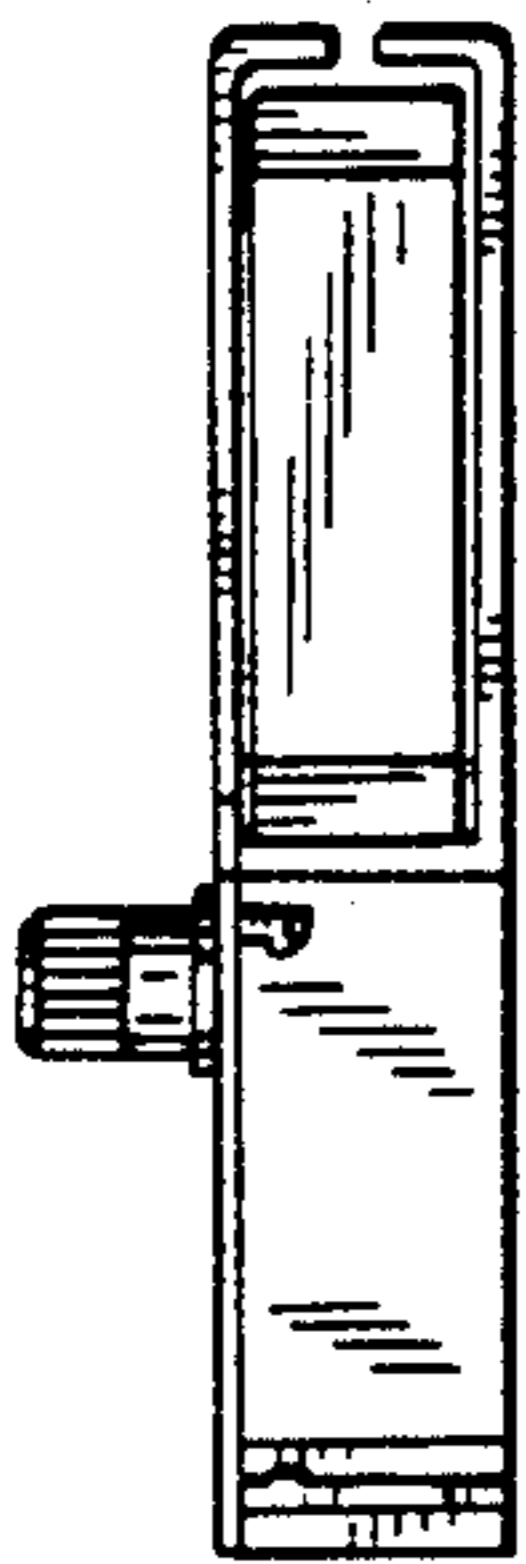

FIG. 6

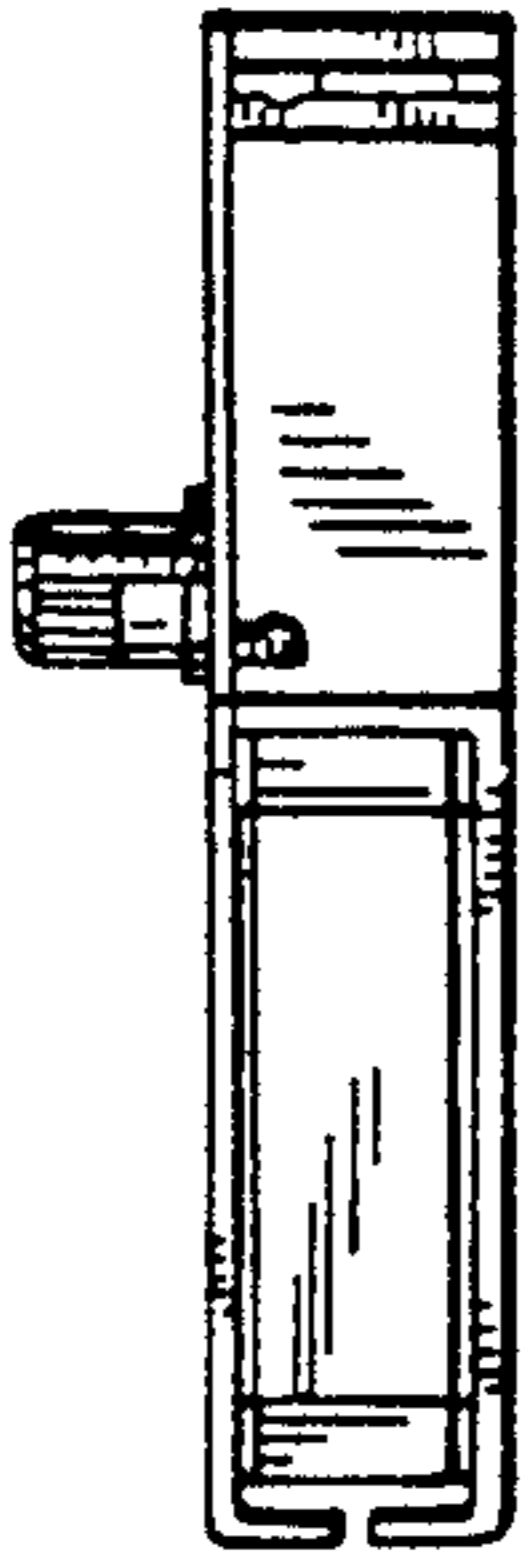

FIG. 7

