

[54] RIBBON CASSETTE

[75] Inventor: Mark J. Lampe, Syracuse, N.Y.
[73] Assignee: Smith Corona Corporation, Cortland, N.Y.
[**] Term: 14 Years
[21] Appl. No.: 464,461
[22] Filed: Jan. 12, 1990
[52] U.S. Cl. D18/12
[58] Field of Search D18/12, 22, 99; D14/121; 400/194, 195, 196, 196.1, 207, 208

3,175,222 3/1965 Nerwin D14/121 X

OTHER PUBLICATIONS

Wang, Information System Ribbons, p. 466.
Diablo Supplies, Printer Ribbons for Diablo and Xerox, p. 465.
Primary Examiner—Nelson C. Holtje
Assistant Examiner—Caron D. Veynar

CLAIM

[57] The ornamental design for a ribbon cassette, as shown and described.

DESCRIPTION

FIG. 1 is a perspective view taken from the top, front and left side of a ribbon cassette showing my new design;
FIG. 2 is a top plan view thereof;
FIG. 3 is a front elevational view thereof;
FIG. 4 is a left side elevational view thereof;
FIG. 5 is a bottom plan view thereof;
FIG. 6 is a rear elevational view thereof; and
FIG. 7 is a right side elevational view thereof.

[56] References Cited

U.S. PATENT DOCUMENTS

- D. 205,807 9/1966 Yamamura D14/121
- D. 245,726 9/1977 Sottsass D14/121 X
- D. 277,193 1/1985 Asahi D18/12
- D. 280,736 9/1985 Schuiling D18/12
- D. 286,057 10/1986 Tamada et al. D18/12
- D. 302,437 7/1989 Altmann et al. D18/12
- D. 307,436 4/1990 Endo et al. D18/12
- 3,157,880 11/1964 Easterly et al. D14/121 X

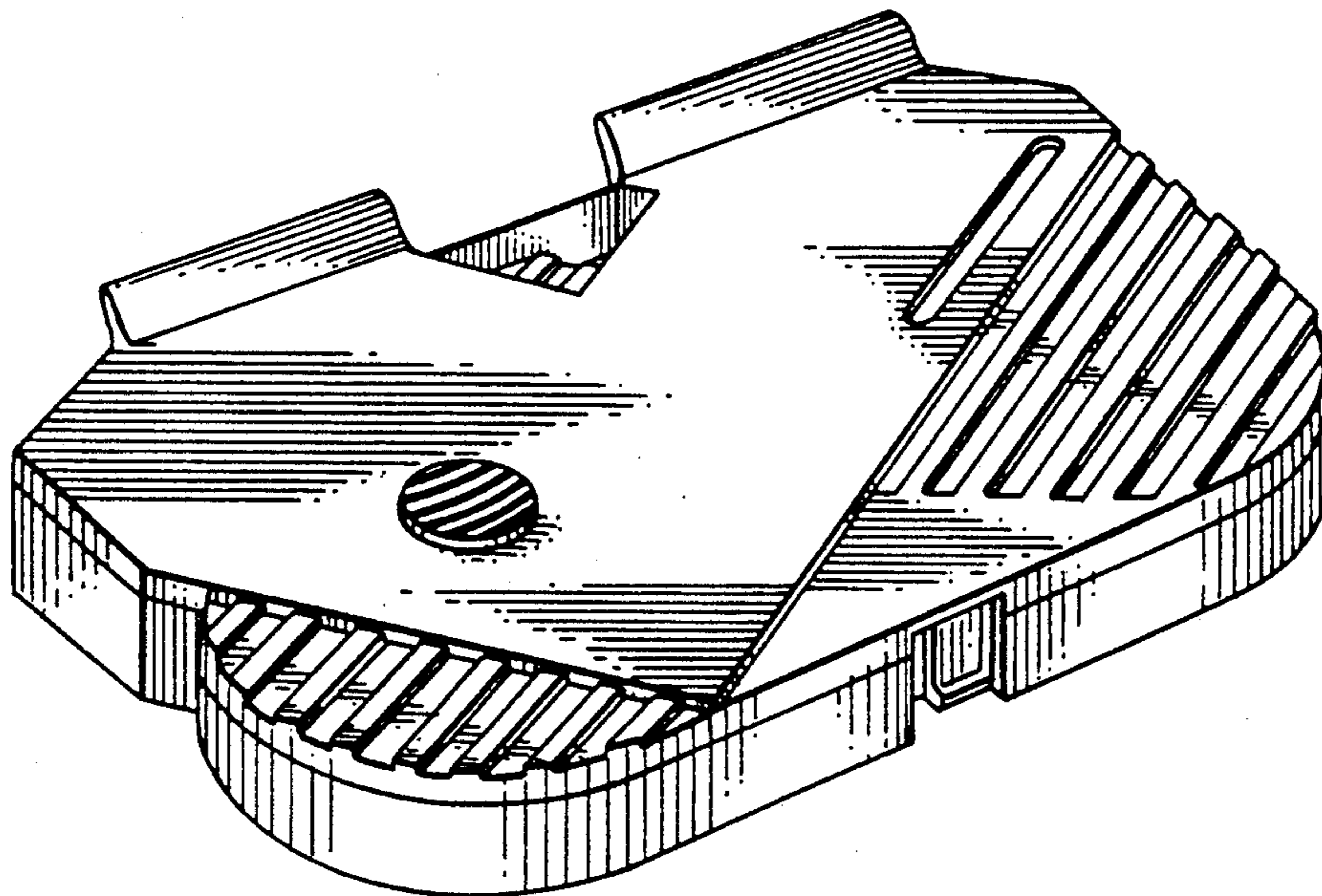

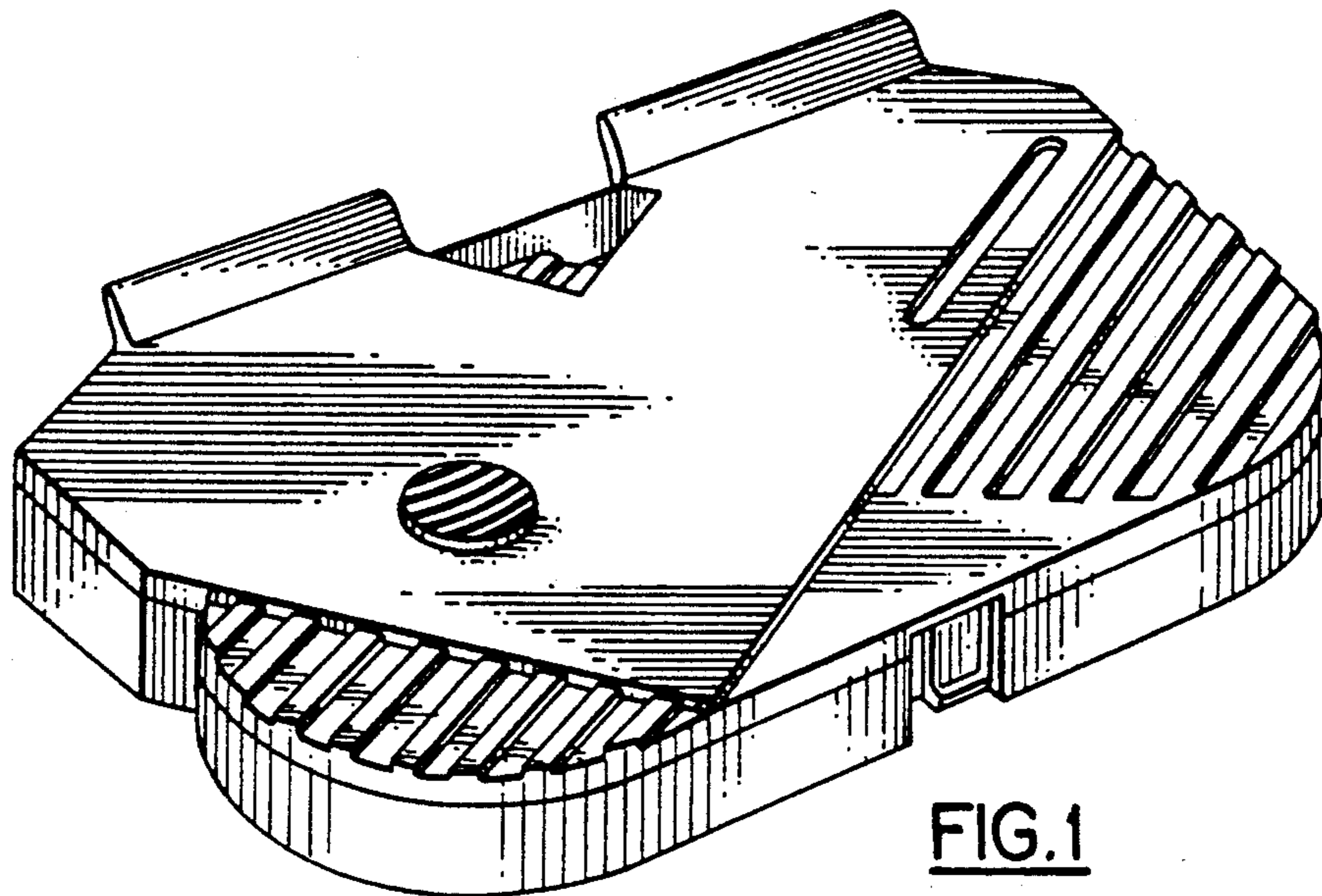

FIG. 1

FIG. 2

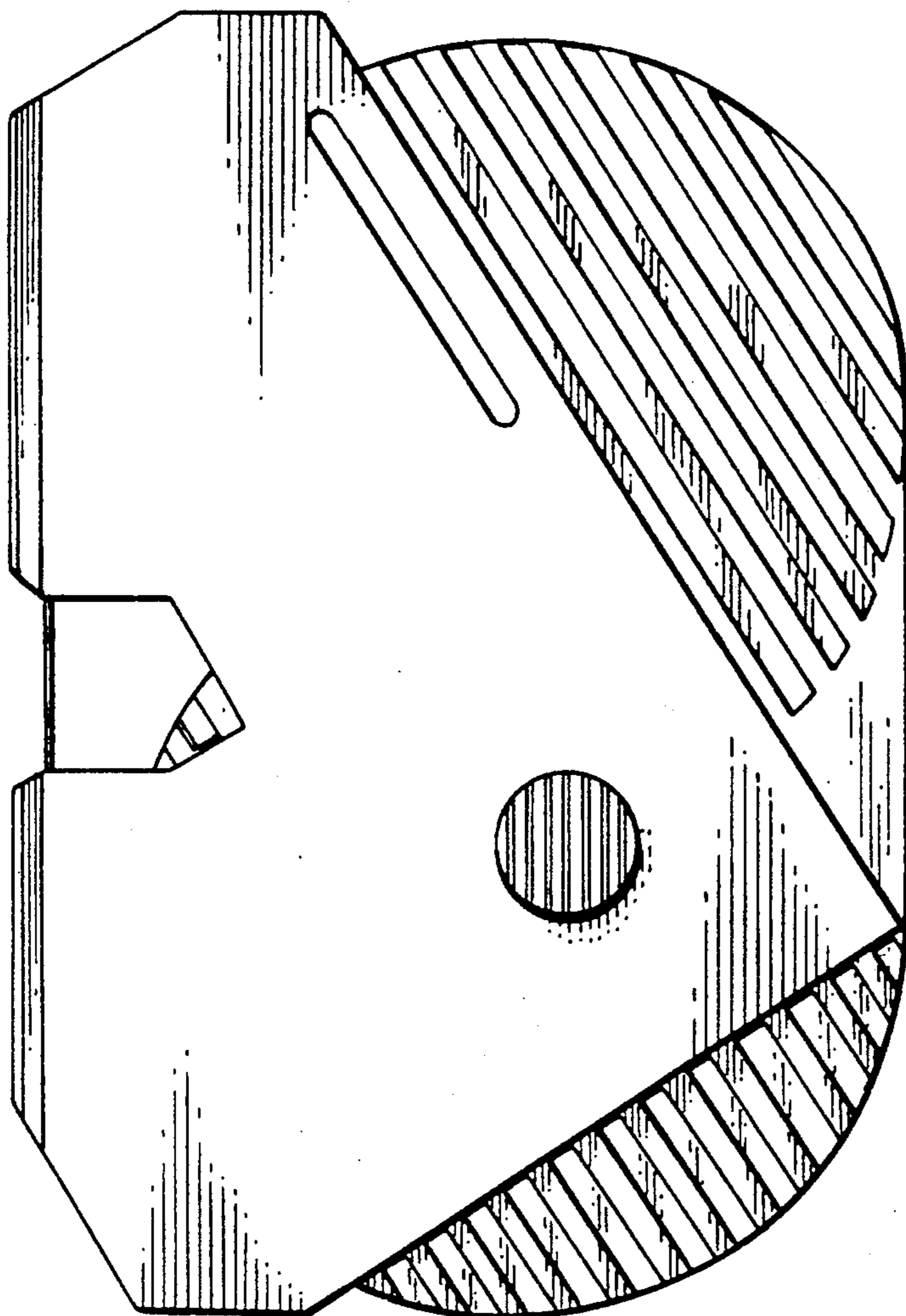

FIG. 3

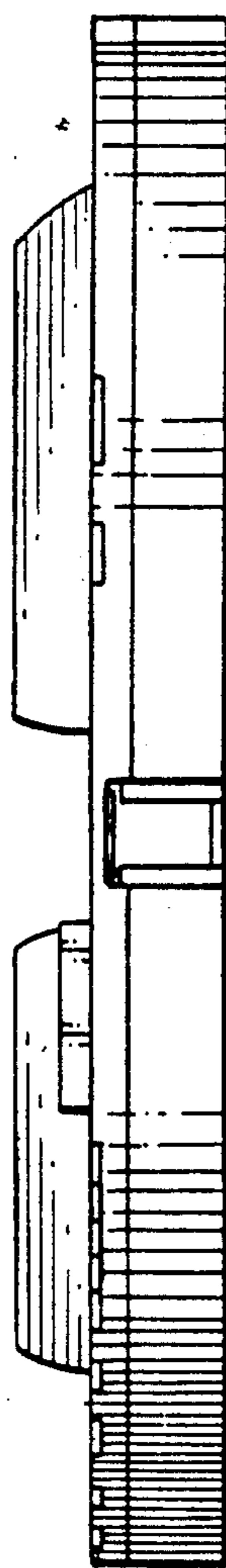

FIG. 4

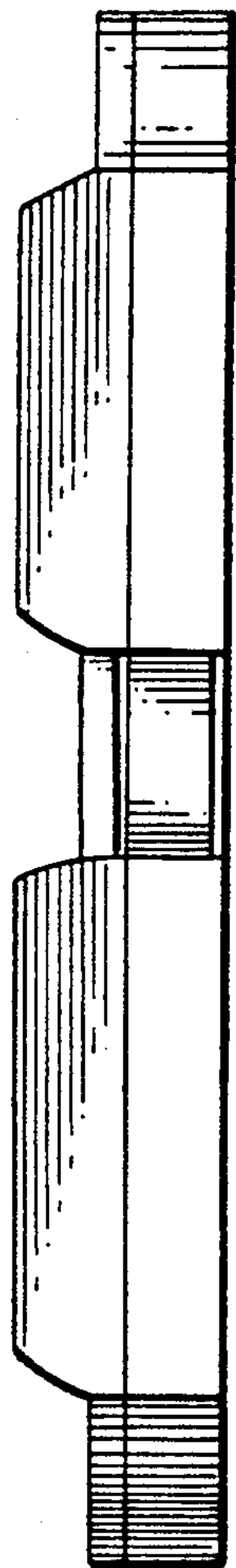
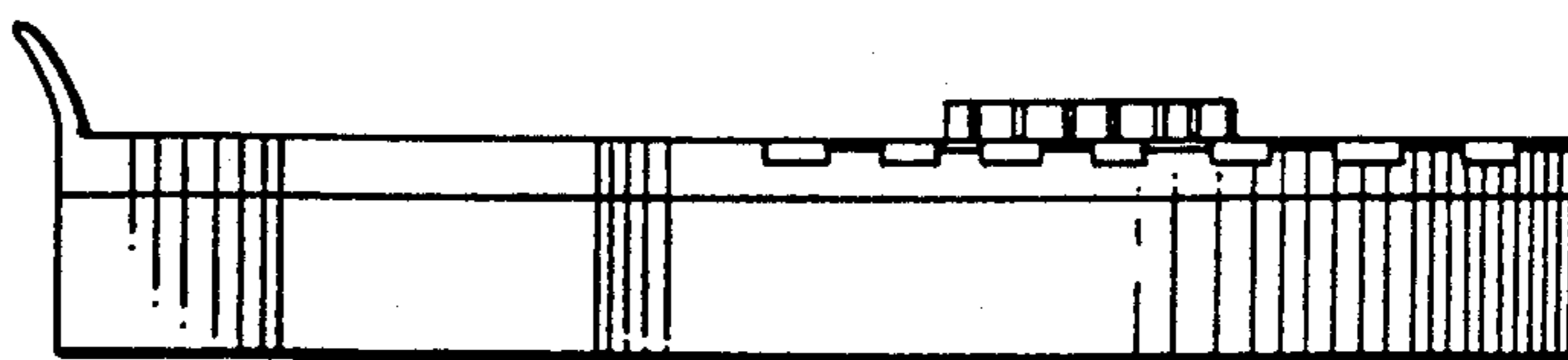

FIG. 6

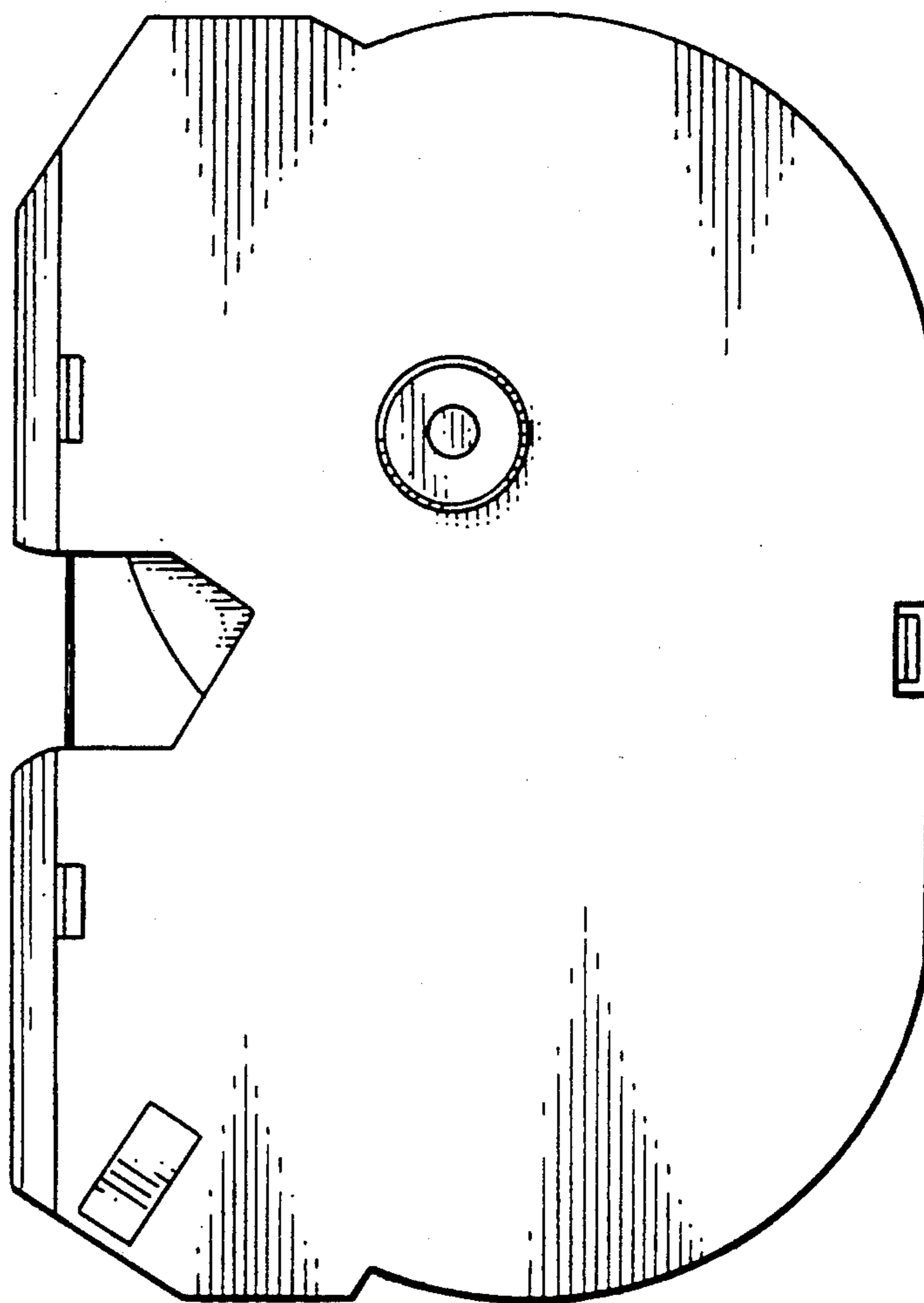

FIG. 5

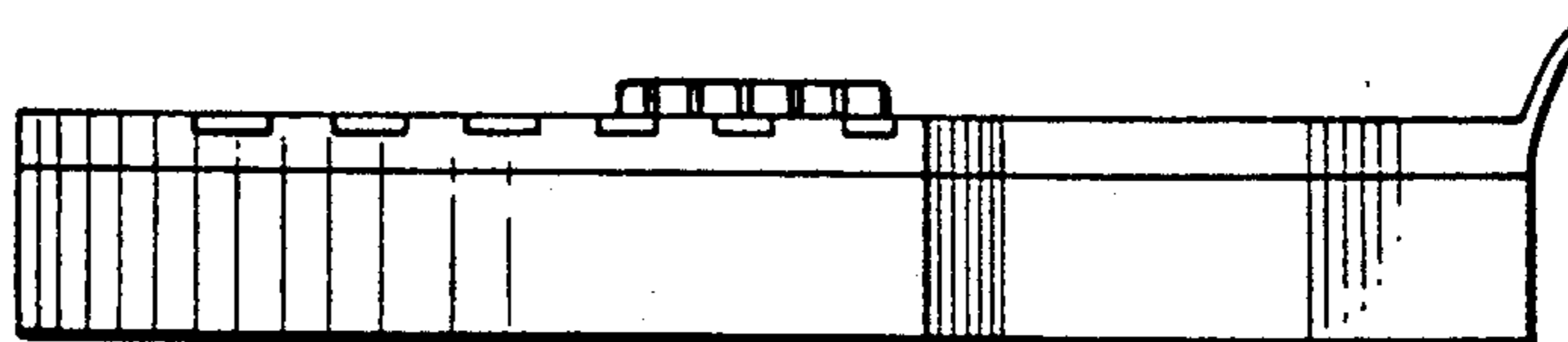

FIG. 7