

[54] **COMBINED BOTTLE AND CAP**
 [75] **Inventor: John Crawford, Mahopac, N.Y.**
 [73] **Assignee: Colgate-Palmolive Company, Piscataway, N.J.**
 [**] **Term: 14 Years**
 [21] **Appl. No.: 433,088**
 [22] **Filed: Nov. 7, 1989**
 [52] **U.S. Cl. D9/367; D9/372; D9/409; D9/412**
 [58] **Field of Search D9/367, 403-413, D9/372, 435, 446; 215/1 R, 1 C**

D. 305,505 1/1990 Kunesh D9/413

FOREIGN PATENT DOCUMENTS

4770/87 6/1987 Rep. of Korea .
 4394/90 4/1990 Rep. of Korea .

OTHER PUBLICATIONS

Cosmetics and Toiletries, Sep., 1984, p. 70, Atune Shampoo bottle.

Primary Examiner—Feifer Melvin B.
Assistant Examiner—Lucy Lieberman
Attorney, Agent, or Firm—Richard J. Ancel; Robert C. Sullivan; Murray M. Grill

CLAIM

The ornamental design for a combined bottle and cap, as shown and described.

References Cited
U.S. PATENT DOCUMENTS

D. 10,407	1/1878	Atwater	D9/372
D. 85,925	1/1932	Fuerst	D9/412
D. 105,797	8/1937	Kihn	D9/372
D. 109,908	5/1938	Coleman	D9/409
D. 129,158	8/1941	Dexter	D9/405
D. 189,631	1/1961	Vanderhyde	D9/409
D. 202,933	11/1965	Platte	D9/409
D. 263,373	3/1982	Howard et al.	D9/403
D. 274,309	6/1984	Aldrich, III	D9/403
D. 300,119	3/1989	Pacquin	D9/412

DESCRIPTION

FIG. 1 is a front elevation of a combined bottle and a cap embodying my new design;
 FIG. 2 is a rear elevation thereof;
 FIG. 3 is a left side elevation thereof;
 FIG. 4 is a right side elevation thereof;
 FIG. 5 is a top plan view thereof;
 FIG. 6 is a bottom plan view thereof; and
 FIG. 7 is a top, side, and rear perspective view thereof.

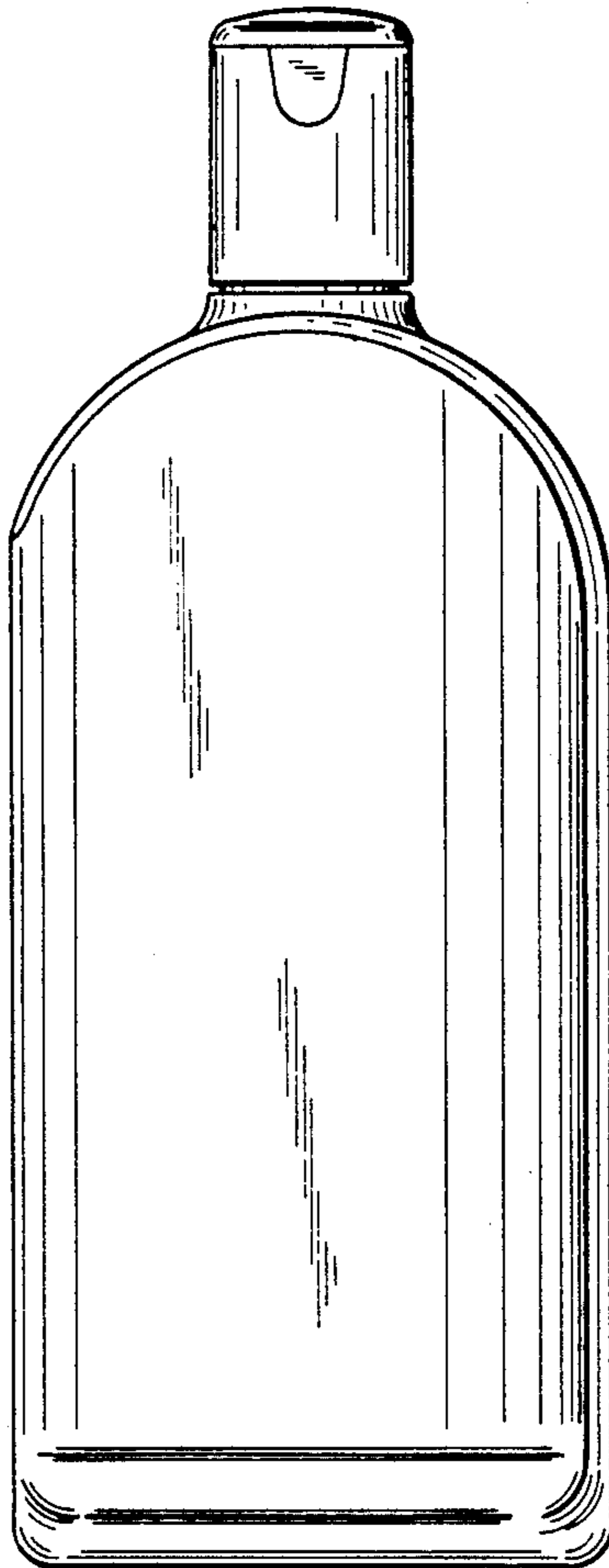

FIG. 1

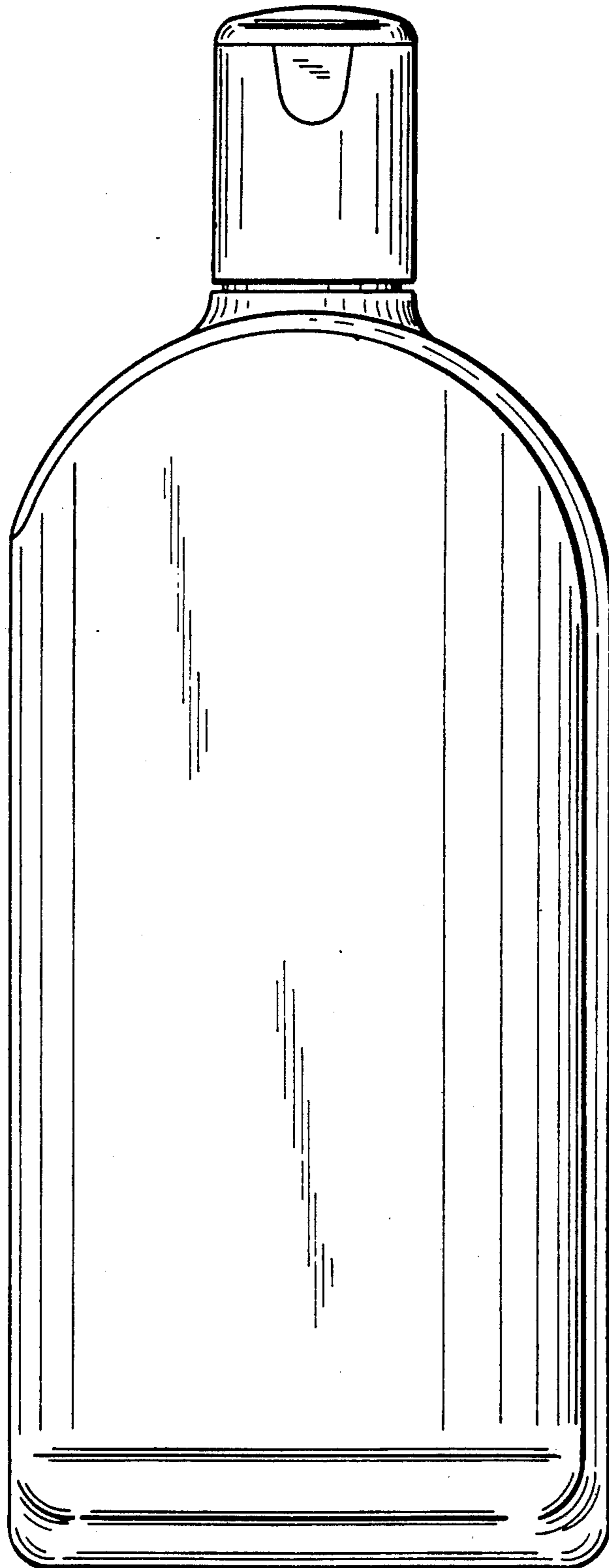

FIG. 2

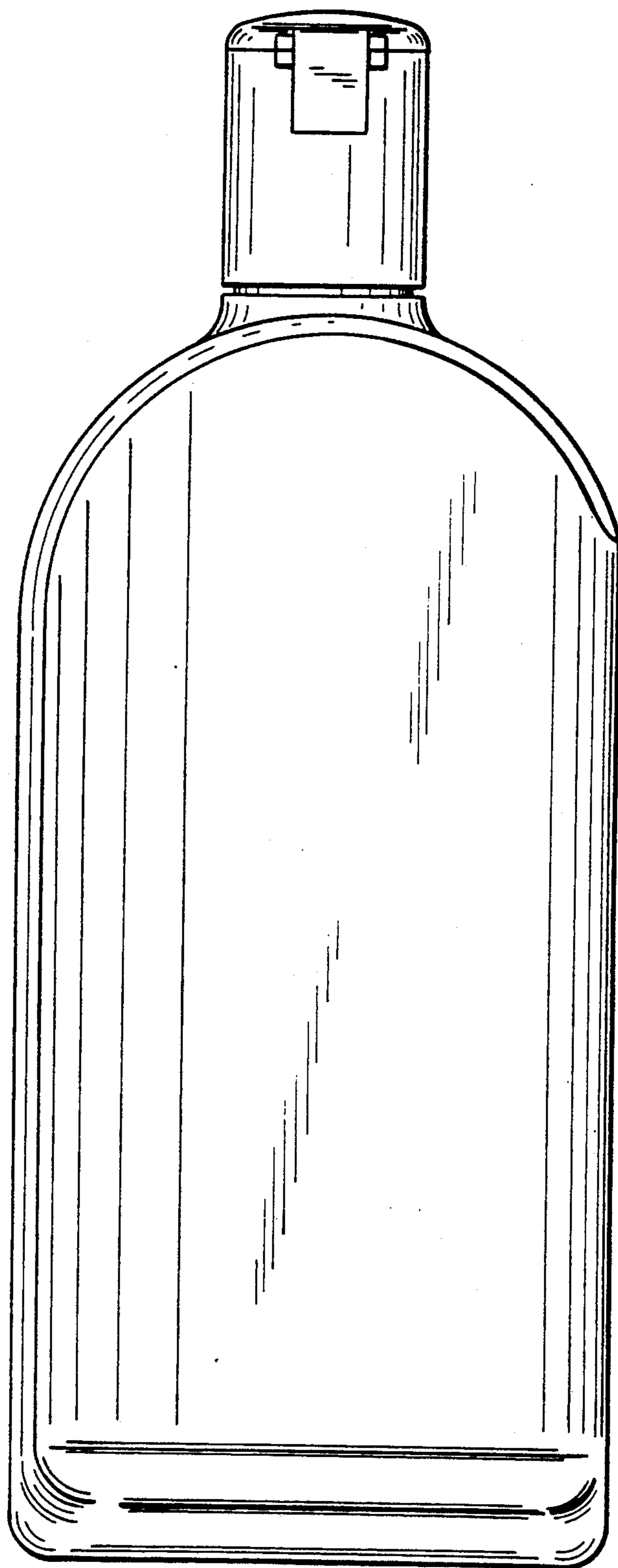

FIG. 3

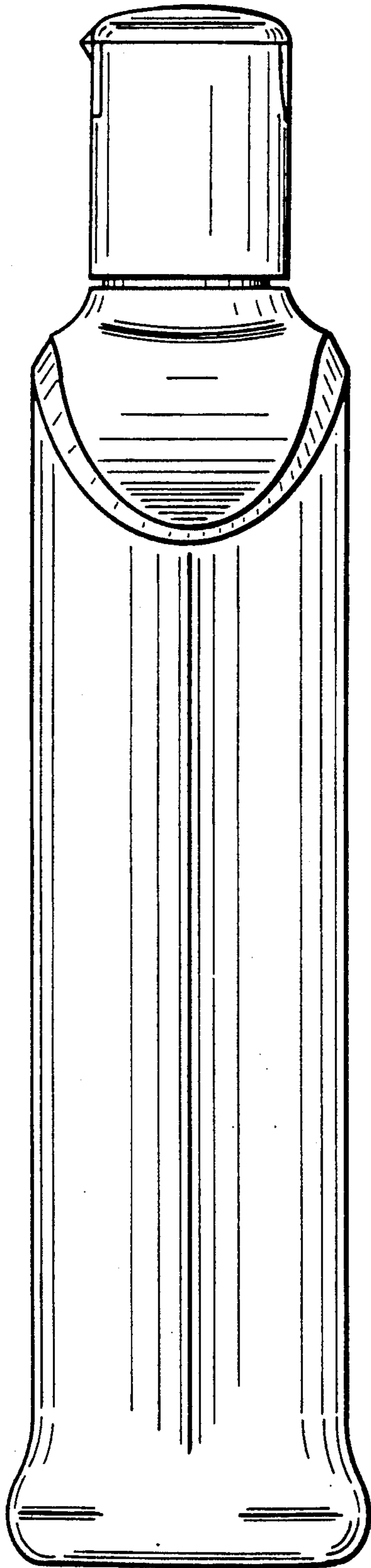

FIG. 4

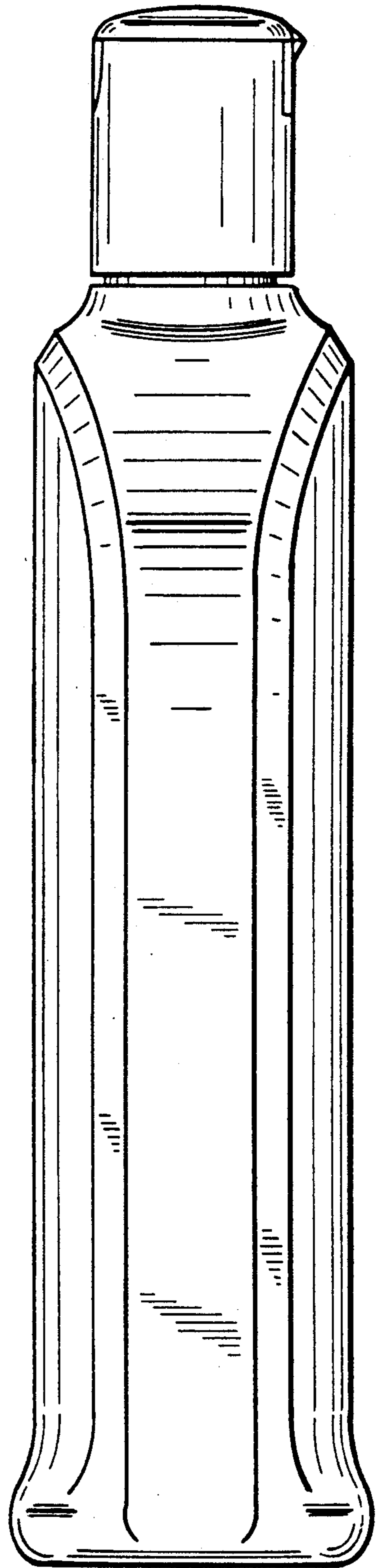

FIG. 5

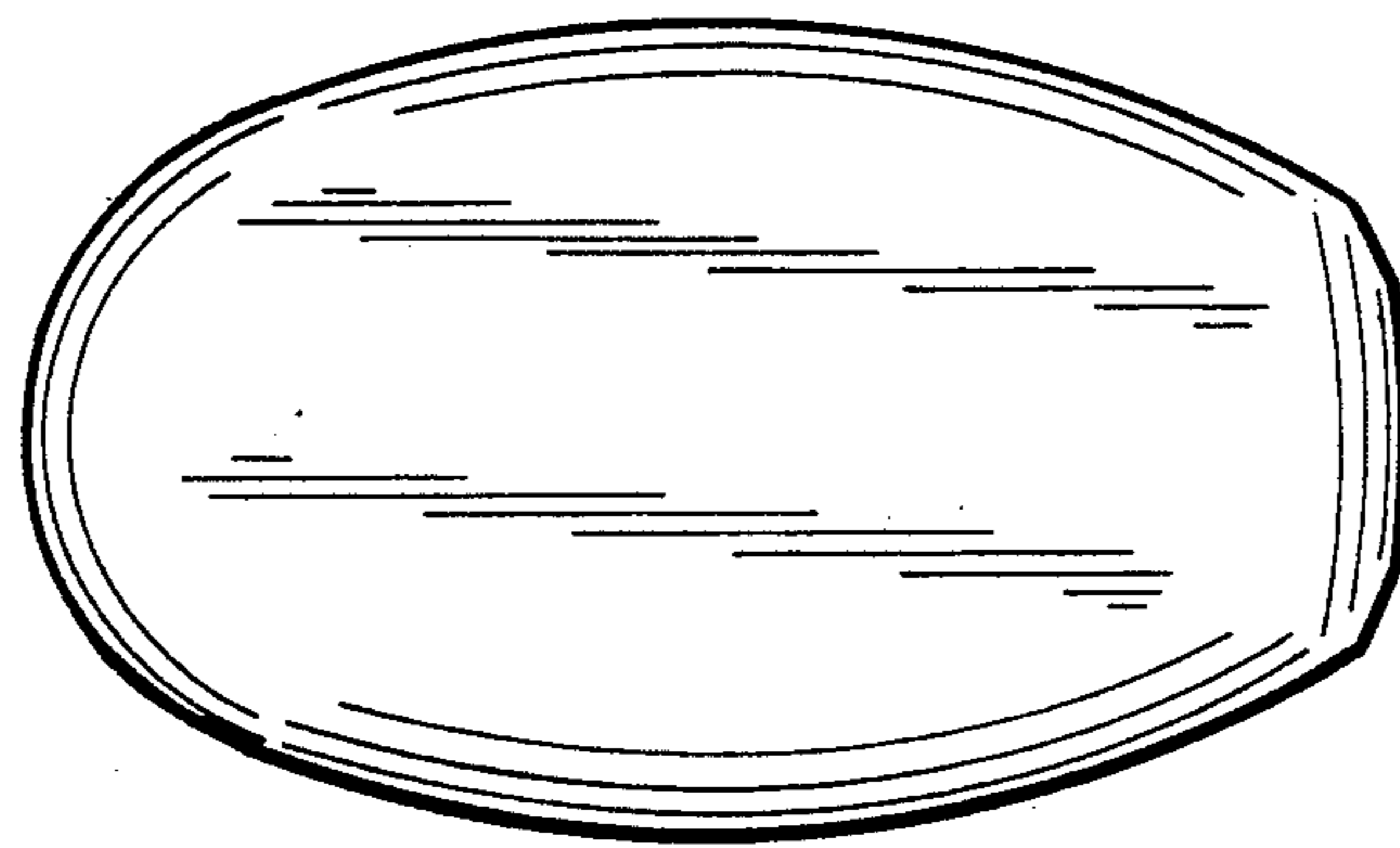
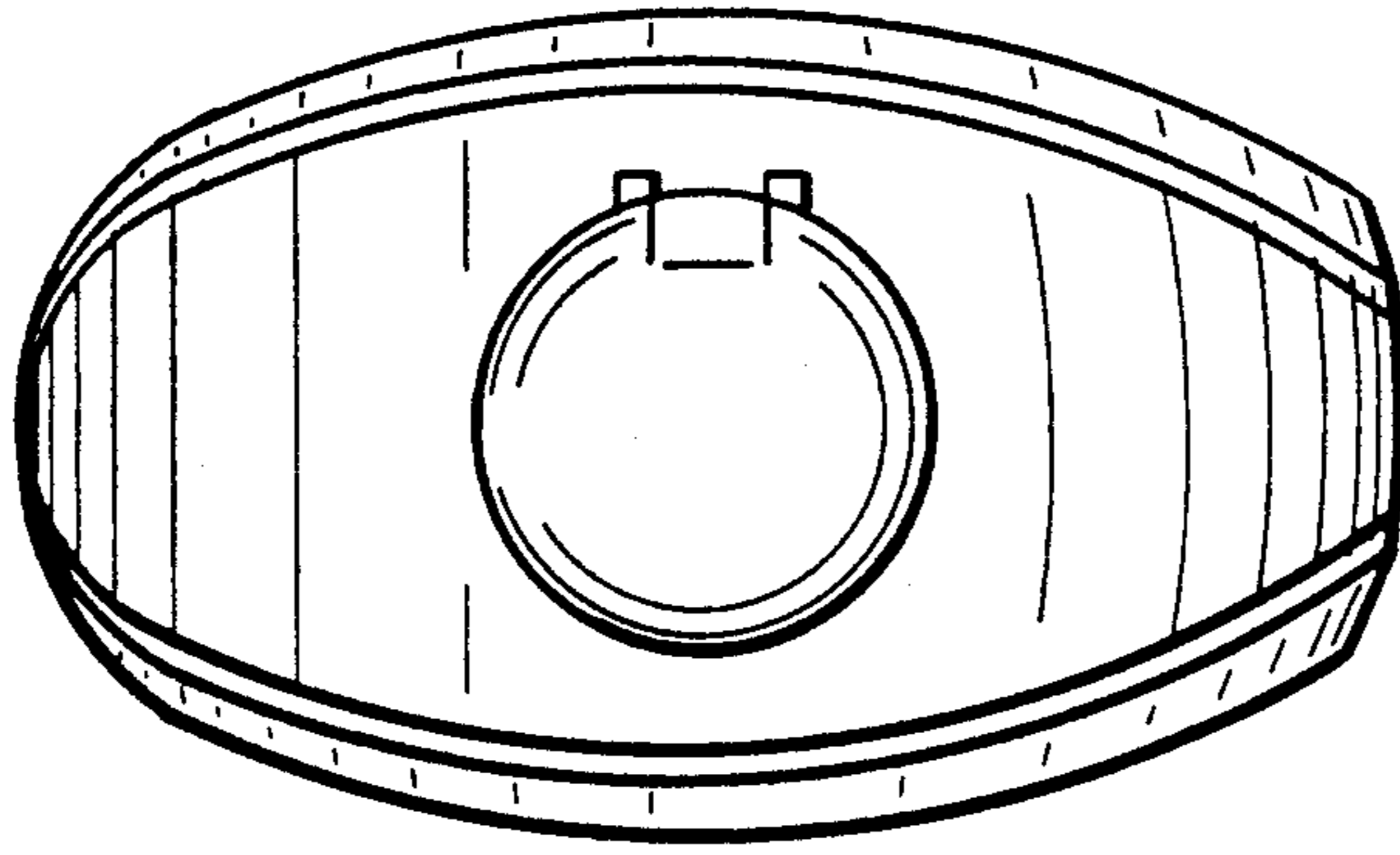

FIG. 6

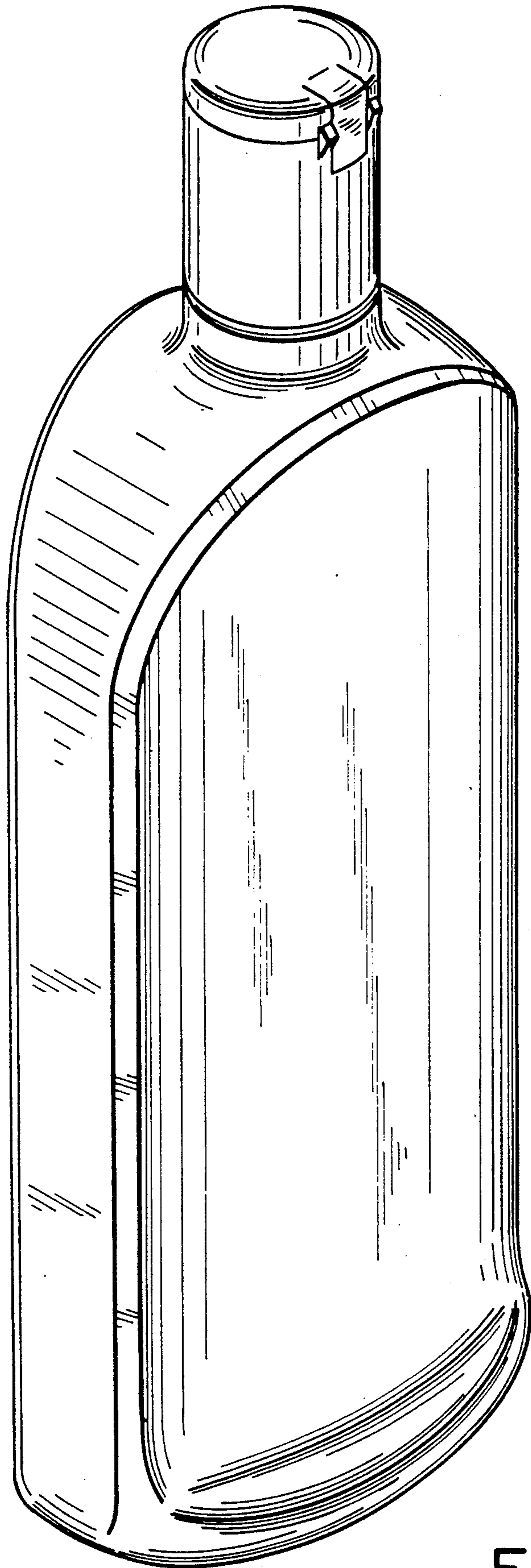

FIG. 7