

[54] **I.V. FLOW REGULATOR**
 [75] Inventors: **Birendra K. Lal**, Glendale Heights;
Steven K. Neuenfeldt, Vernon Hills;
Mark A. Hoekwater, Mundelein, all
 of Ill.
 [73] Assignee: **Baxter International Inc.**, Deerfield,
 Ill.
 [**] Term: **14 Years**
 [21] Appl. No.: **353,375**
 [22] Filed: **May 17, 1989**
 [52] U.S. Cl. **D24/129**
 [58] Field of Search D24/53, 51; 604/246,
 604/244, 250, 252, 251, 249, 247, 298, 248, 126,
 32, 33, 905; 137/501, 445, 505, 504, 503;
 251/205, 208, 209; 138/37, 46

4,343,305 8/1982 Bron .
 4,396,010 8/1983 Becker 604/252 X
 4,428,397 1/1984 Bron .
 4,468,225 8/1984 Tcheraz .
 4,515,588 5/1985 Amendolia .
 4,552,336 11/1985 Pastrone .
 4,613,325 9/1986 Abrams 604/246 X
 4,703,775 11/1987 Pastrone .
 4,738,665 4/1988 Shepard .
 4,856,755 8/1989 Clarke 604/250 X

FOREIGN PATENT DOCUMENTS

2735955 2/1979 Fed. Rep. of Germany .
 374476 11/1971 U.S.S.R. .
 2167161 11/1988 United Kingdom .

OTHER PUBLICATIONS

Trade Publication (Using Special Equipment) for the nursing profession, which discloses a "Sorenson Dial-A-Flow" regulator.
 Master Medical Corporation Catalog 1988/89 disclosing "In Precision Gravity Intravenous Control Products".
 "The Arm-A-Flow I.V. Flow Regulator"; Armour Pharmaceutical Company; 4/85, Product Brochure.

Primary Examiner—Stella Reid
Attorney, Agent, or Firm—Paul C. Flattery; Amy L. H. Rockwell; Paul E. Schaafsma

[56] **References Cited**
U.S. PATENT DOCUMENTS

D. 263,335 3/1982 Bujan .
 D. 266,737 11/1982 D'Alo D24/53 X
 D. 269,545 6/1983 Cannon .
 D. 274,355 6/1984 Cannon .
 D. 275,989 10/1984 Robinson .
 D. 275,990 10/1984 Robinson .
 D. 275,991 10/1984 Robinson .
 3,523,559 8/1970 Gibson .
 3,807,430 4/1974 Keller .
 3,812,876 5/1974 Krieter .
 3,877,428 4/1975 Seagle et al. .
 3,886,968 6/1975 Murrell .
 3,939,832 2/1976 Miller 604/246 X
 4,011,893 3/1977 Bentley .
 4,142,523 3/1979 Stegeman .
 4,142,524 3/1979 Jassawalla et al. .
 4,183,499 1/1980 Swartz et al. .
 4,209,133 6/1980 Mehoudar .
 4,294,246 10/1981 Aslanian et al. 604/33
 4,299,220 11/1981 Dorman .
 4,317,473 5/1982 Gaydos .

[57] **CLAIM**
 The ornamental design for an I.V. flow regulator, as shown and described.

DESCRIPTION

FIG. 1 is a top perspective view of an I.V. flow regulator, showing our new design;
 FIG. 2 is a top plan view thereof;
 FIG. 3 is a side perspective view thereof;
 FIG. 4 is a bottom plan view thereof;
 FIG. 5 is a front side elevational view thereof; and,
 FIG. 6 is a back side elevational view thereof.

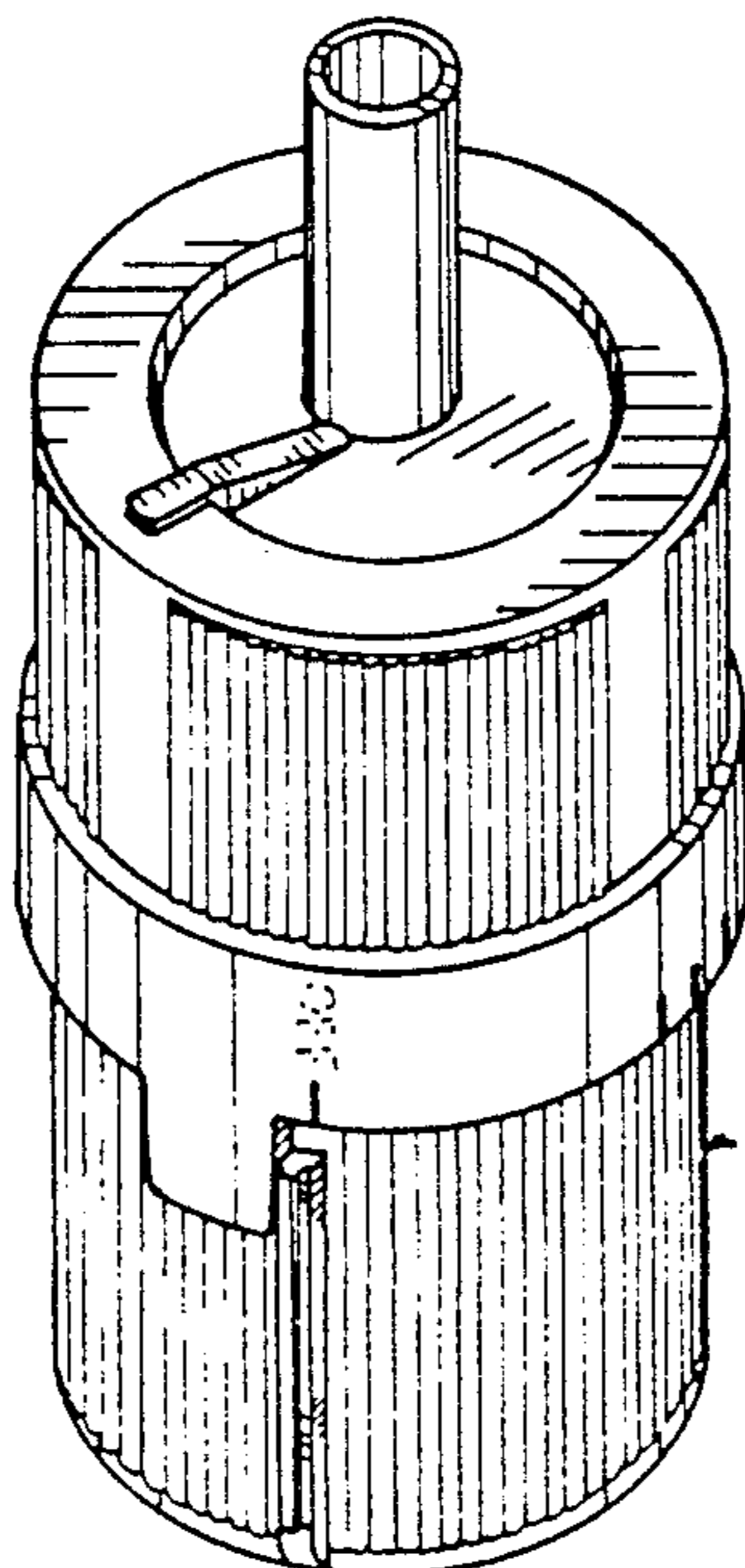

FIG. 1

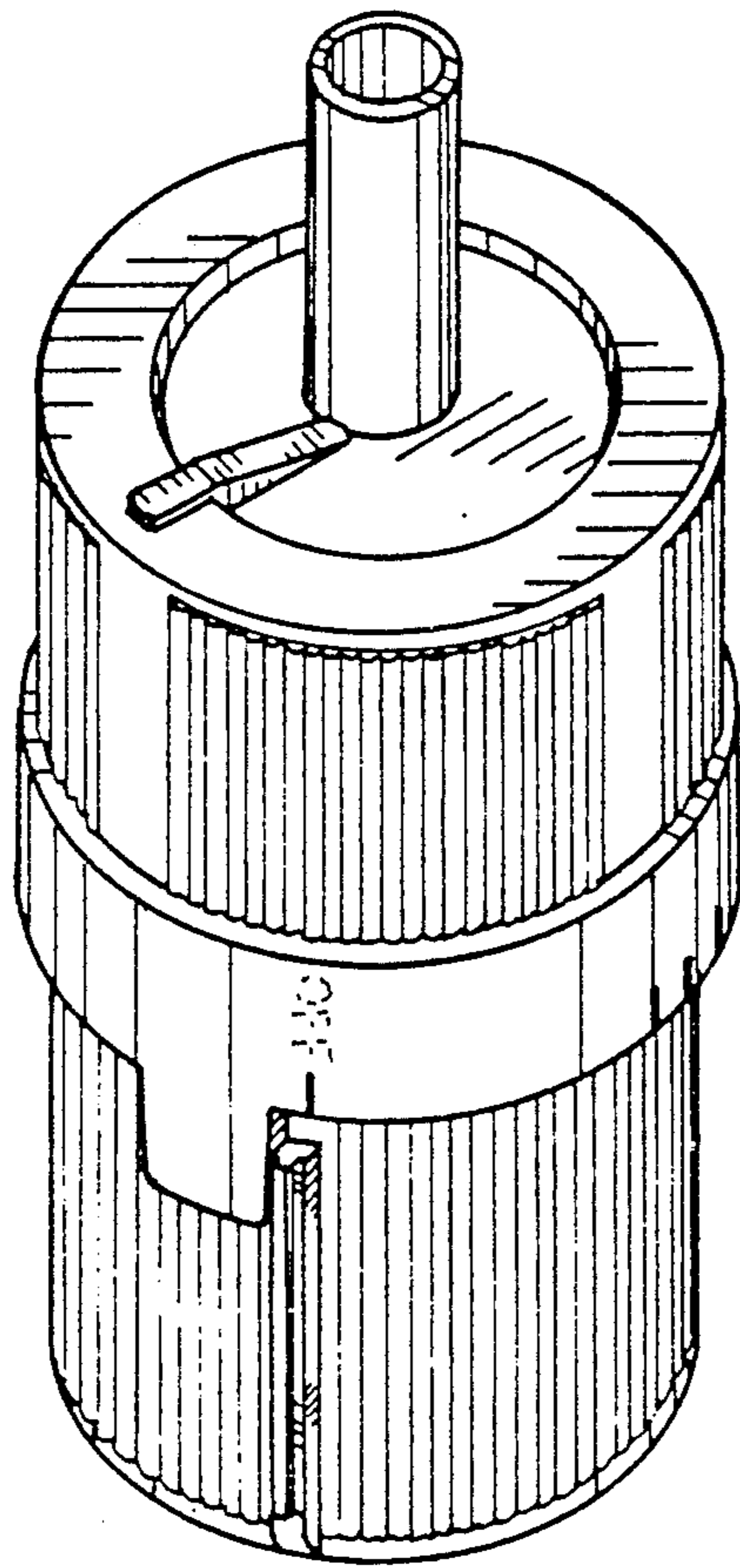

FIG. 2

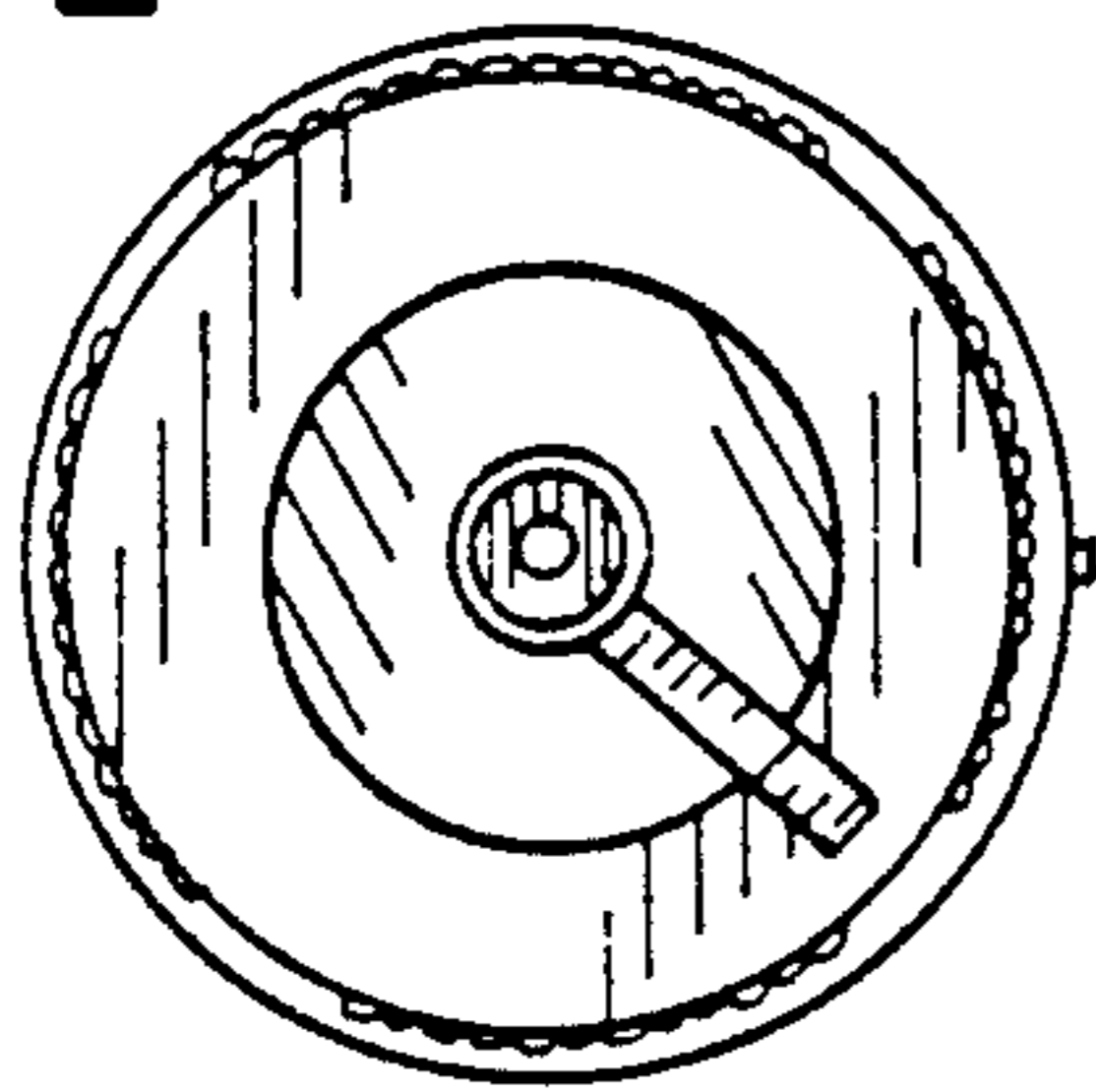

FIG. 3

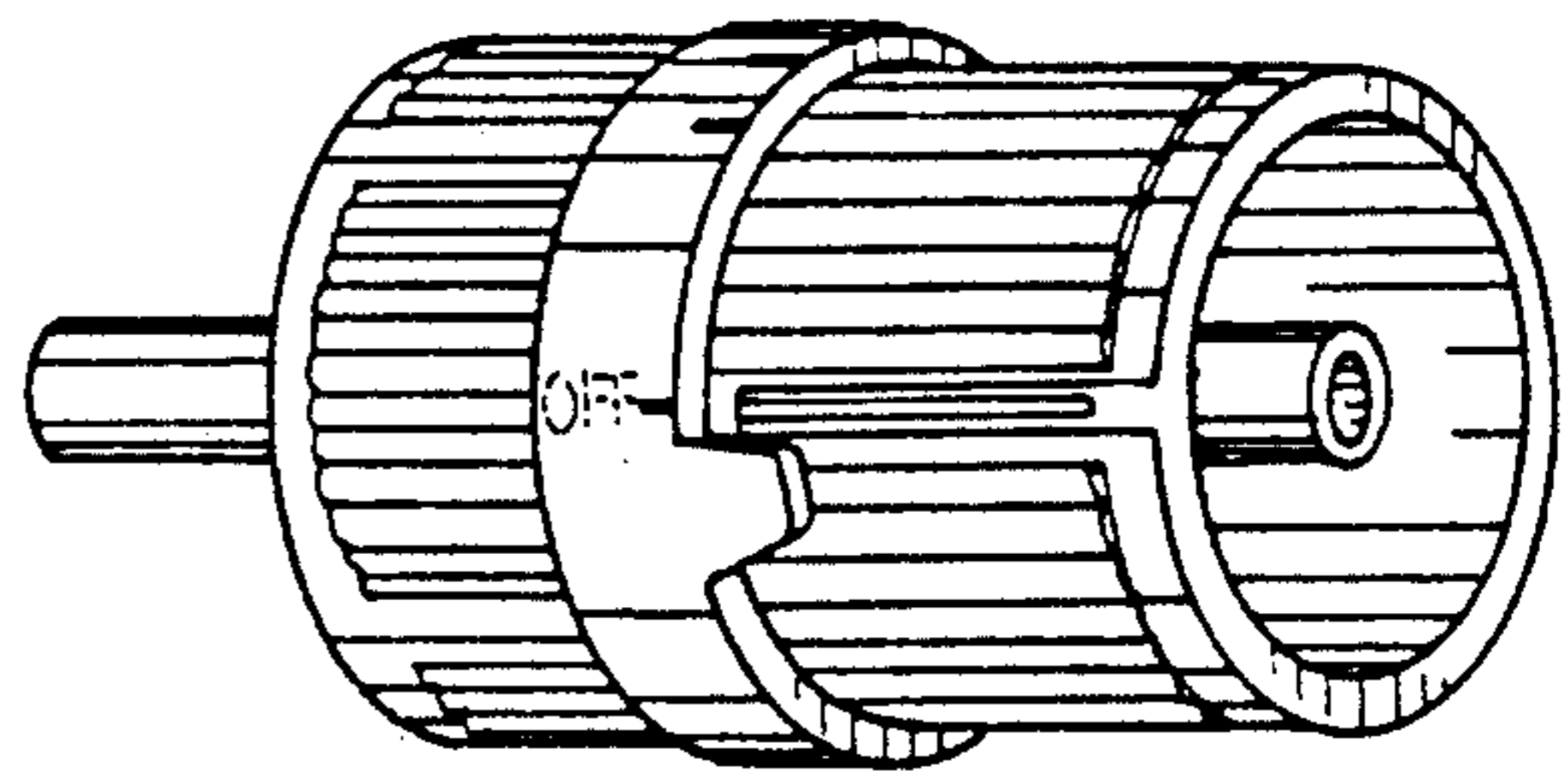

FIG. 4

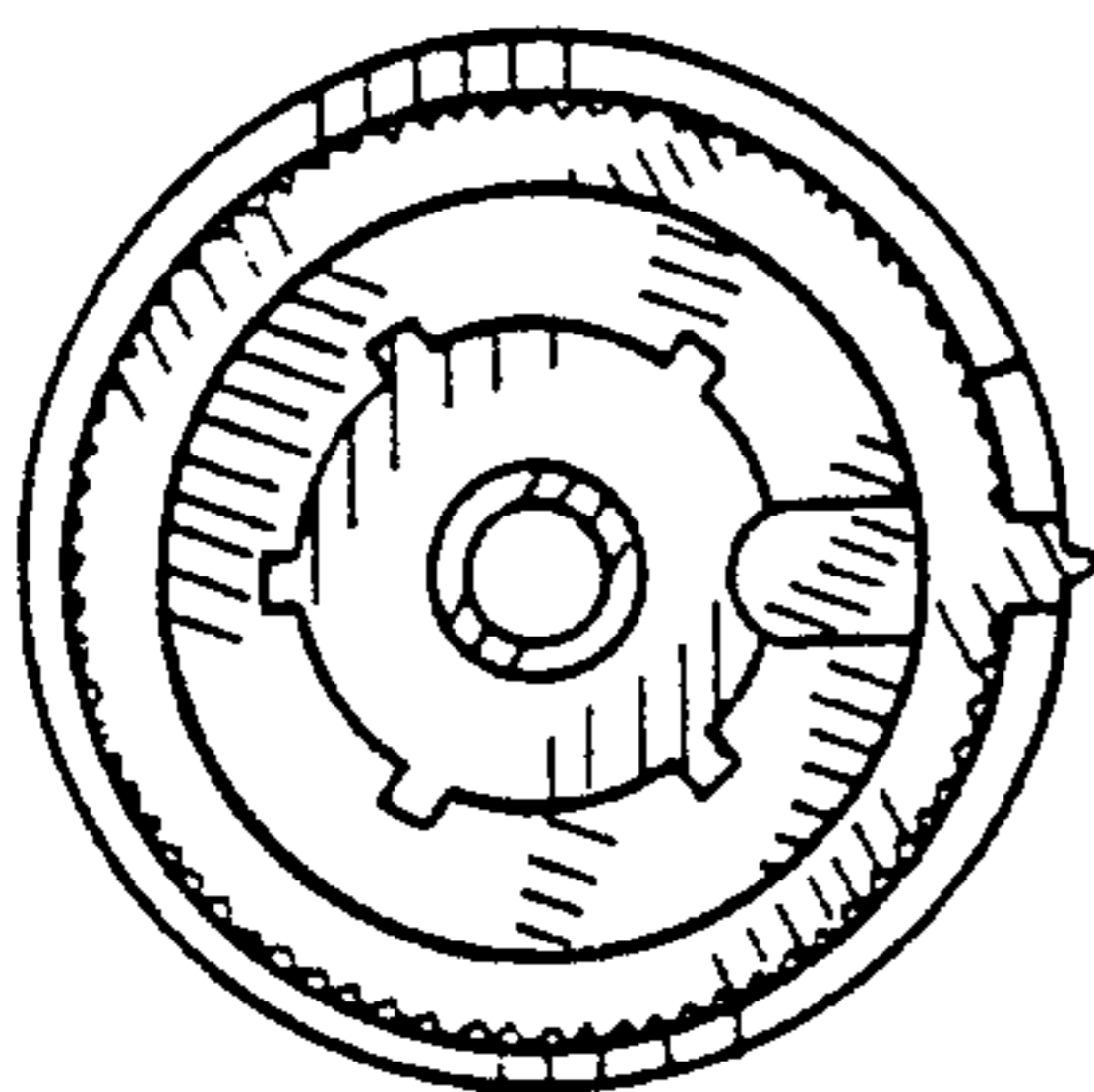
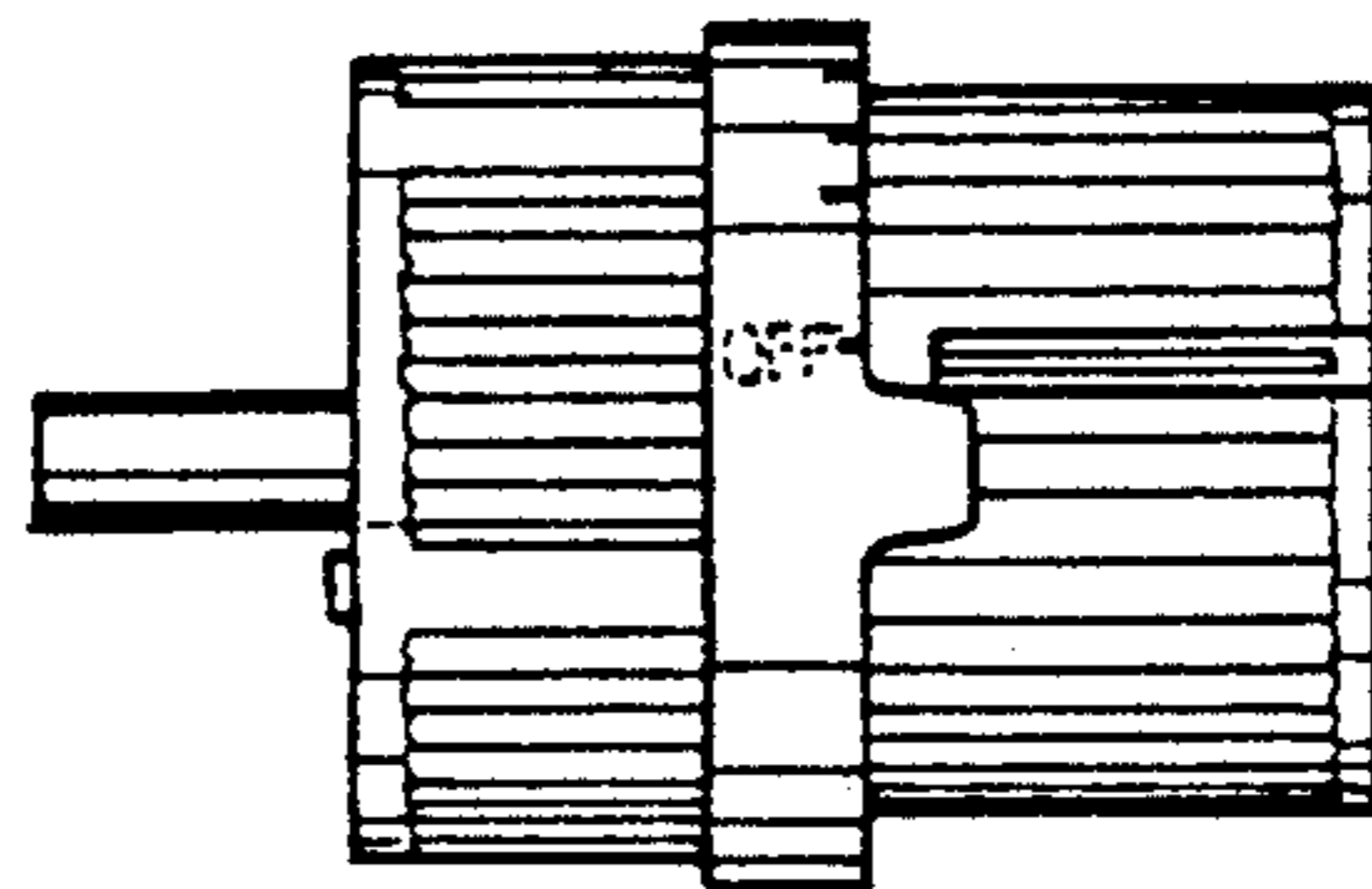

FIG. 5



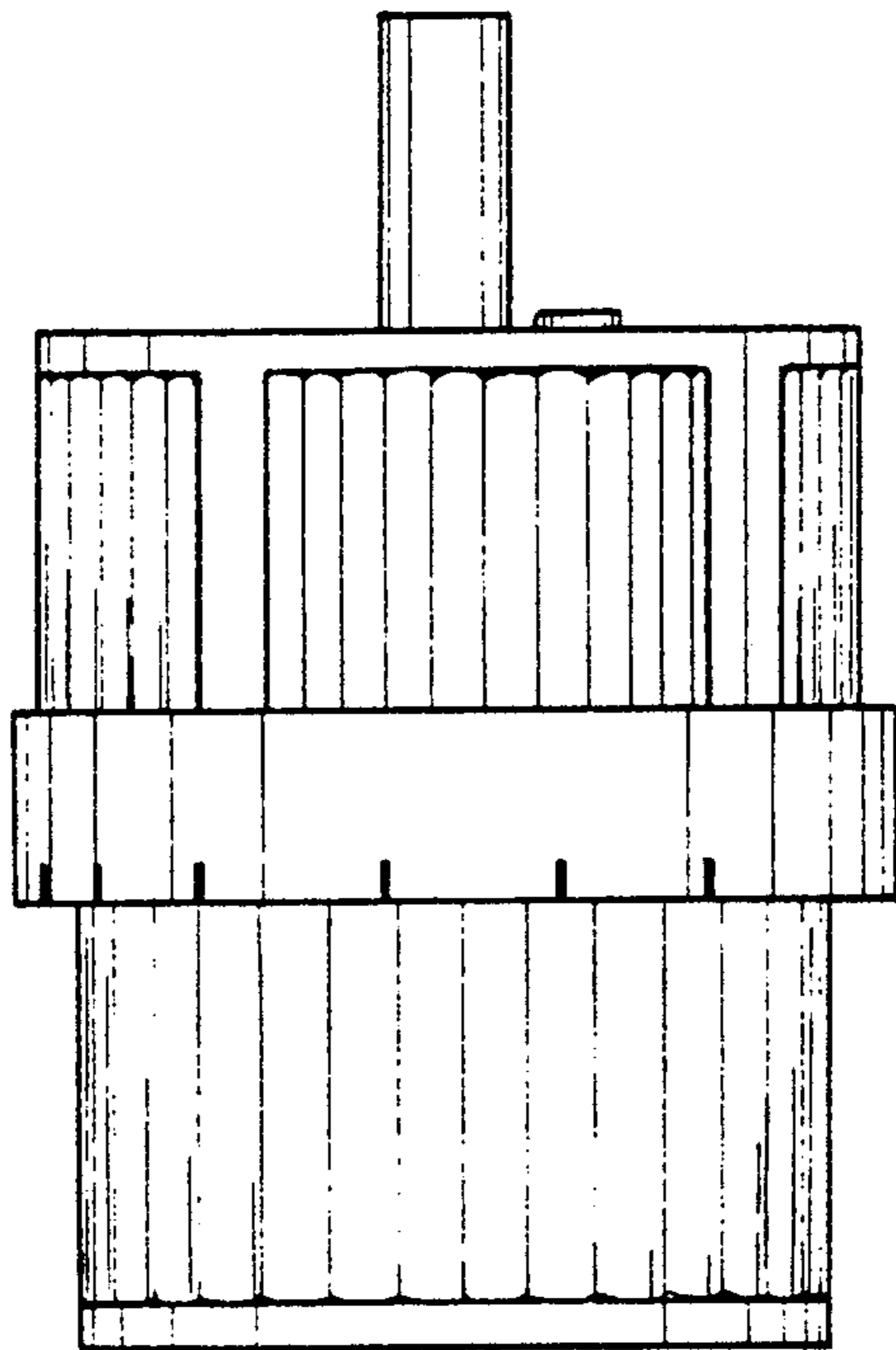

FIG. 6