

[54] CATAMARAN YACHT

[76] Inventor: Arthur C. Marks, Seagate Colony
Townhouse #6, 2830 Shore Dr.,
Virginia Beach, Va. 23451

[**] Term: 14 Years

[21] Appl. No.: 323,980

[22] Filed: Mar. 15, 1989

[52] U.S. Cl. D12/315; D12/304

[58] Field of Search D12/300, 304, 309, 310,
D12/315, 318; 114/60, 61, 292, 62, 271, 343,
355, 356, 357, 56, 292

3,345,967 10/1967 Sweet D12/312
3,611,967 10/1971 Bossler 114/61
3,885,693 5/1975 Haptonstall 214/516

Primary Examiner—Kay H. Chin
Attorney, Agent, or Firm—Shlesinger, Arkwright &
Garvey

[57] CLAIM

The ornamental design for a catamaran yacht, as shown and described.

DESCRIPTION

FIG. 1 is a left side elevational view of a catamaran yacht showing my new design, the right side elevational view being a mirror image of that shown;
FIG. 2 is a top plan view thereof;
FIG. 3 is a bottom plan view thereof;
FIG. 4 is a front elevational view thereof;
FIG. 5 is a rear elevational view thereof; and
FIG. 6 is a front perspective view thereof.

[56] References Cited

U.S. PATENT DOCUMENTS

D. 217,512 5/1970 Schwartz D12/315
D. 226,402 2/1973 Krutz D12/315
2,348,783 5/1944 Brunt 114/66.5

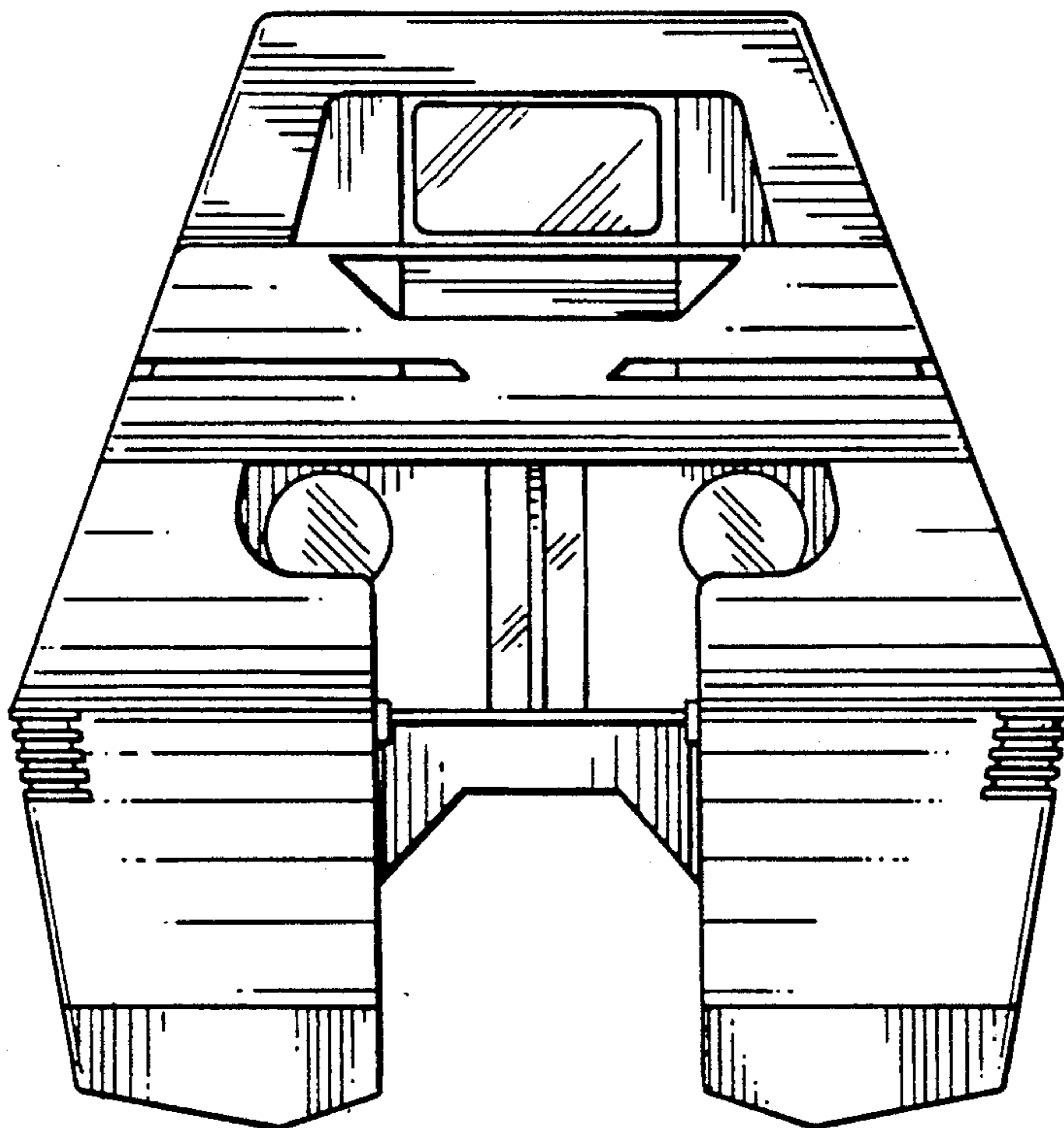

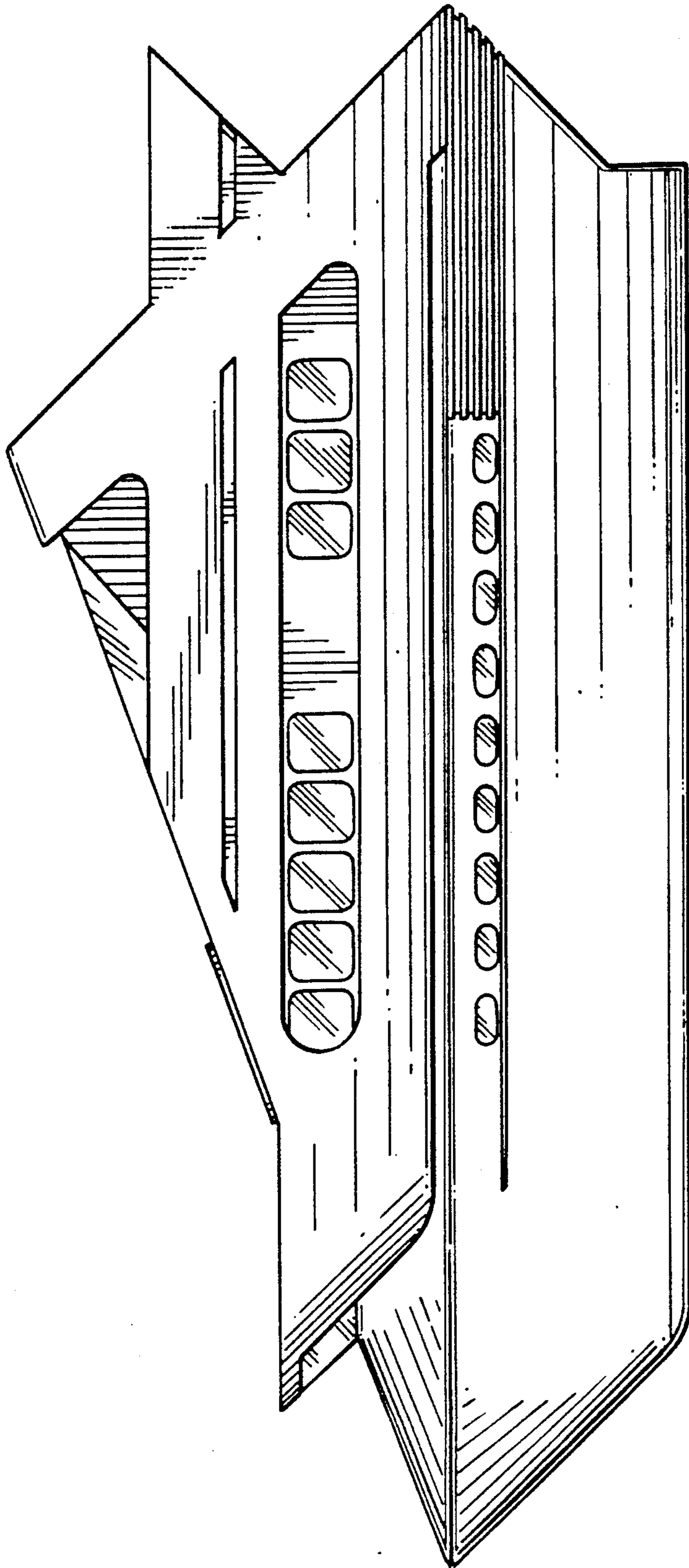

FIG. 1

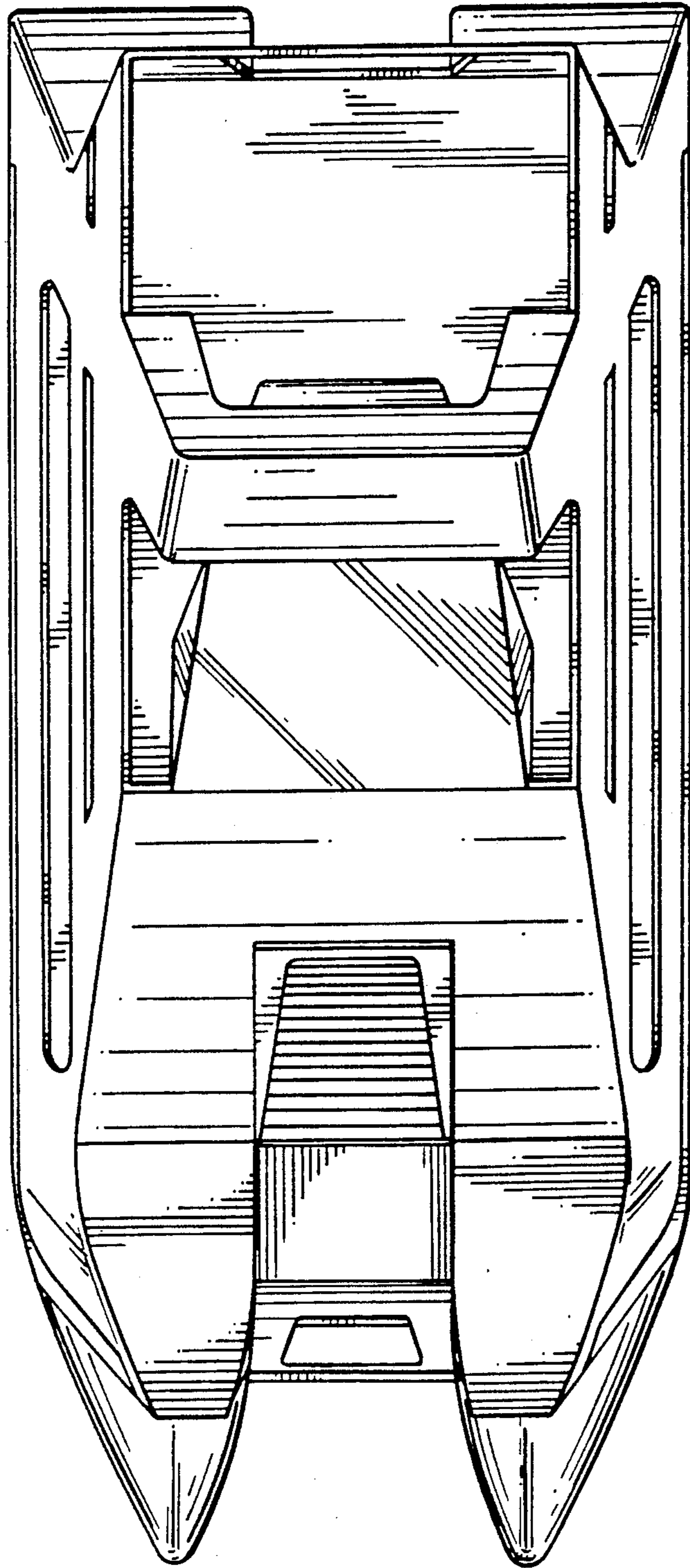

FIG. 2

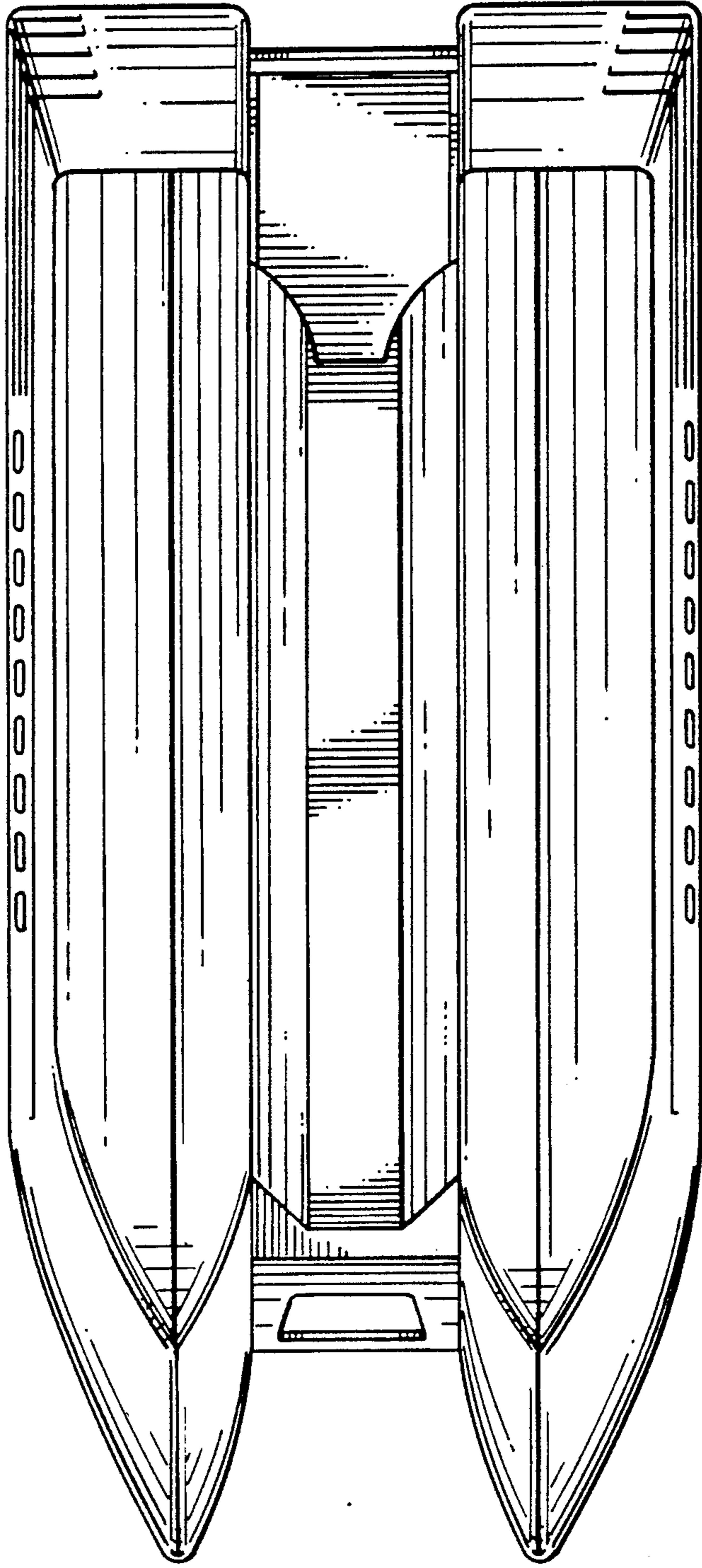

FIG. 3

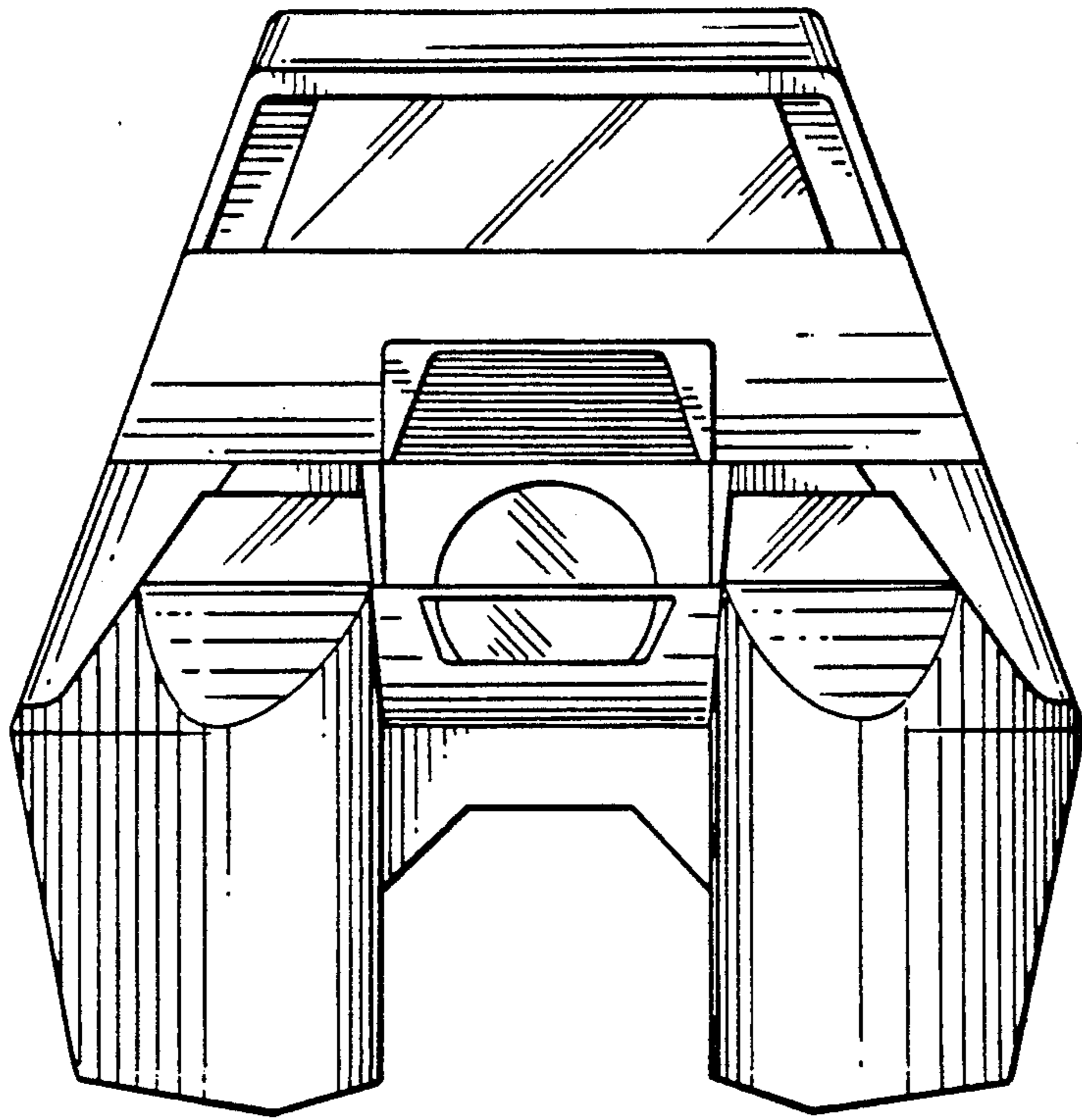

FIG. 4

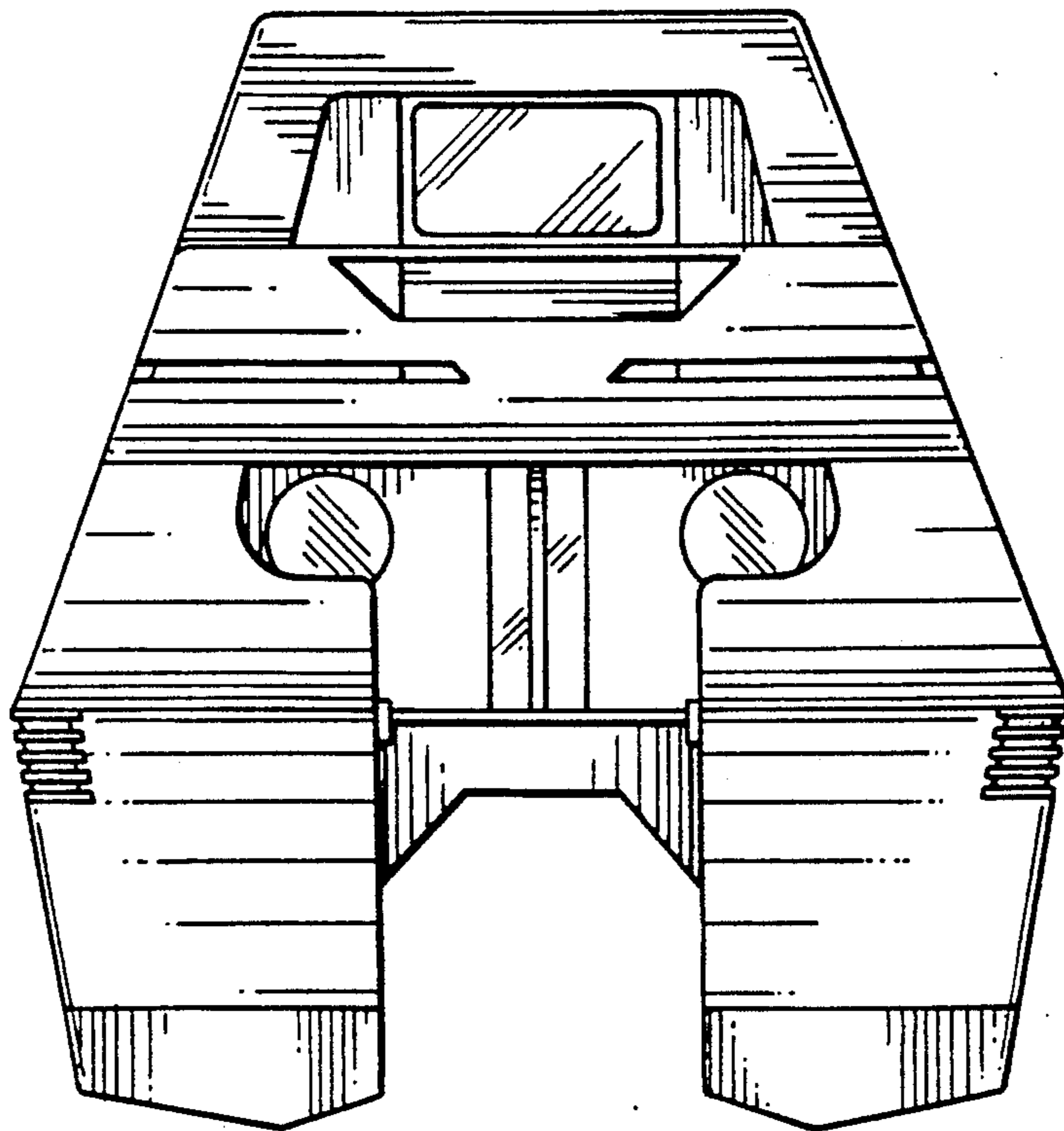

FIG. 5

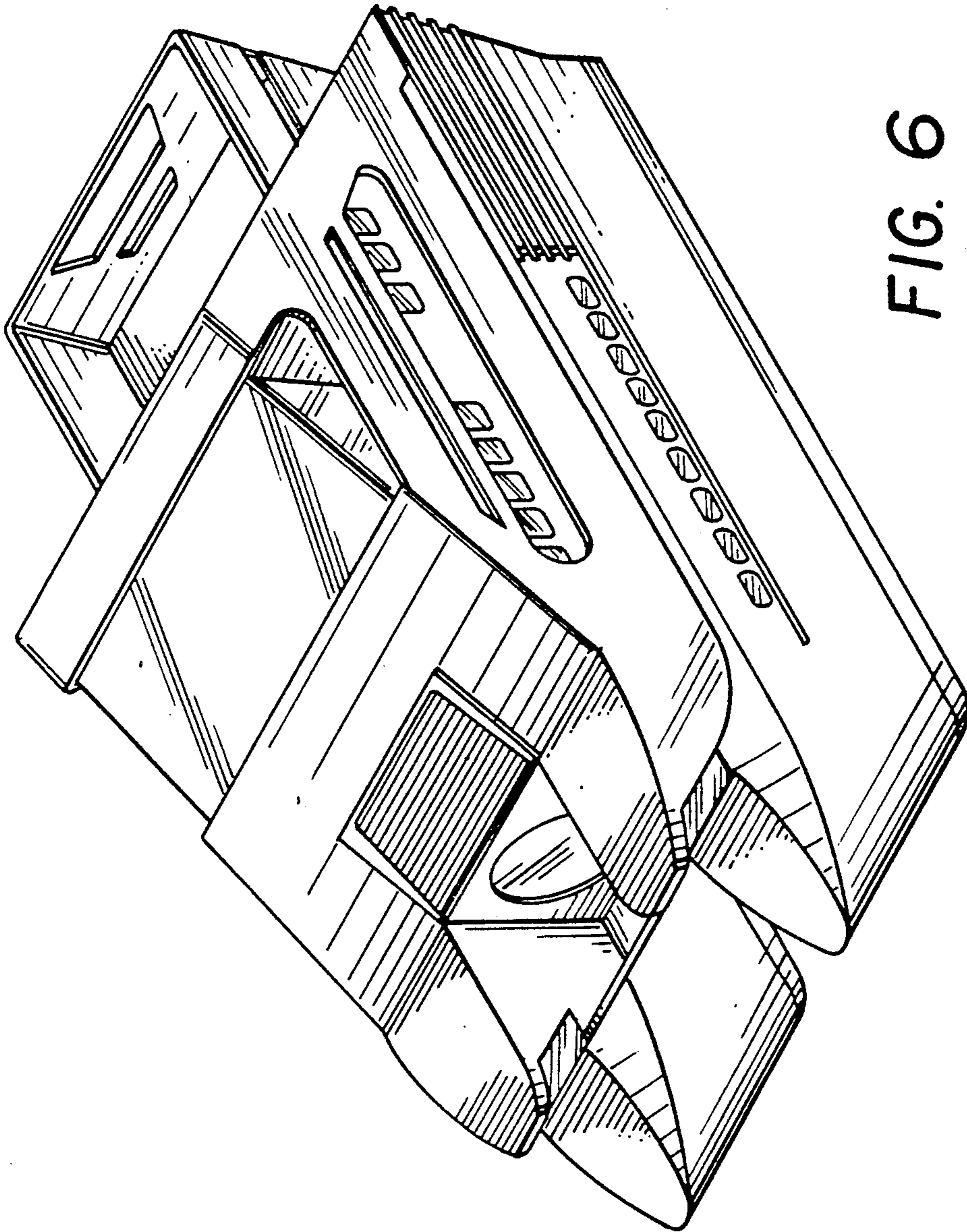

FIG. 6