

[54] CLOCK FACE

[76] Inventor: Mike D. Baum, 8 Crown St., Rockville, Conn. 06066

[**] Term: 14 Years

[21] Appl. No.: 246,524

[22] Filed: Sep. 19, 1988

[52] U.S. Cl. D10/125; D10/6; D10/126

[58] Field of Search D10/1-40, D10/122-132; D21/27, 11; 368/223, 228, 232, 238, 285

[56] References Cited

U.S. PATENT DOCUMENTS

- D. 247,481 3/1978 Bernyk D10/6 X
- D. 262,722 1/1982 Tsuyuki D21/27 X
- D. 285,579 9/1986 Hill D21/27 X

Primary Examiner—Nelson C. Holtje
Attorney, Agent, or Firm—McCormick, Paulding & Huber

[57] CLAIM

The ornamental design for a clock face, as shown and described.

DESCRIPTION

FIG. 1 is a front and bottom-left perspective view of a clock face showing my new design;
 FIG. 2 is a front elevational view thereof;
 FIG. 3 is a bottom plan view thereof, the top plan view being a mirror image;
 FIG. 4 is right side elevational view, the left side being a mirror image;
 FIG. 5 is a rear elevational view thereof, the dial plate having been omitted for ease of illustration; and
 FIG. 6 is a cross-sectional view as taken from line 6—6 of FIG. 2.

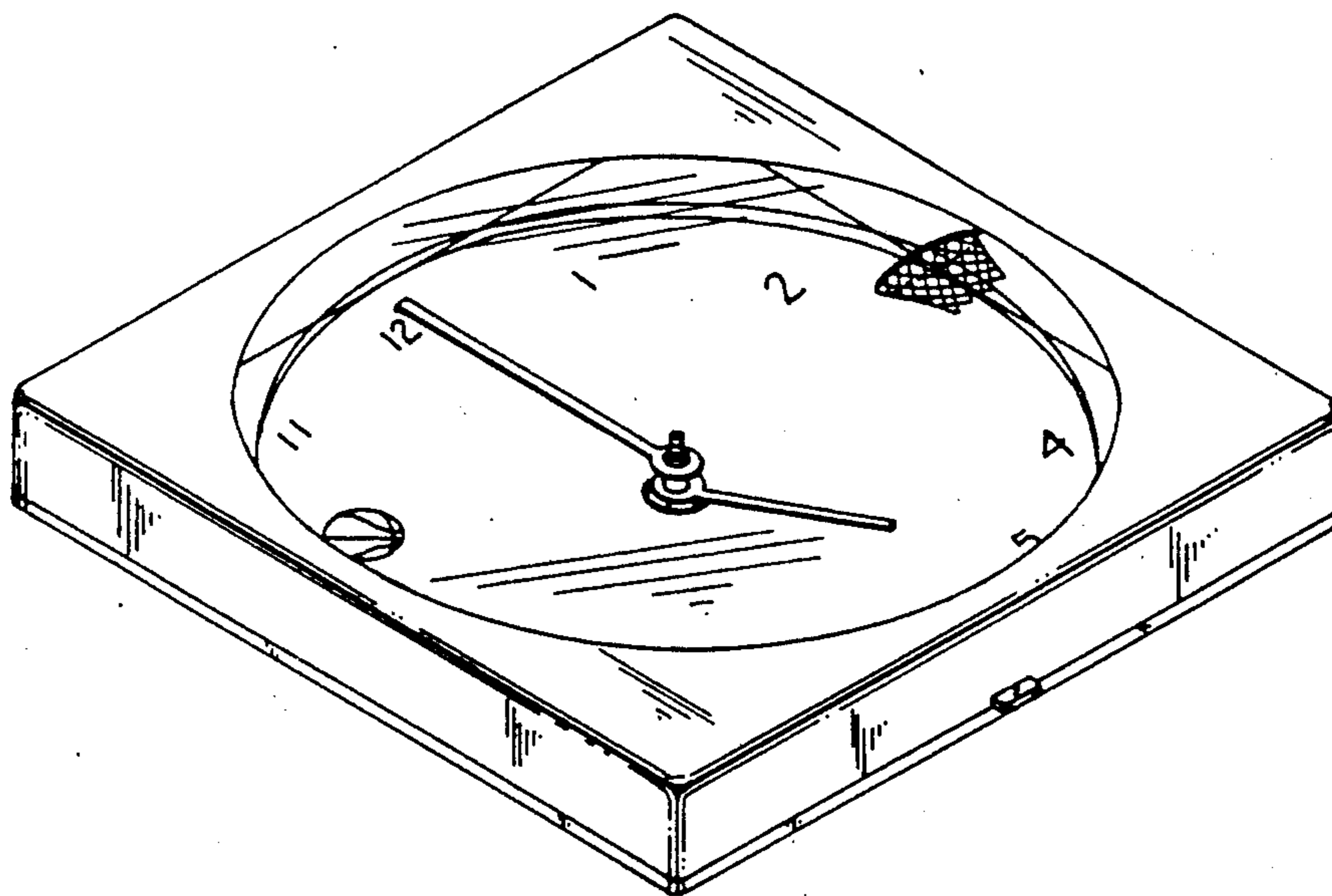

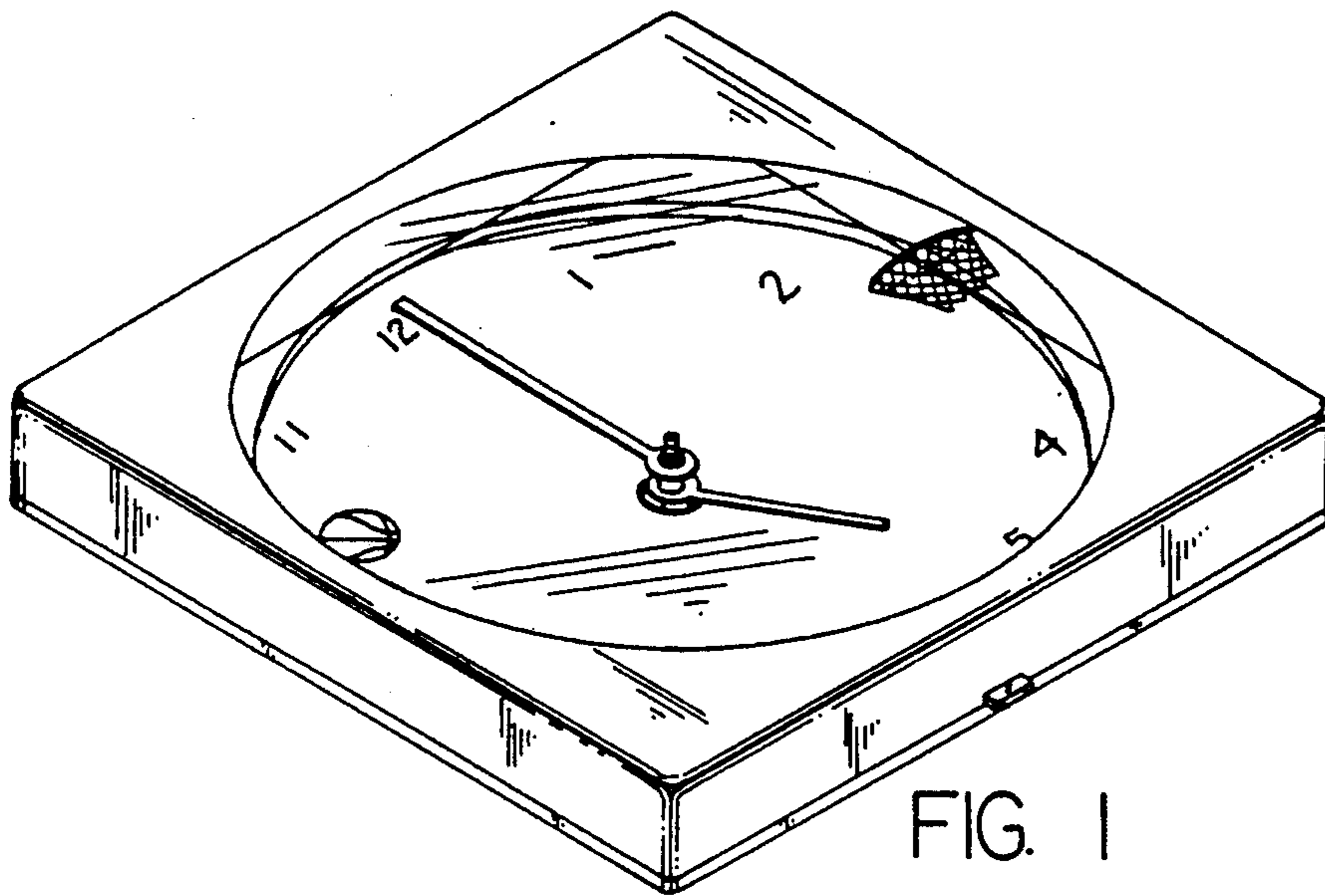

FIG. 1

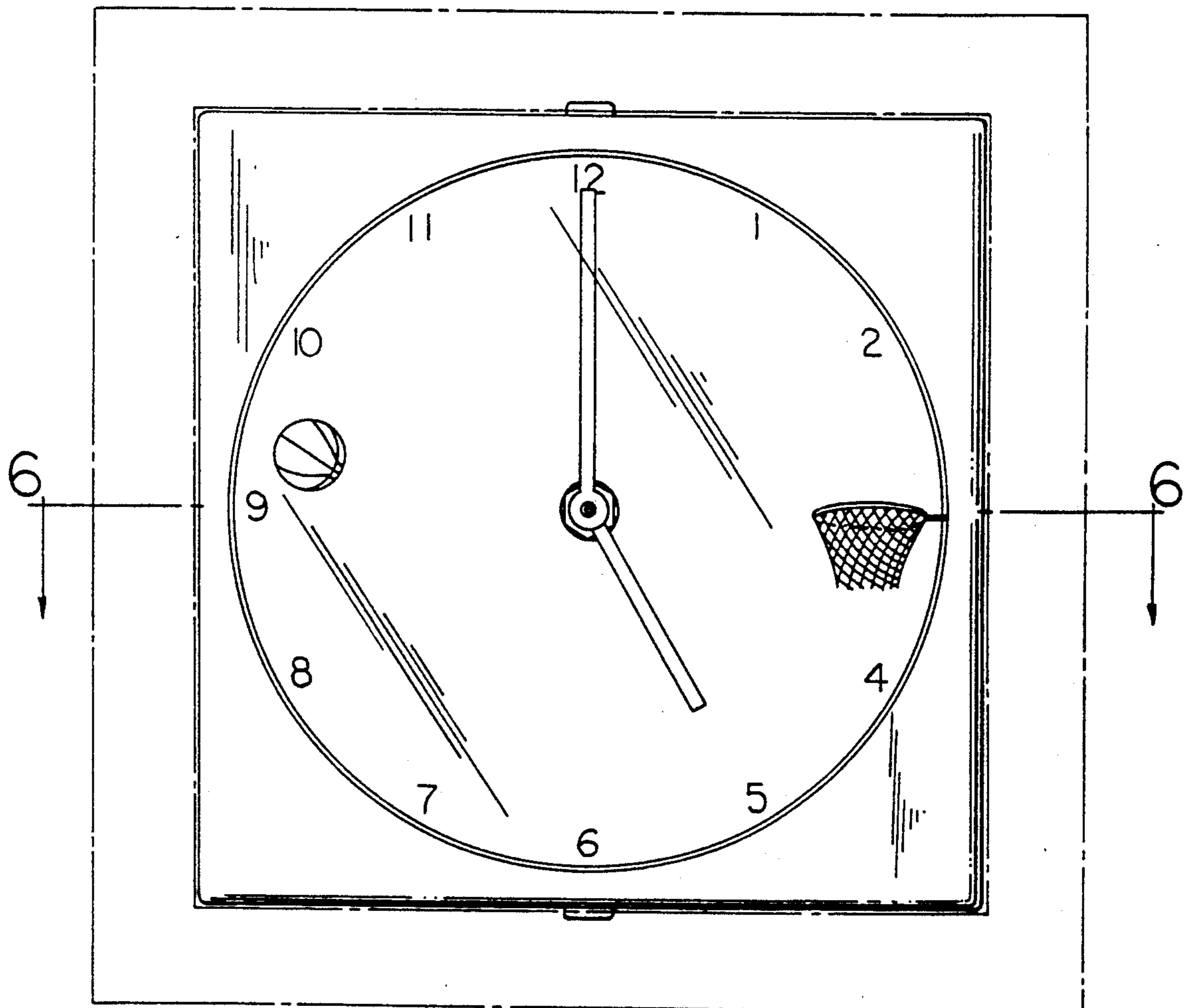

FIG. 2

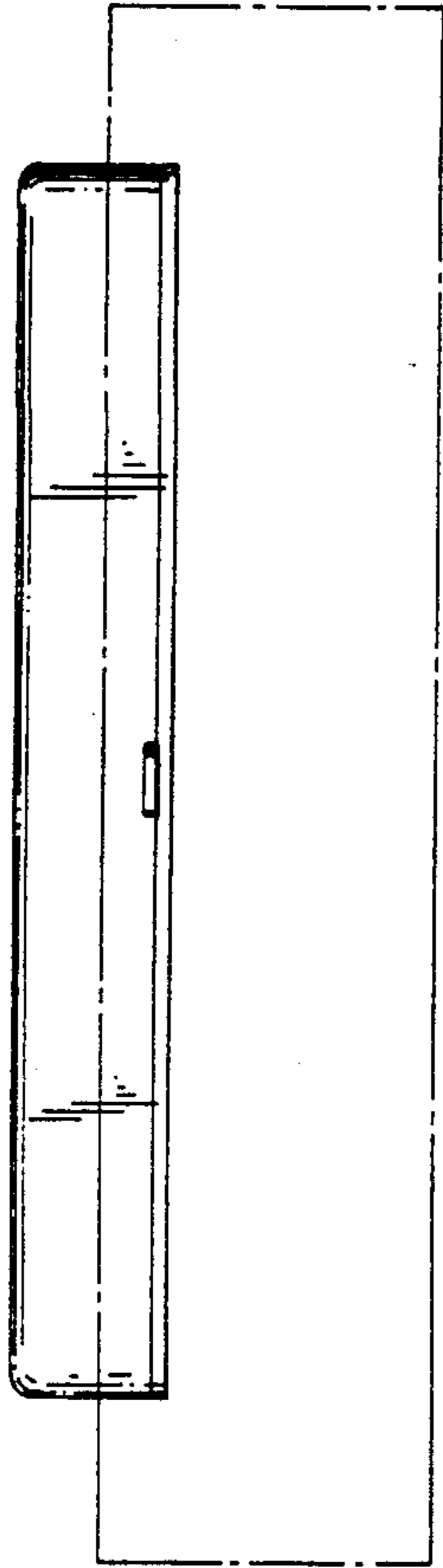

FIG. 3

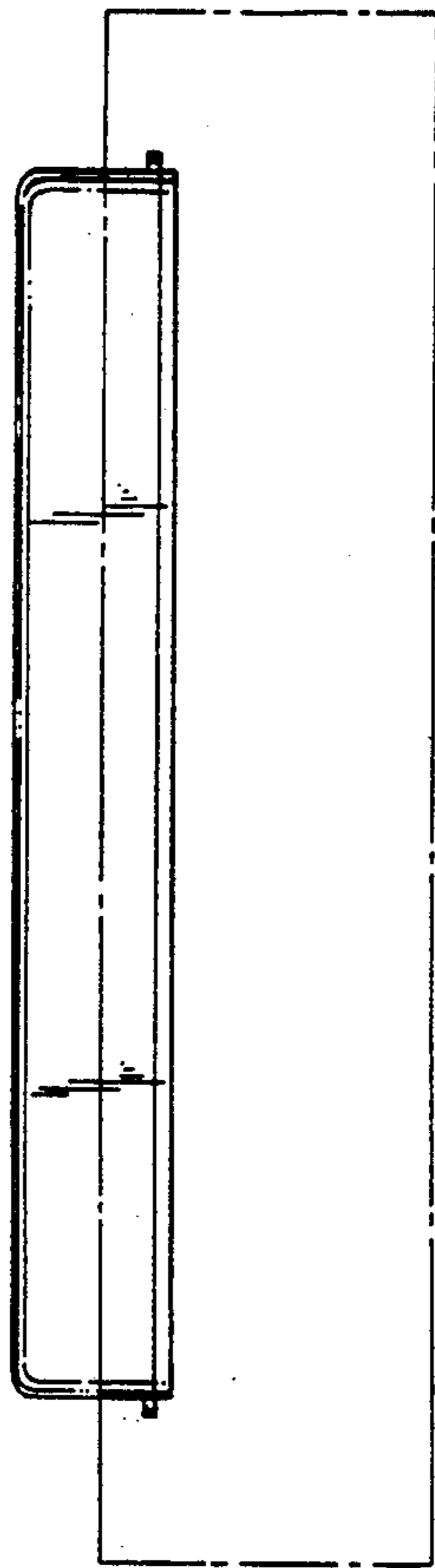

FIG. 4

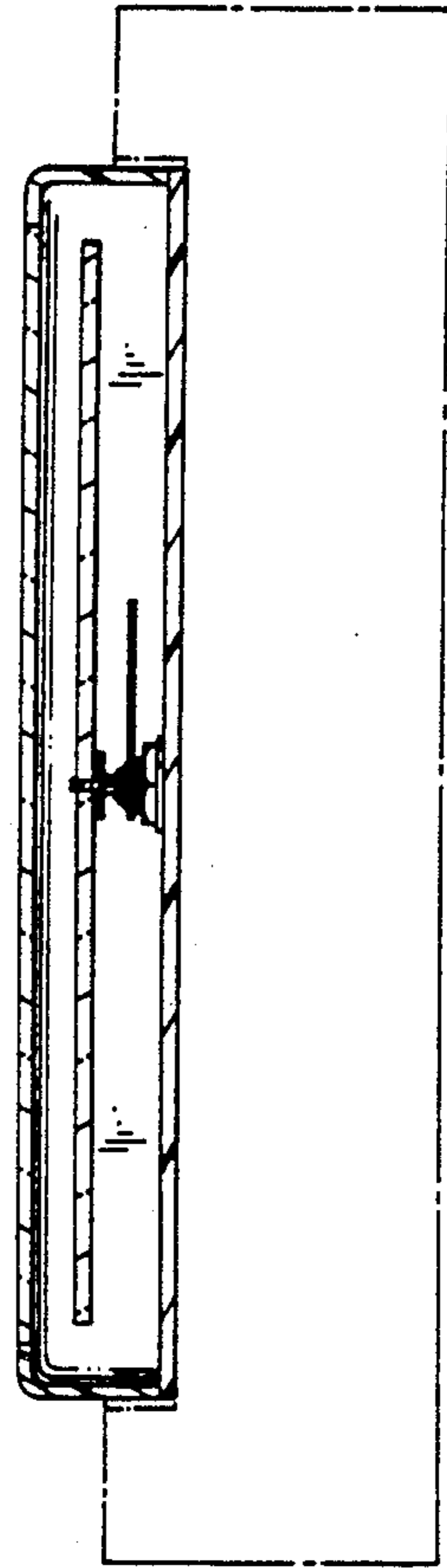

FIG. 6

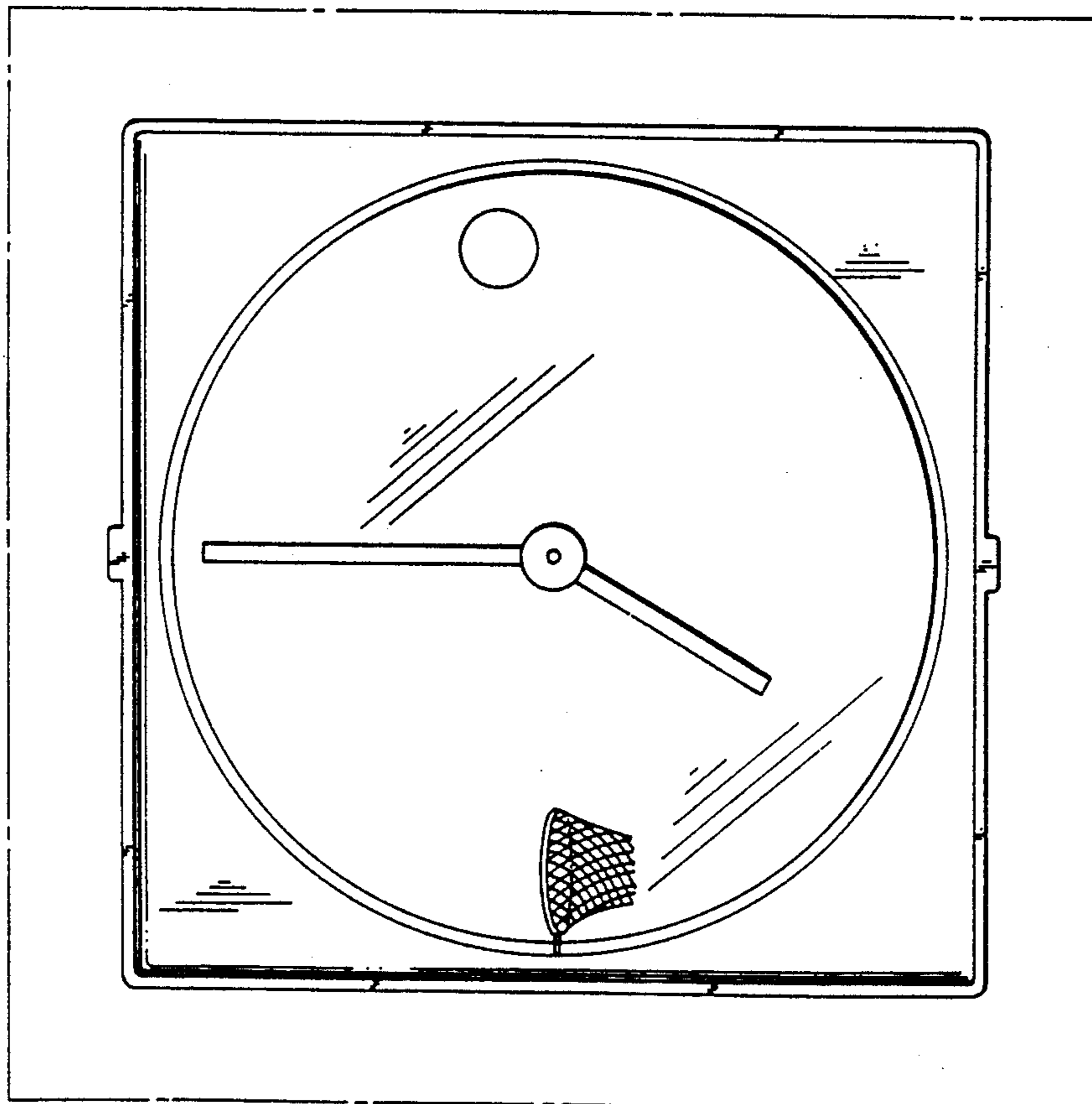

FIG. 5

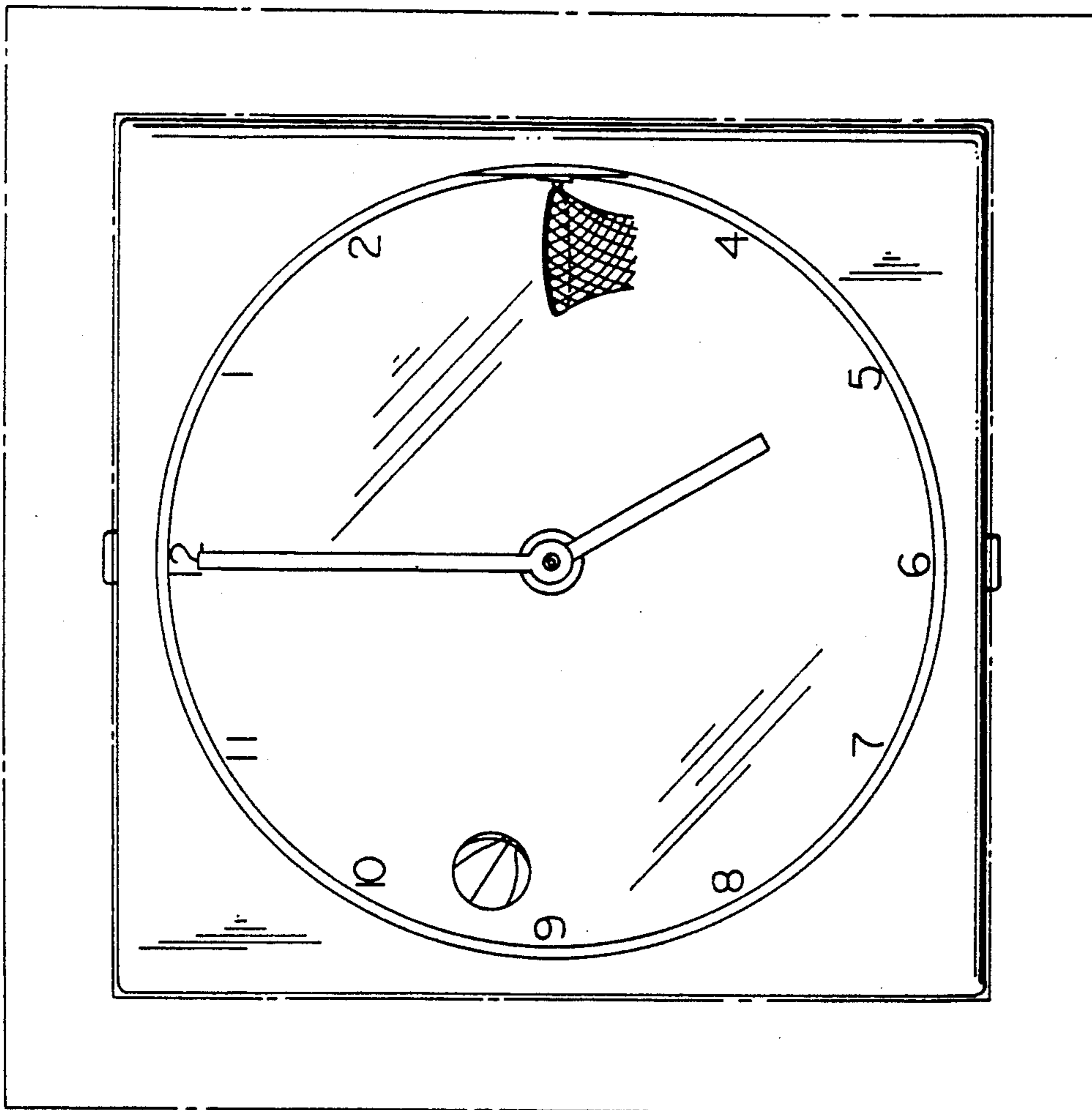

FIG. 7