

[54] HEADPHONE

[75] Inventors: Takefumi Daido, Tokyo; Akira Yamazaki, Niiza; Katsumi Yamatogi, Tokyo, all of Japan

[73] Assignee: Sony Corporation, Tokyo, Japan

[\*\*] Term: 14 Years

[21] Appl. No.: 337,547

[22] Filed: Apr. 14, 1989

[52] U.S. Cl. .... D14/205

[58] Field of Search ..... D14/204, 205, 206, 223; 381/25, 68, 91, 122, 156, 158, 183, 187; 379/430, 444; 181/129, 133

[56] References Cited

U.S. PATENT DOCUMENTS

- D. 297,324 8/1988 Kohno ..... D14/205
- D. 305,541 1/1990 Hirose ..... D14/205
- D. 310,081 8/1990 Daido et al. .... D14/205

OTHER PUBLICATIONS

Stereo Review; Dec. 1987; p. 77; top center—Nakamichi Model SP-7 Headphones.

Crutchfield Cat.—Summer 1986; p. 89; top right—Model MDR-M77.

Primary Examiner—Theodore M. Shooman  
Attorney, Agent, or Firm—Lewis H. Eslinger

[57] CLAIM

The ornamental design for a headphone, as shown and described.

DESCRIPTION

FIG. 1 is a top, front, and right-side perspective view of a headphone, showing our new design;  
 FIG. 2 is a front elevational view thereof;  
 FIG. 3 is a rear elevational view thereof;  
 FIG. 4 is a left-side elevational view thereof, the right-side being a mirror image thereof;  
 FIG. 5 is a top plan view thereof; and  
 FIG. 6 is a bottom plan view thereof.

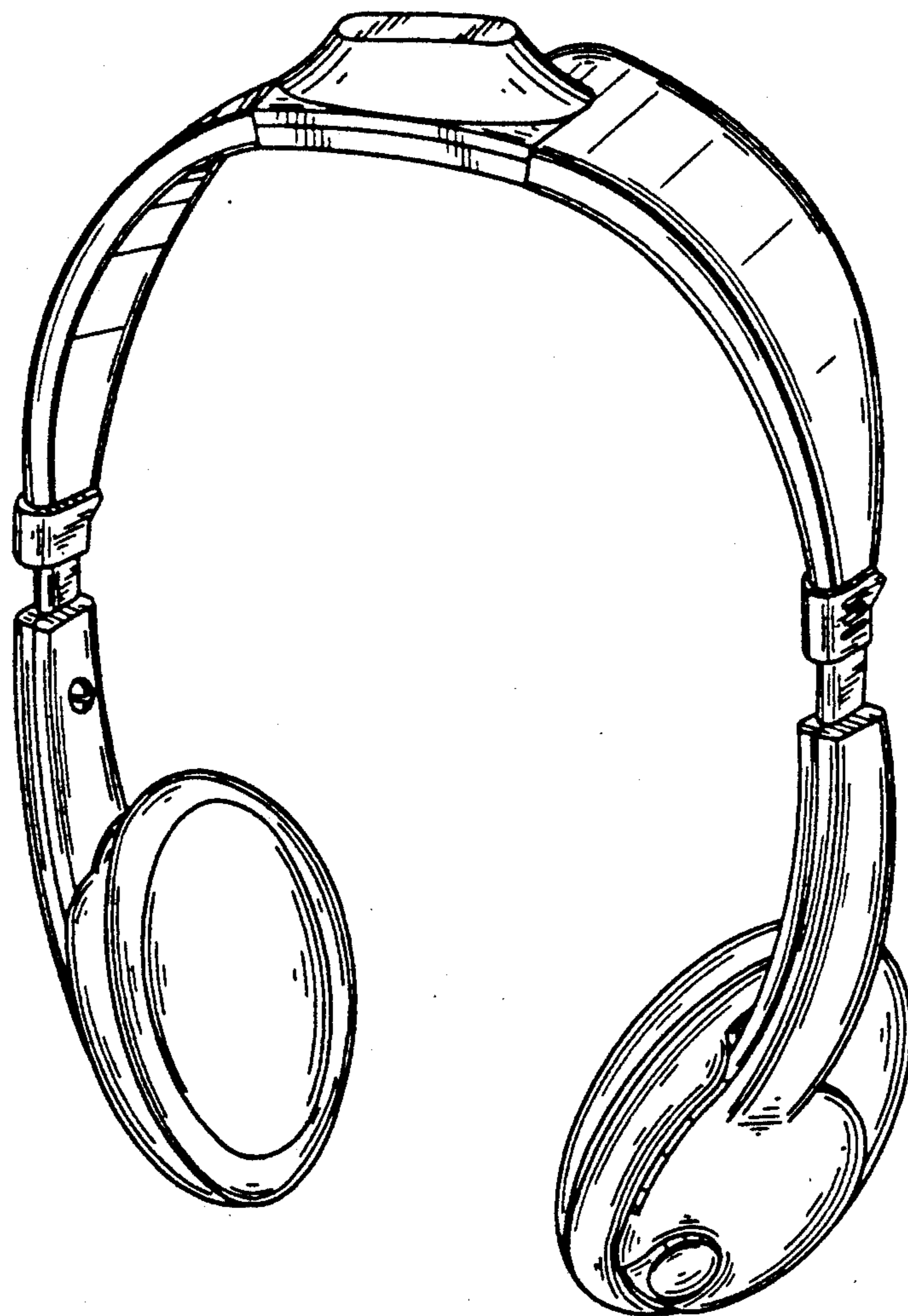

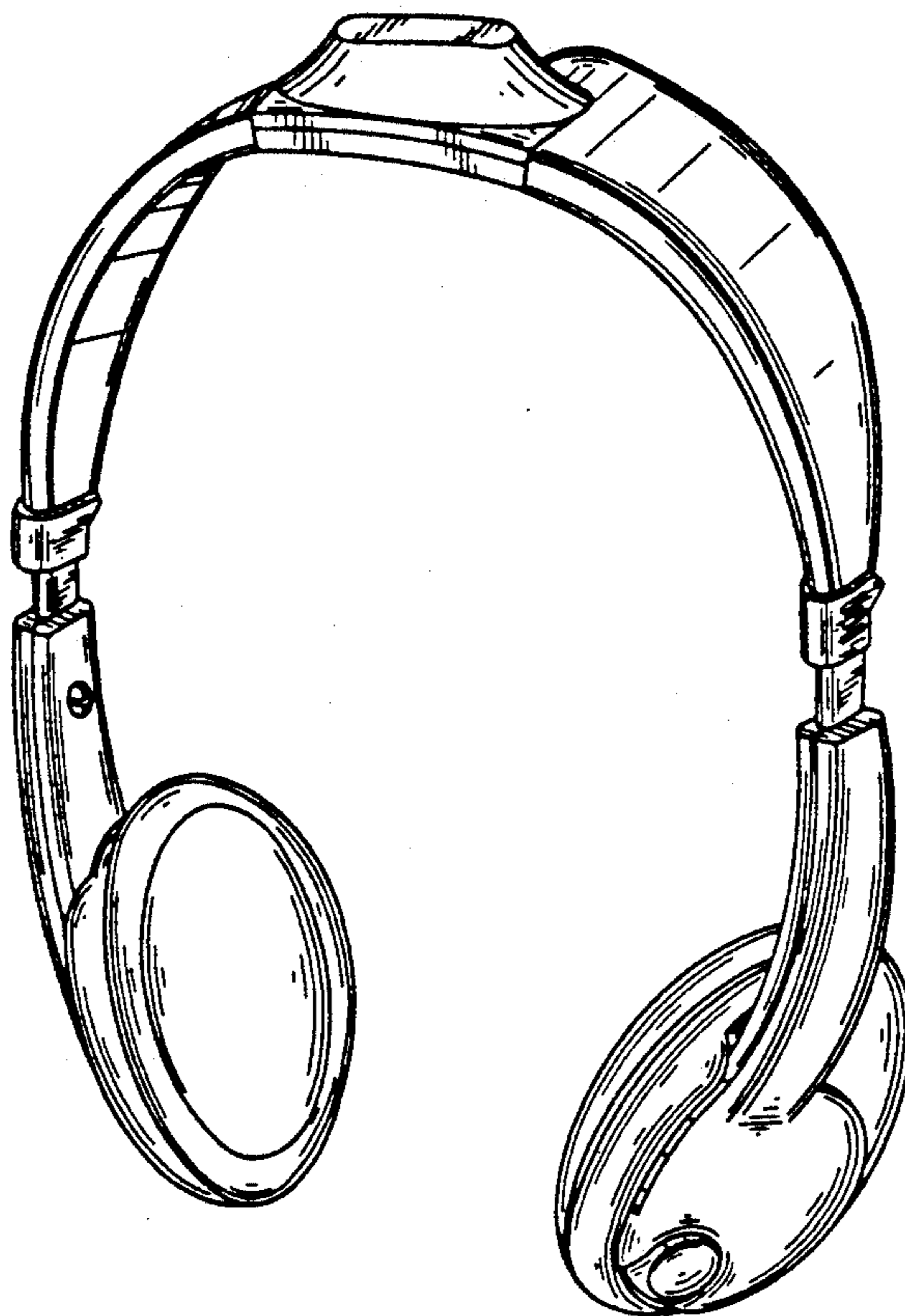

FIG. 1

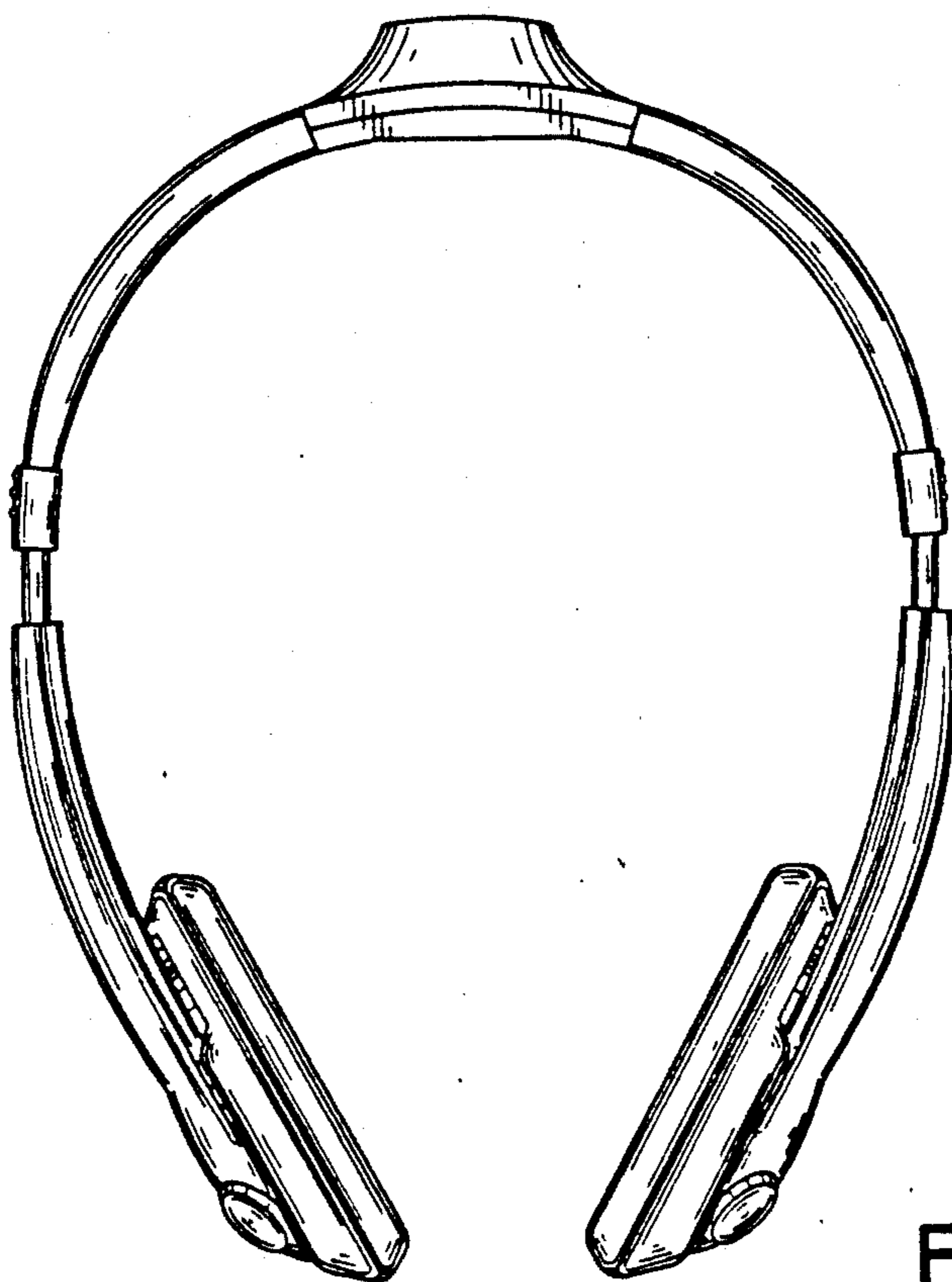

FIG. 2

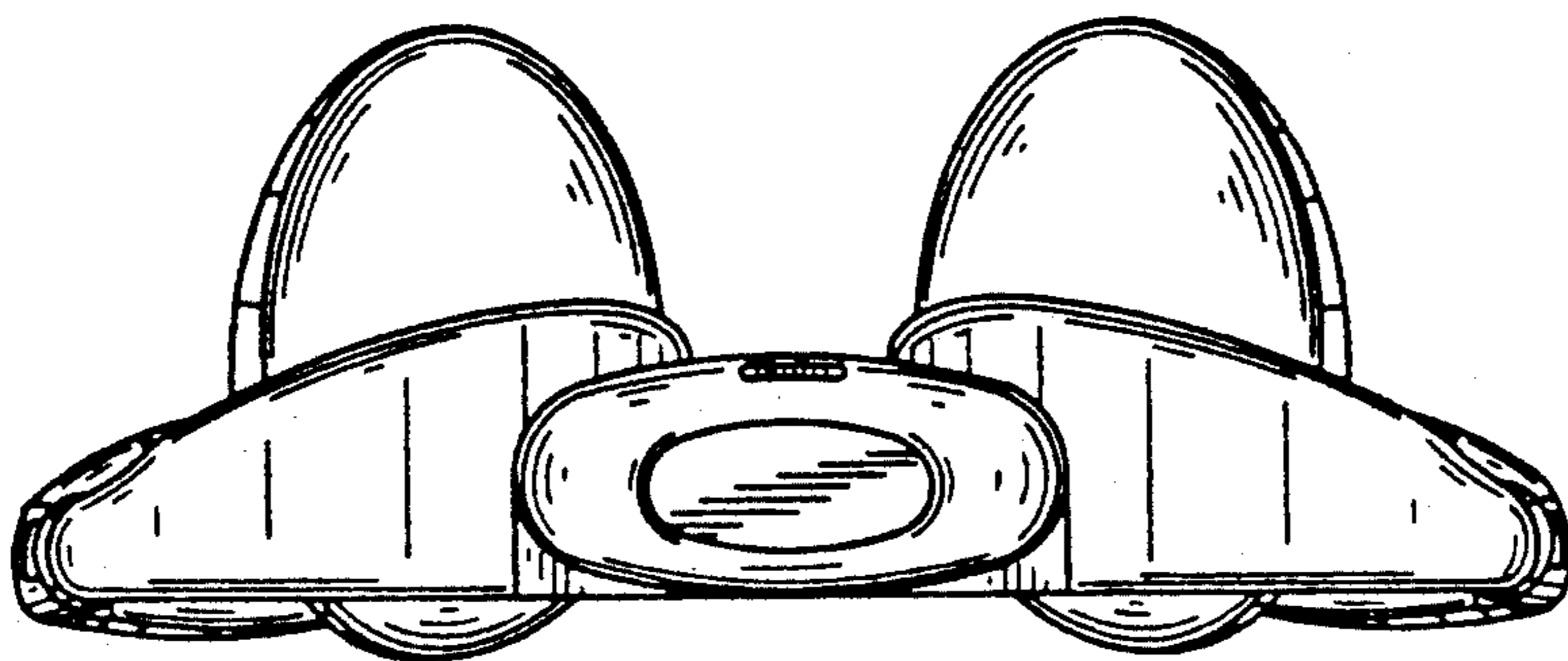

FIG. 5

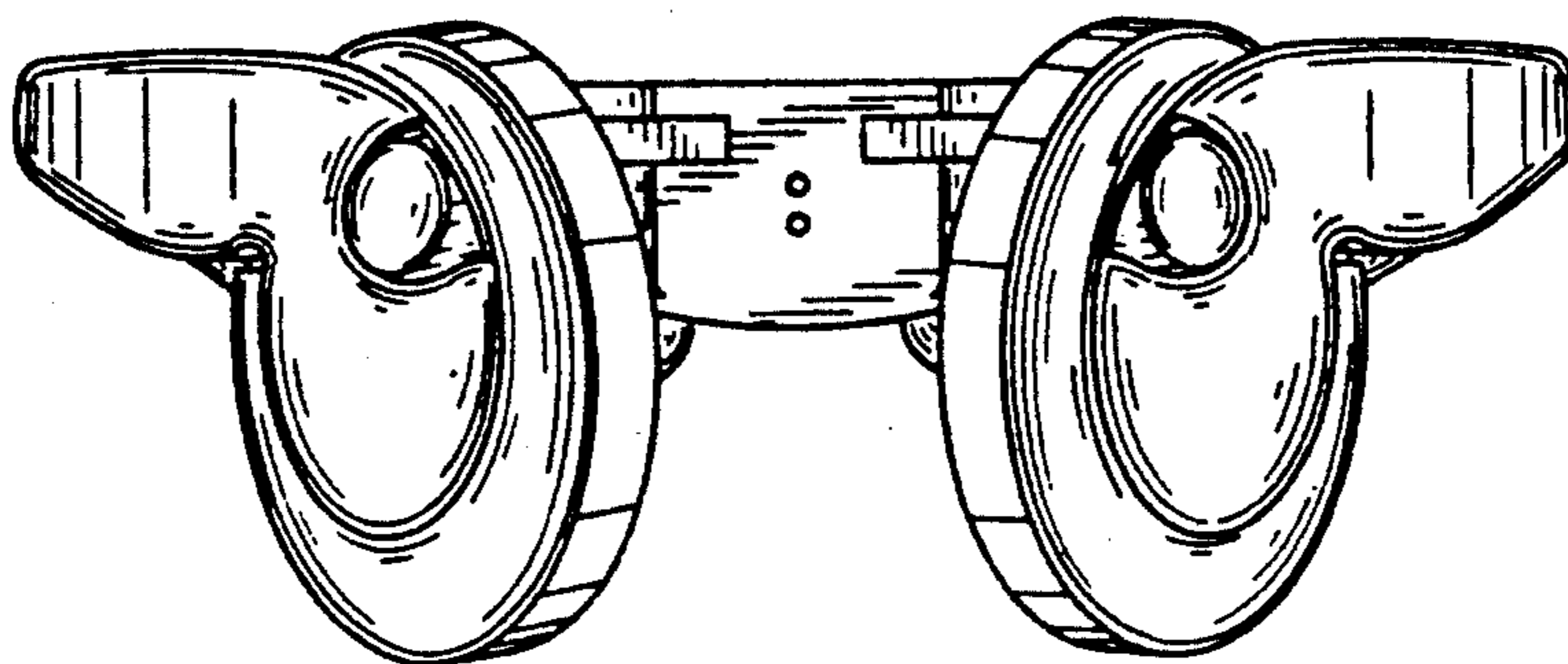

FIG. 6

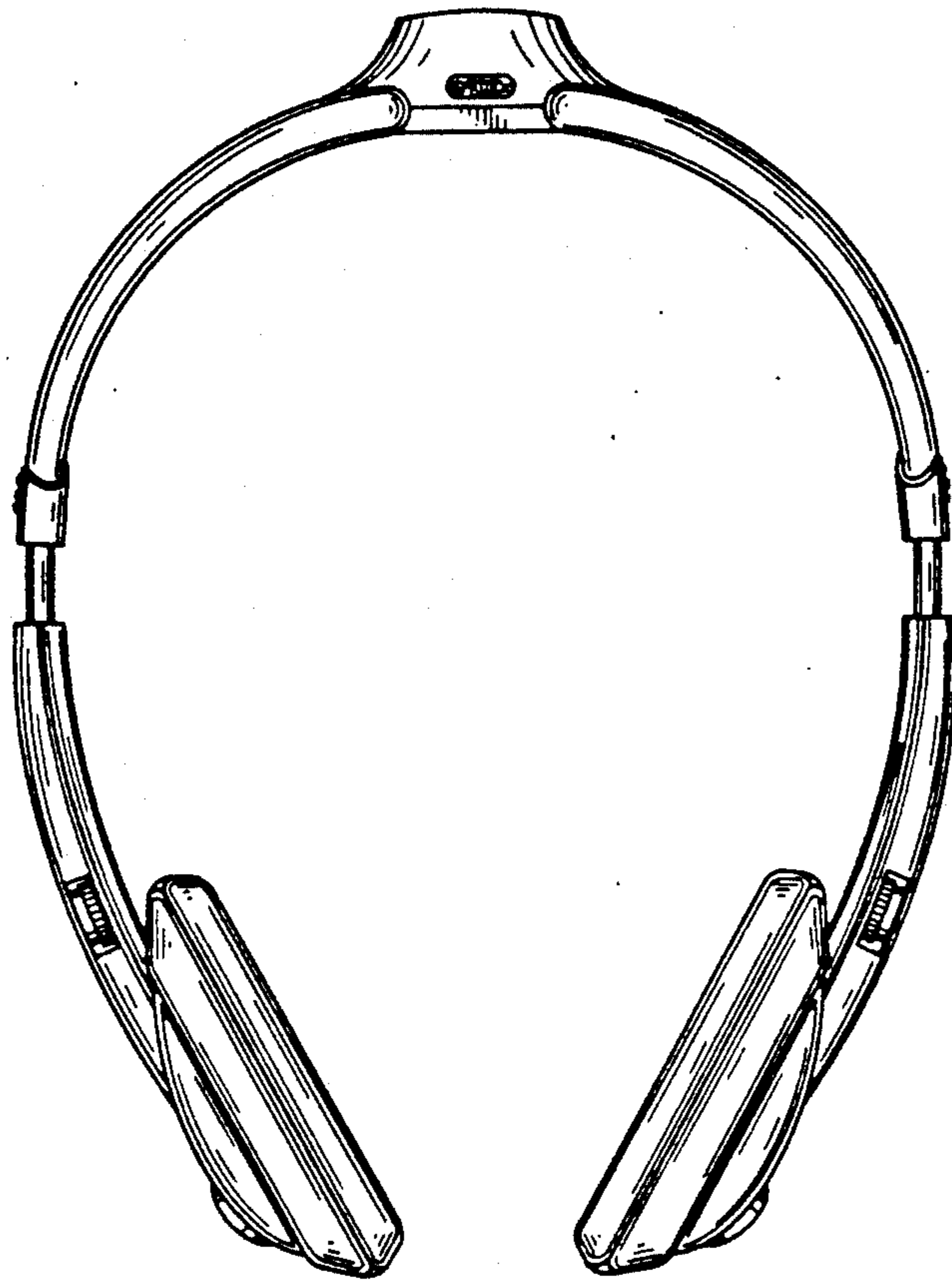

FIG. 3

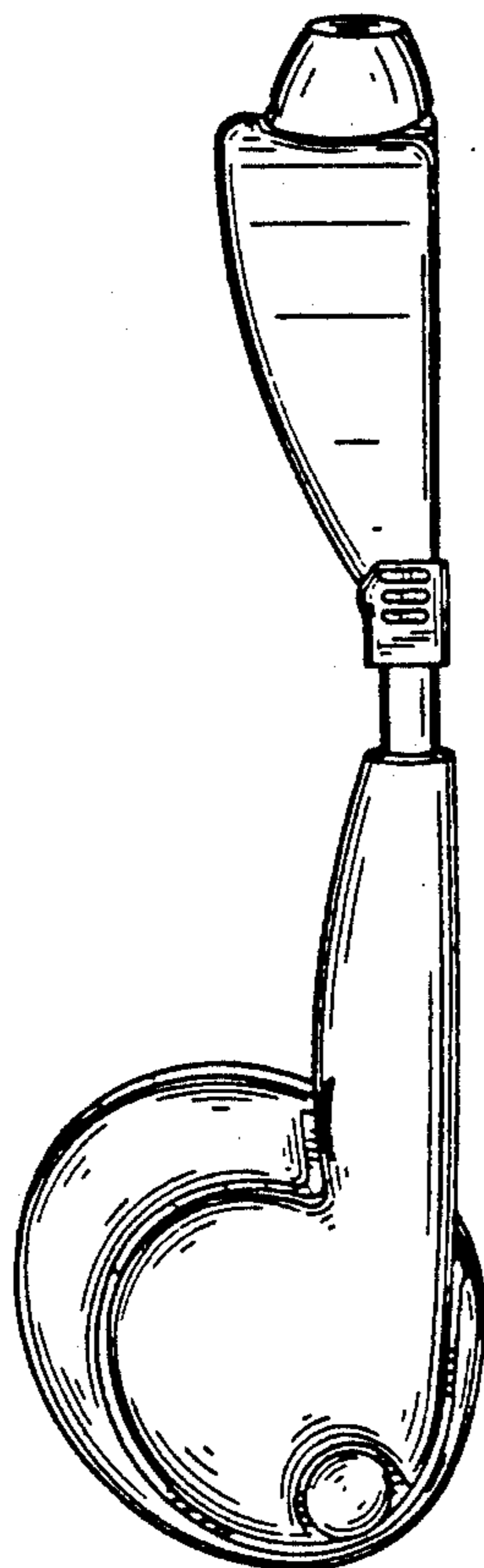

FIG. 4