

[54] BARCODE READER

[75] Inventors: Seiichi Mori; Toshimasa Yamanaka; Takeshi Matsushita, all of Tokyo, Japan

[73] Assignee: Asahi Kogaku Kogyo K.K., Tokyo, Japan

[**] Term: 14 Years

[21] Appl. No.: 466,827

[22] Filed: Jan. 16, 1990

[30] Foreign Application Priority Data

Jul. 19, 1989 [JP] Japan 1-26729
Oct. 5, 1989 [JP] Japan 1-36415

[52] U.S. Cl. D14/116

[58] Field of Search D14/100, 105, 107, 114, D14/116; D8/99; 235/380, 441, 454, 455, 463, 462, 479, 381, 470-475, 482, 487; 250/203.1, 239, 566, 568, 569; 358/407, 408, 473, 474, 479; 354/80-82; 355/231, 233; 382/58, 59, 62, 63, 65

[56] References Cited

U.S. PATENT DOCUMENTS

D. 240,606 7/1976 Koenig D14/116
4,335,303 6/1982 Call 235/463
4,736,096 4/1988 Ushikubo 235/381 X
4,743,773 5/1988 Katana et al. 235/472 X
4,970,379 11/1990 Danstrom 235/455 X

OTHER PUBLICATIONS

Tescom Catalog Sheet Of Model No. TE-610RN, exact

issue date unknown but issued at least before Jul. 19, 1989.

Tescom Catalog Sheet of Model OEM Pen Scanner OE-10, Exact Issue Date Unknown But Issued At Least Before Jul. 19, 1989.

Primary Examiner—Susan J. Lucas
Assistant Examiner—Freda S. Nunn
Attorney, Agent, or Firm—Sughrue, Mion, Zinn Macpeak & Seas

[57] CLAIM

The ornamental design for a barcode reader, as shown and described.

DESCRIPTION

FIG. 1 is a top, front, right side perspective view of a barcode reader showing our new design; FIG. 2 is a right side elevational view thereof; FIG. 3 is a top plan view thereof; FIG. 4 is a front elevational view thereof; FIG. 5 is a rear elevational view thereof; FIG. 6 is a left side elevational view thereof; FIG. 7 is a bottom plan view thereof; FIG. 8 is a top, front, right side perspective view of a second embodiment of our new design; FIG. 9 is a right side elevational view thereof; FIG. 10 is a top plan view thereof; FIG. 11 is a front elevational view thereof; FIG. 12 is a rear elevational view thereof; FIG. 13 is a left side elevational view thereof; and FIG. 14 is a bottom plan view thereof.

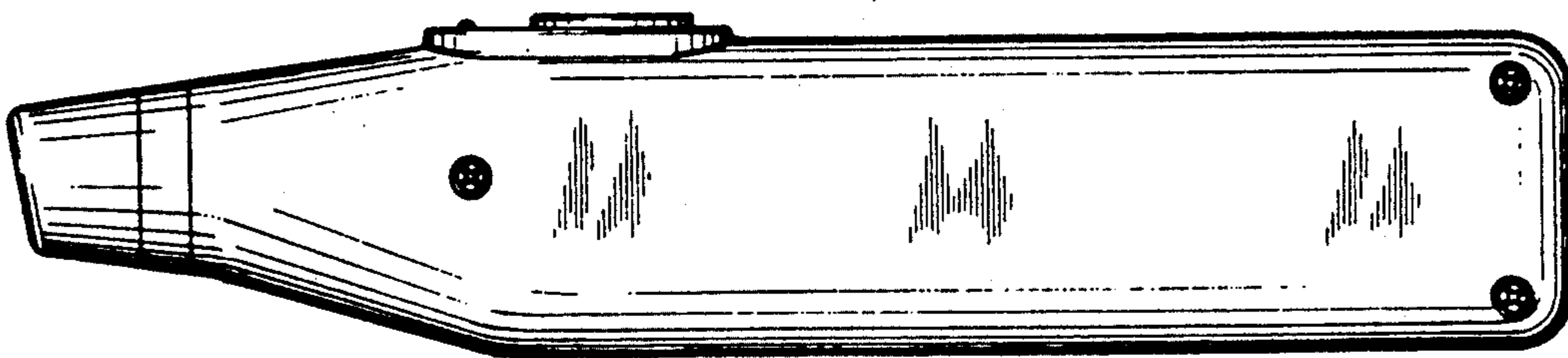
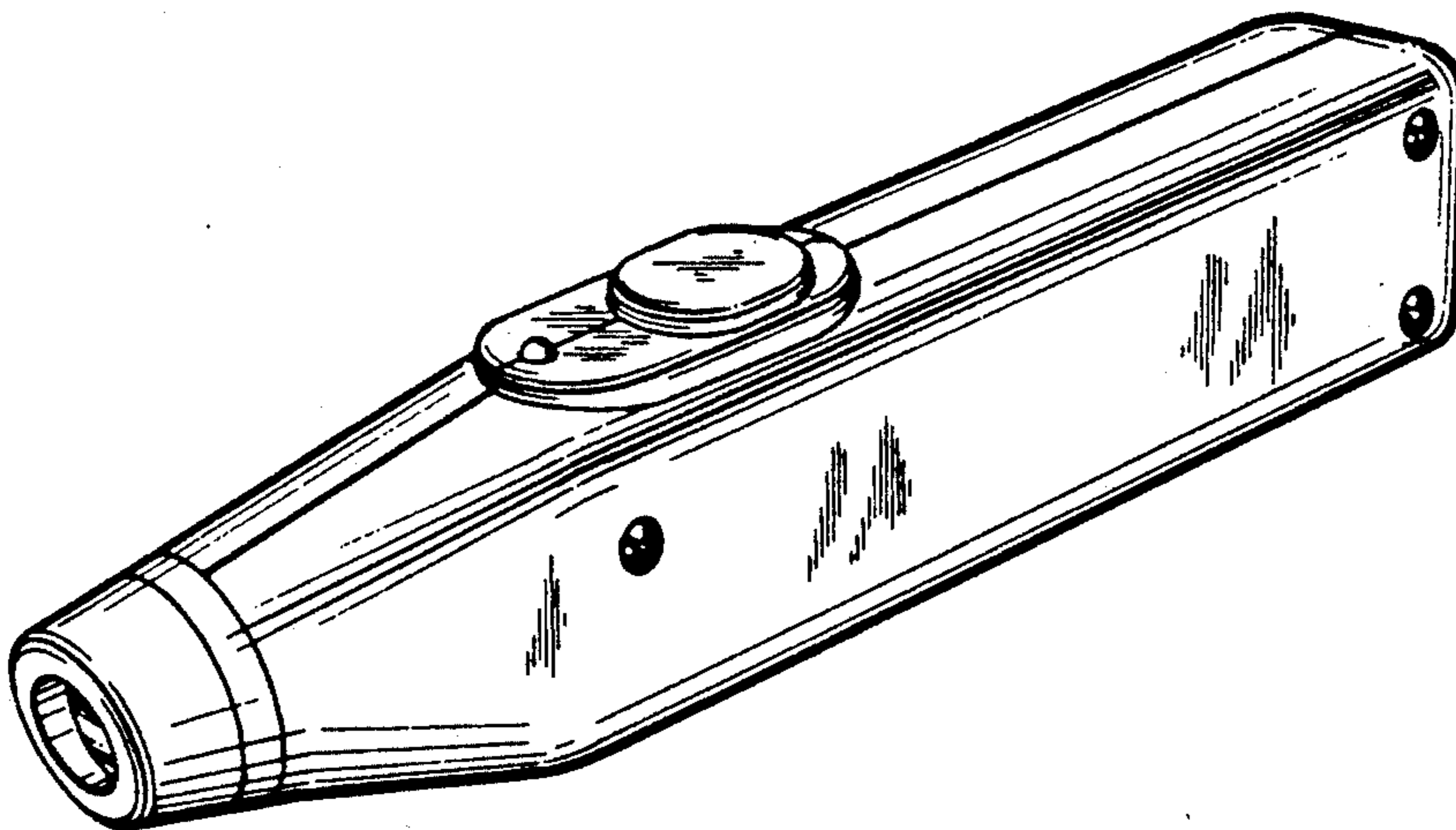

FIG. 1

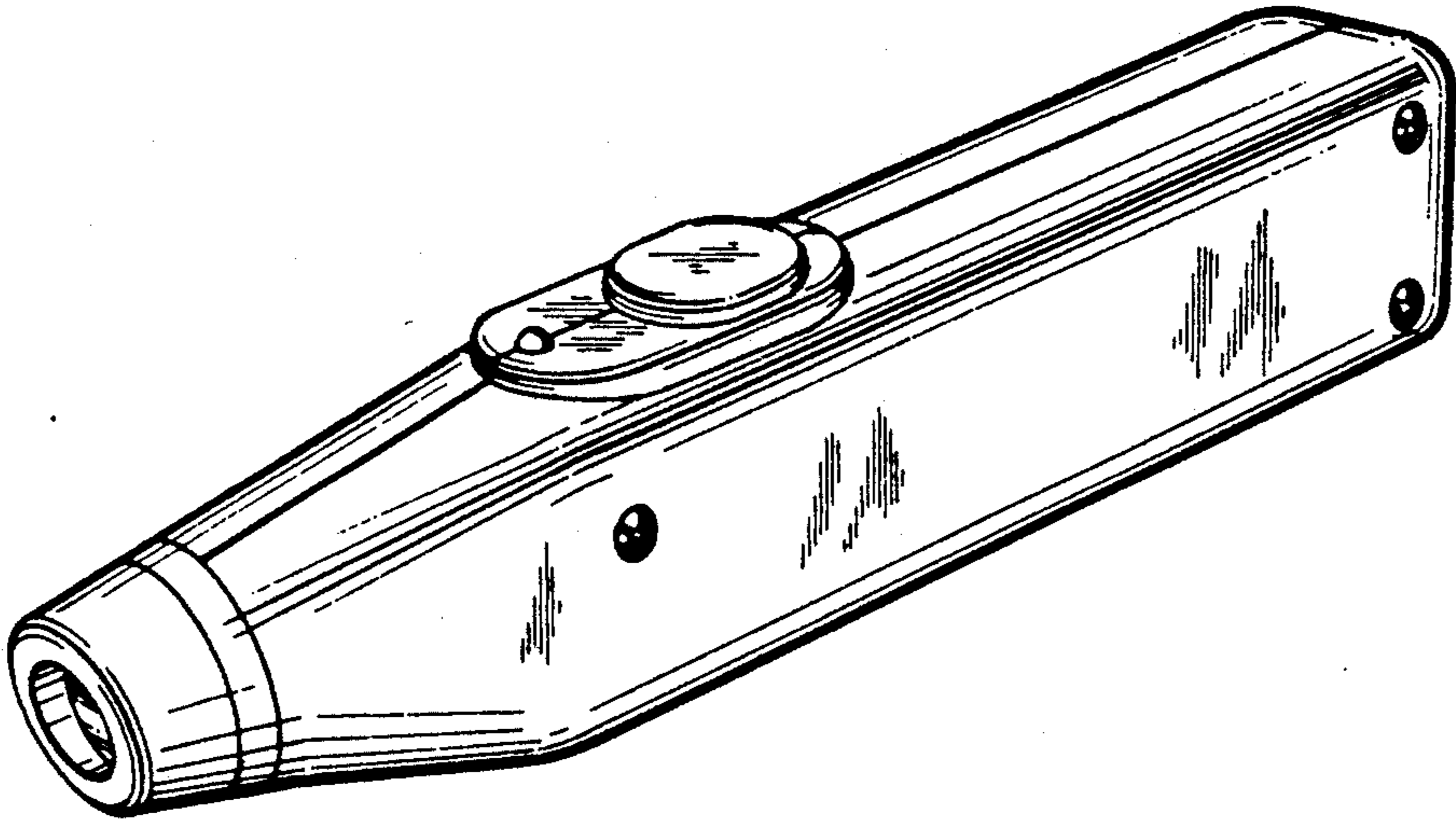

FIG. 2

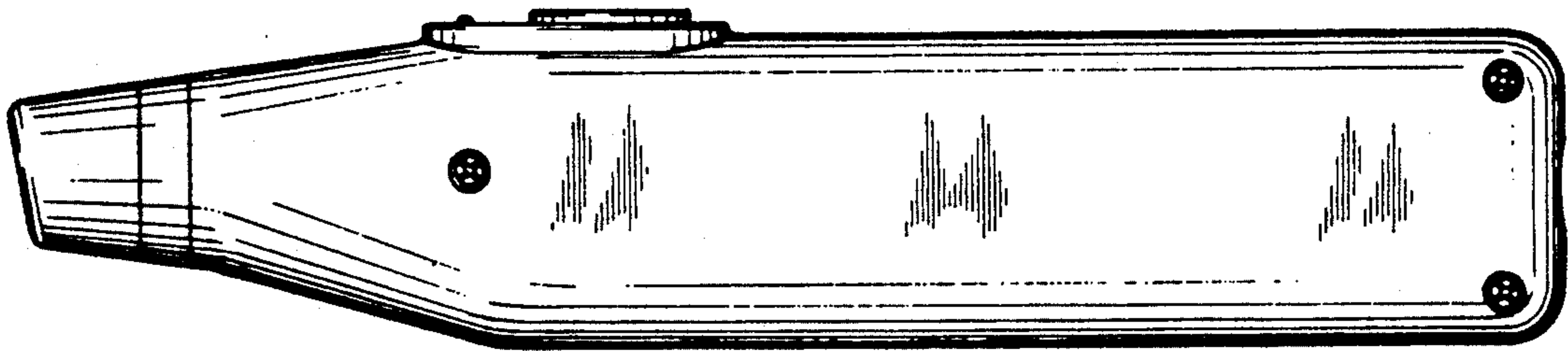

FIG. 3

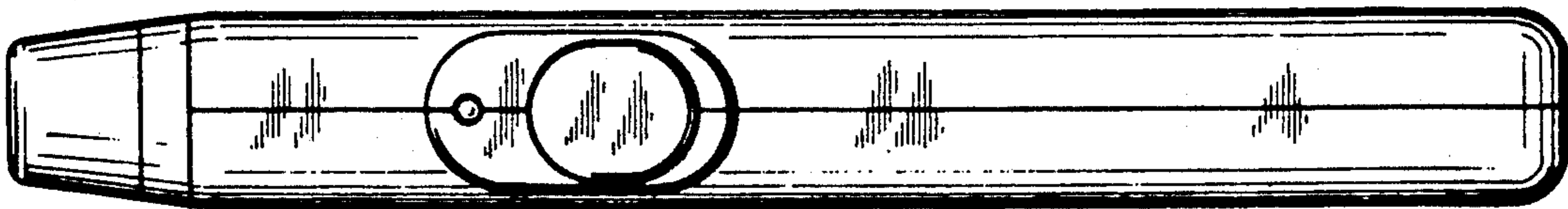

FIG. 4

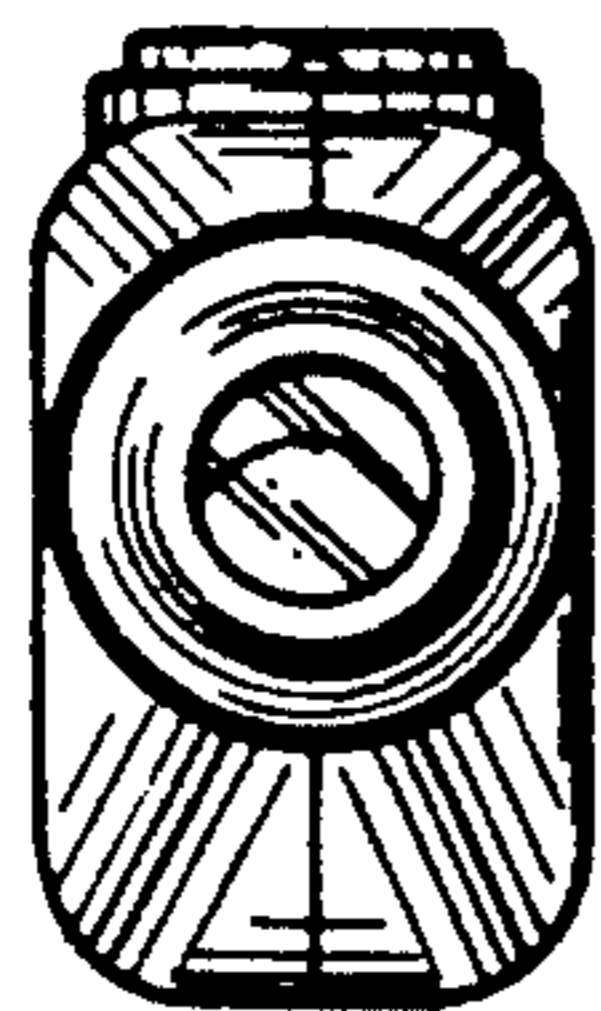

FIG. 5

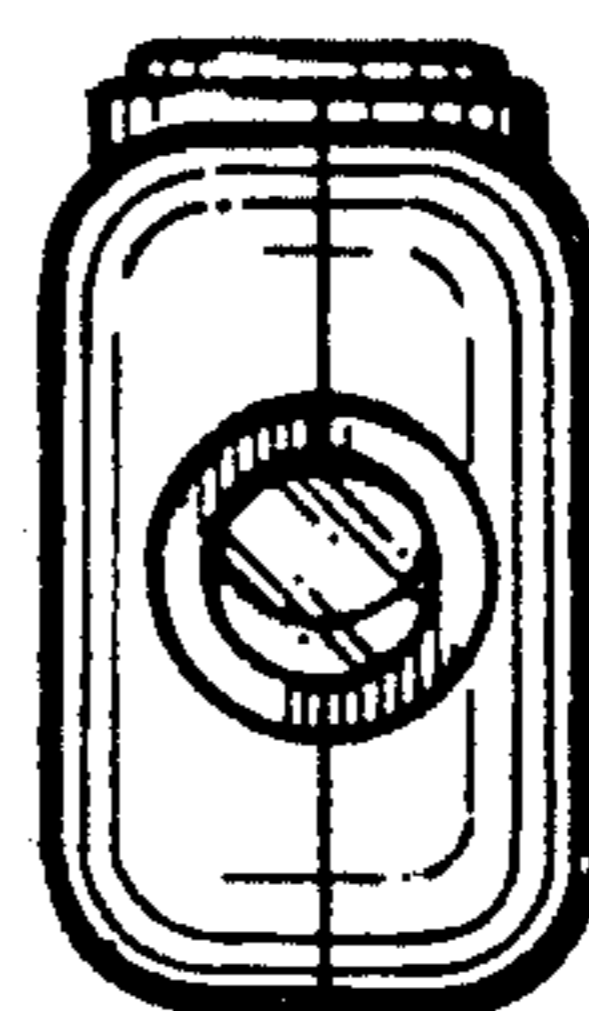

FIG. 6

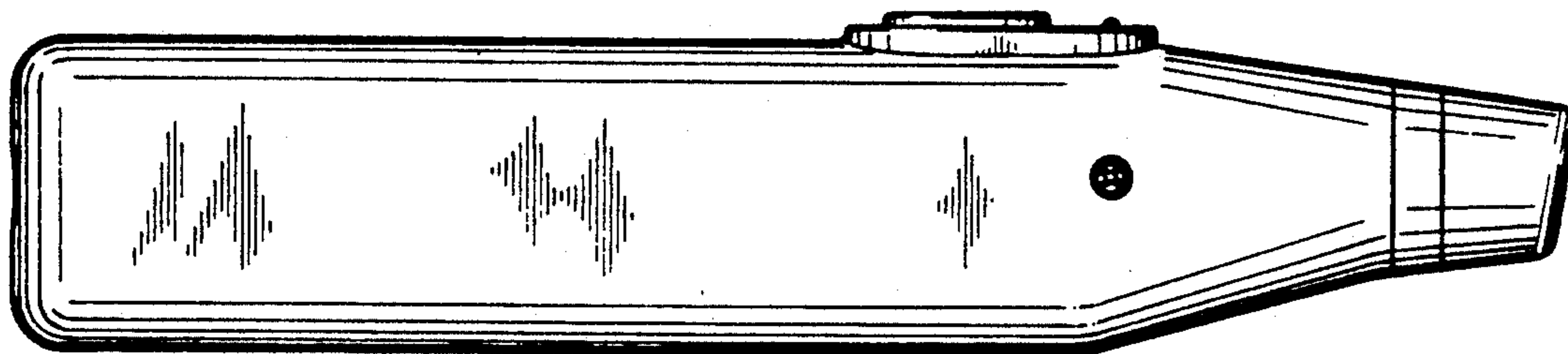

FIG. 7

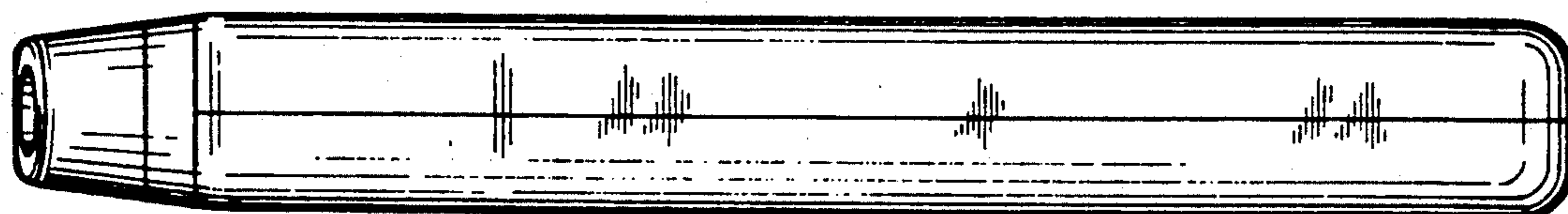

FIG. 8

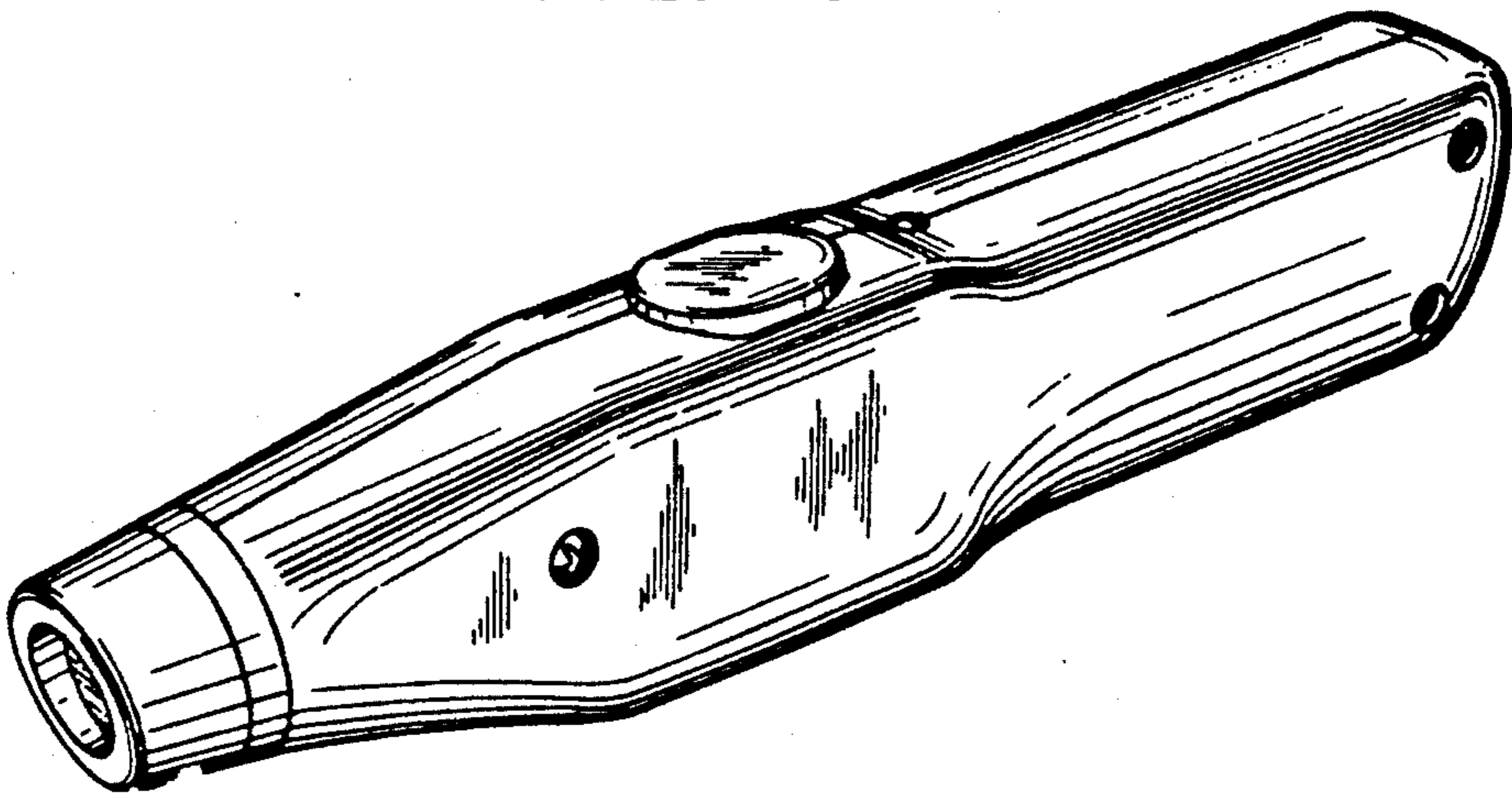

FIG. 9

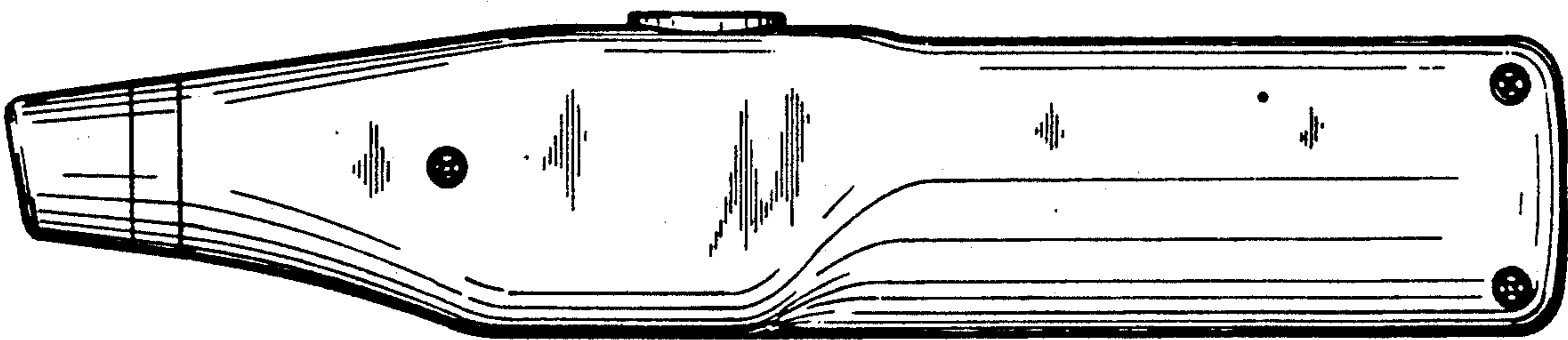

FIG. 10

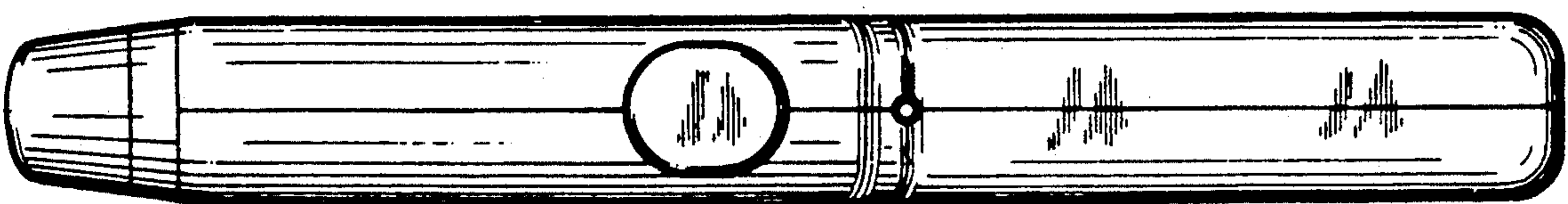

FIG. 11

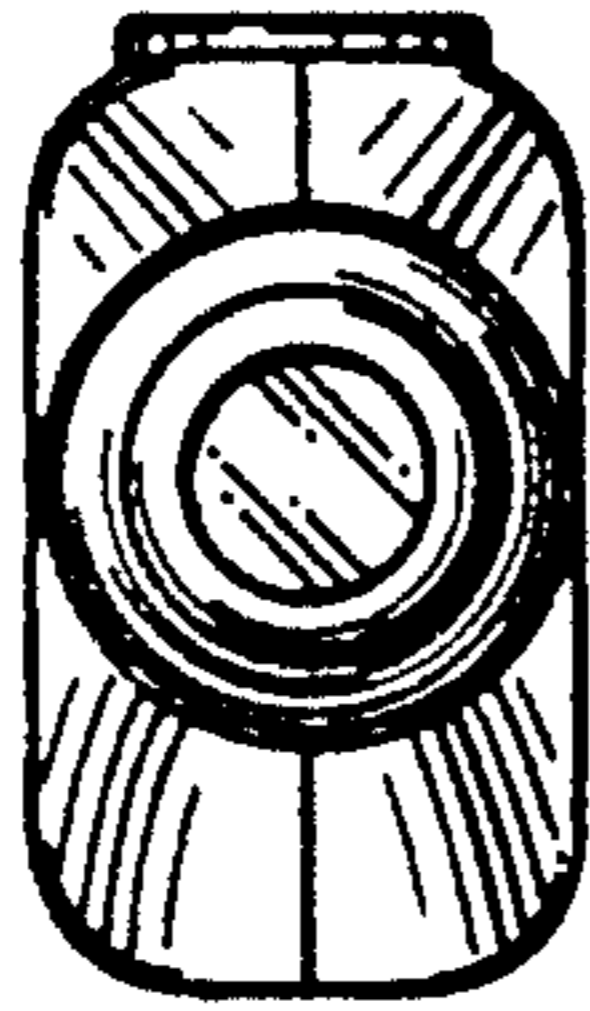

FIG. 12

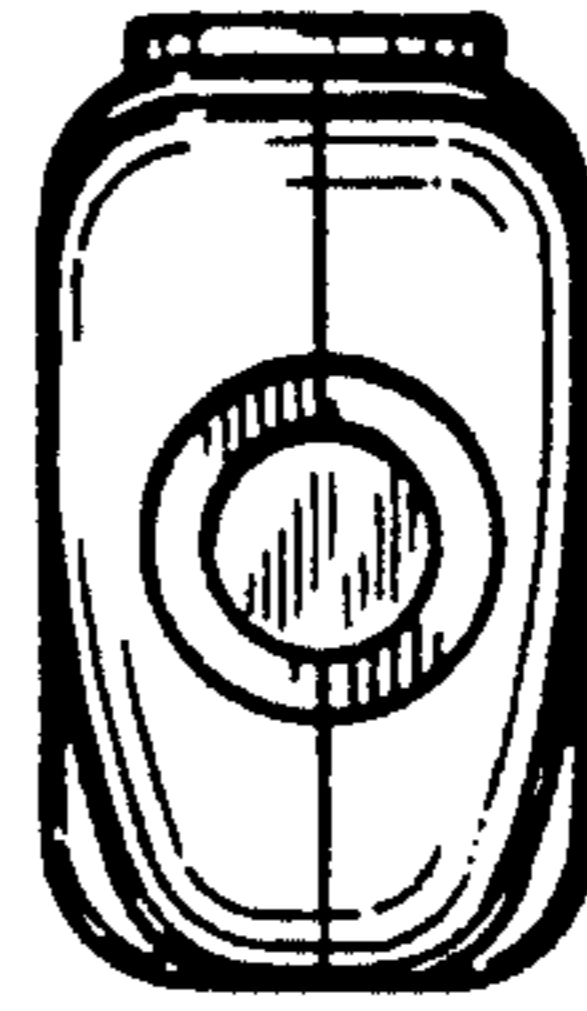

FIG. 13

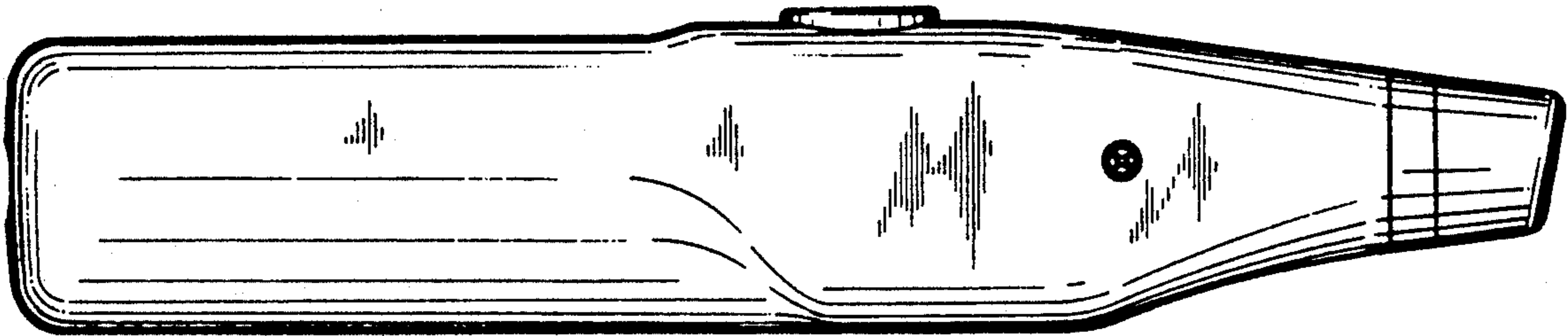

FIG. 14

