

[54] PORTABLE BLOWER

[75] Inventors: Martin P. Gierke; Robert P. Straub, both of Baltimore; Jonathan L. Miner, Timonium, all of Md.

[73] Assignee: Black & Decker Inc., Newark, Del.

[**] Term: 14 Years

[21] Appl. No.: 120,000

[22] Filed: Nov. 13, 1987

[52] U.S. Cl. D32/15

[58] Field of Search D32/1, 15-18, D32/25, 32; D23/383, 393; 15/404-405, 344, 414, 415 R, 415 A, 420, 330-331, 337, 335; 417/234, 423.2, 236

[56] References Cited

U.S. PATENT DOCUMENTS

D. 147,125	7/1947	Harvuot .	
D. 192,345	3/1962	Nerheim .	
D. 209,274	11/1967	Richards .	
D. 211,751	7/1968	Richards .	
D. 255,864	7/1980	Bennett .	
D. 258,908	4/1981	Satoh	D23/155
D. 266,355	9/1982	Mariol	D23/383
D. 266,587	10/1982	Satoh	D23/155
D. 280,661	9/1985	Hill	D23/383
D. 297,274	8/1988	Komiya et al.	D32/15
2,068,496	1/1937	Linghammar	15/155
4,132,507	1/1979	Akiyama et al.	417/234
4,269,571	5/1981	Shikutani et al.	417/234
4,288,886	9/1981	Siegler	15/330
4,413,371	11/1983	Tuggle et al.	15/405
4,734,017	3/1988	Levin	417/366

OTHER PUBLICATIONS

Hardware Age, vol. 220, Dec. 1983, p. 472.

Primary Examiner—A. Hugo Word

Assistant Examiner—Doris V. Coles

Attorney, Agent, or Firm—Charles E. Yocum; Dennis A. Dearing; John D. Del Ponti

[57] CLAIM

The ornamental design for a portable blower, as shown and described.

DESCRIPTION

FIG. 1 is a perspective view of a portable blower showing our new design;

FIG. 2 is a side elevational view thereof;

FIG. 3 is a top plan view thereof;

FIG. 4 is a bottom plan view thereof;

FIG. 5 is a front elevational view thereof;

FIG. 6 is a rear elevational view thereof;

FIG. 7 is a perspective view of the second embodiment, with the cord cut away for the convenience of illustration;

FIG. 8 is a side elevational view thereof;

FIG. 9 is a top plan view thereof;

FIG. 10 is a bottom plan view thereof;

FIG. 11 is a front elevational view thereof;

FIG. 12 is a rear elevational view thereof;

FIG. 13 is a partial rear elevational view of the first embodiment, with the guard removed;

FIG. 14 is a side elevational view of the third embodiment;

FIG. 15 is a partial side elevational view thereof;

FIG. 16 is a front elevational view thereof;

FIG. 17 is a partial side elevation view of the rear portion; and

FIG. 18 is a rear elevational view.

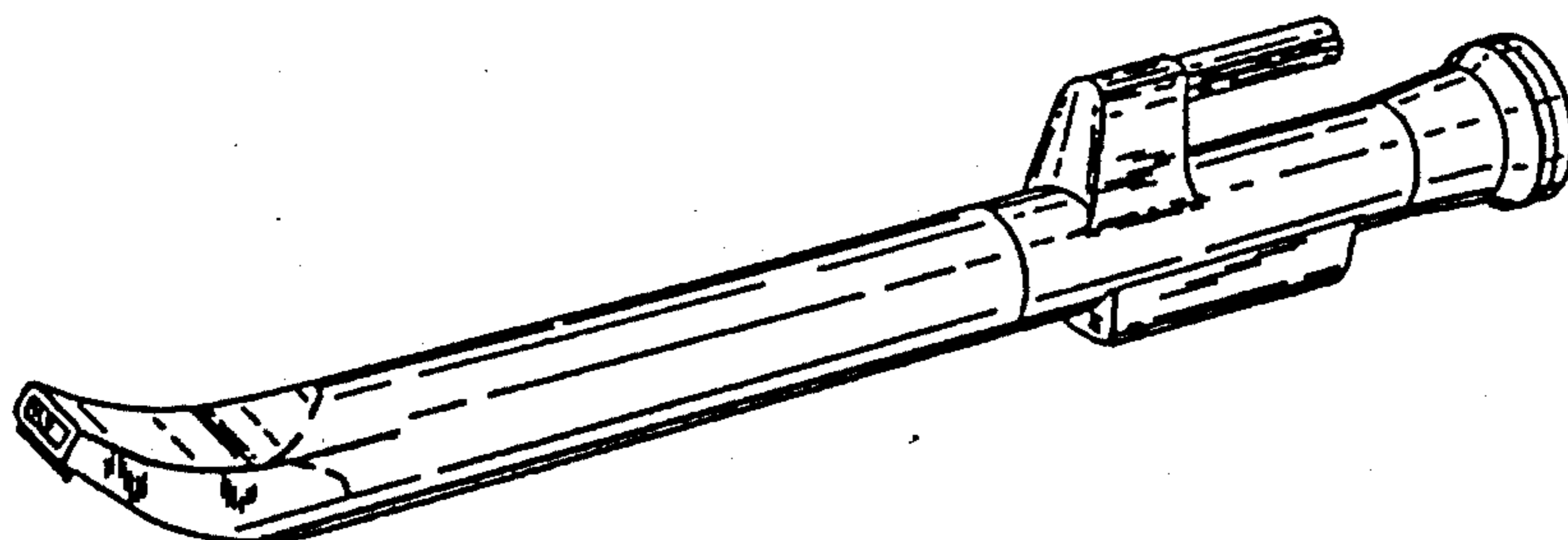

FIG. 1

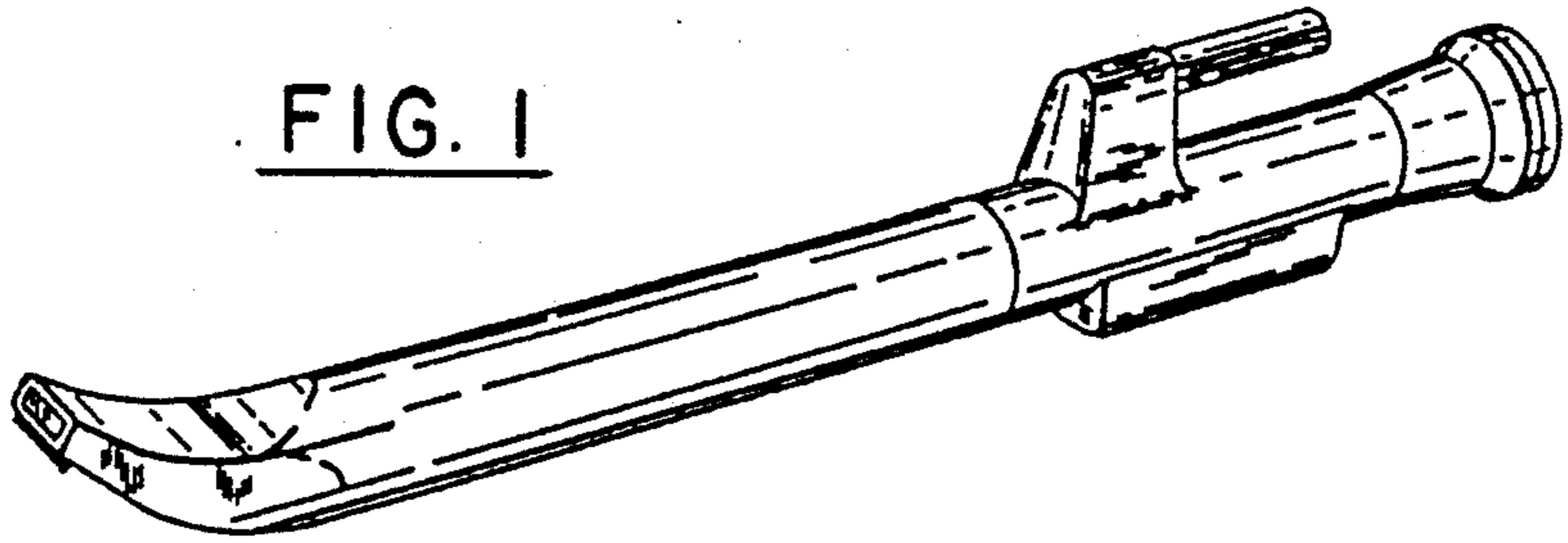

FIG. 2

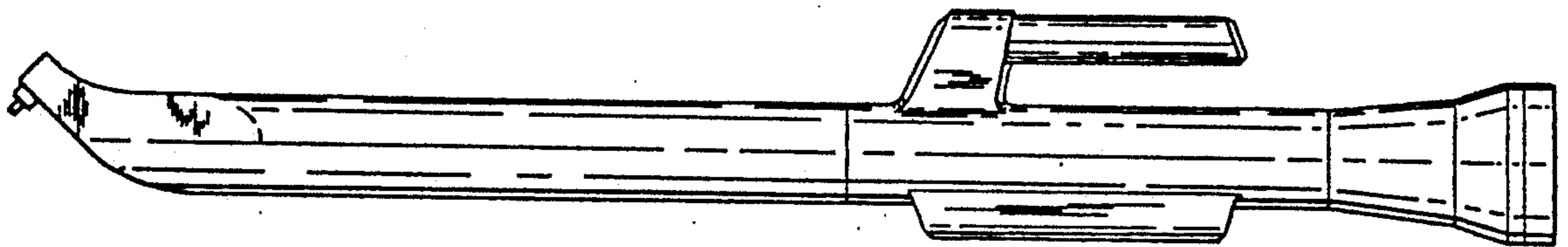

FIG. 3

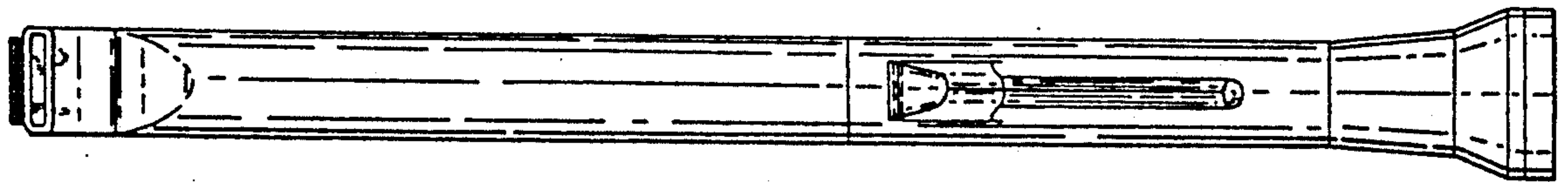

FIG. 4

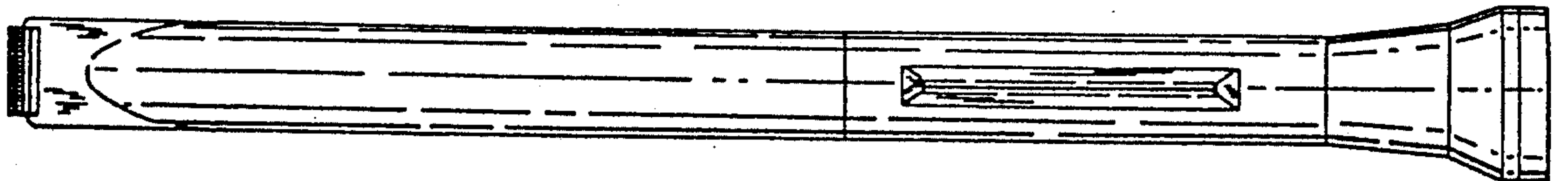

FIG. 5

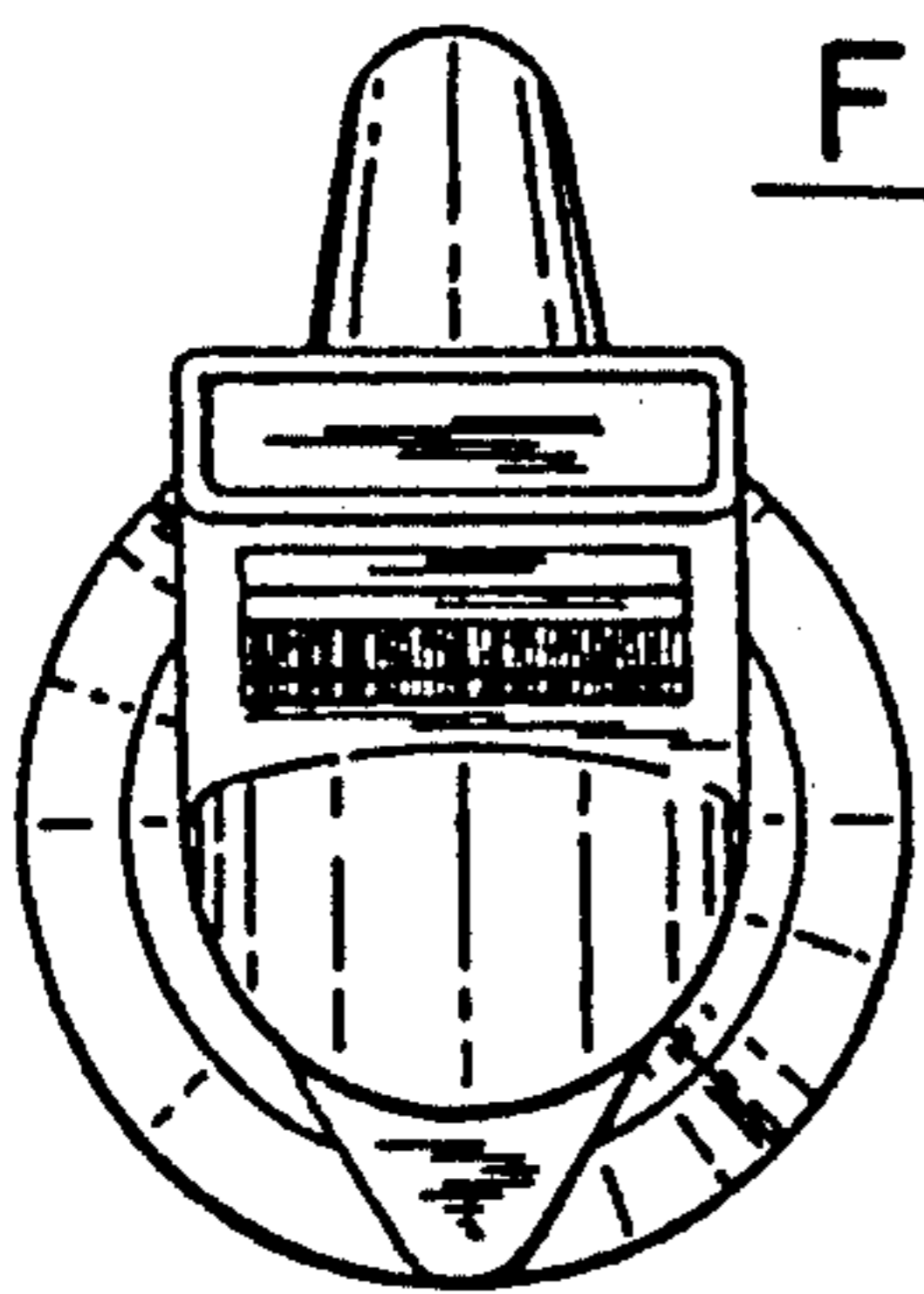

FIG. 6

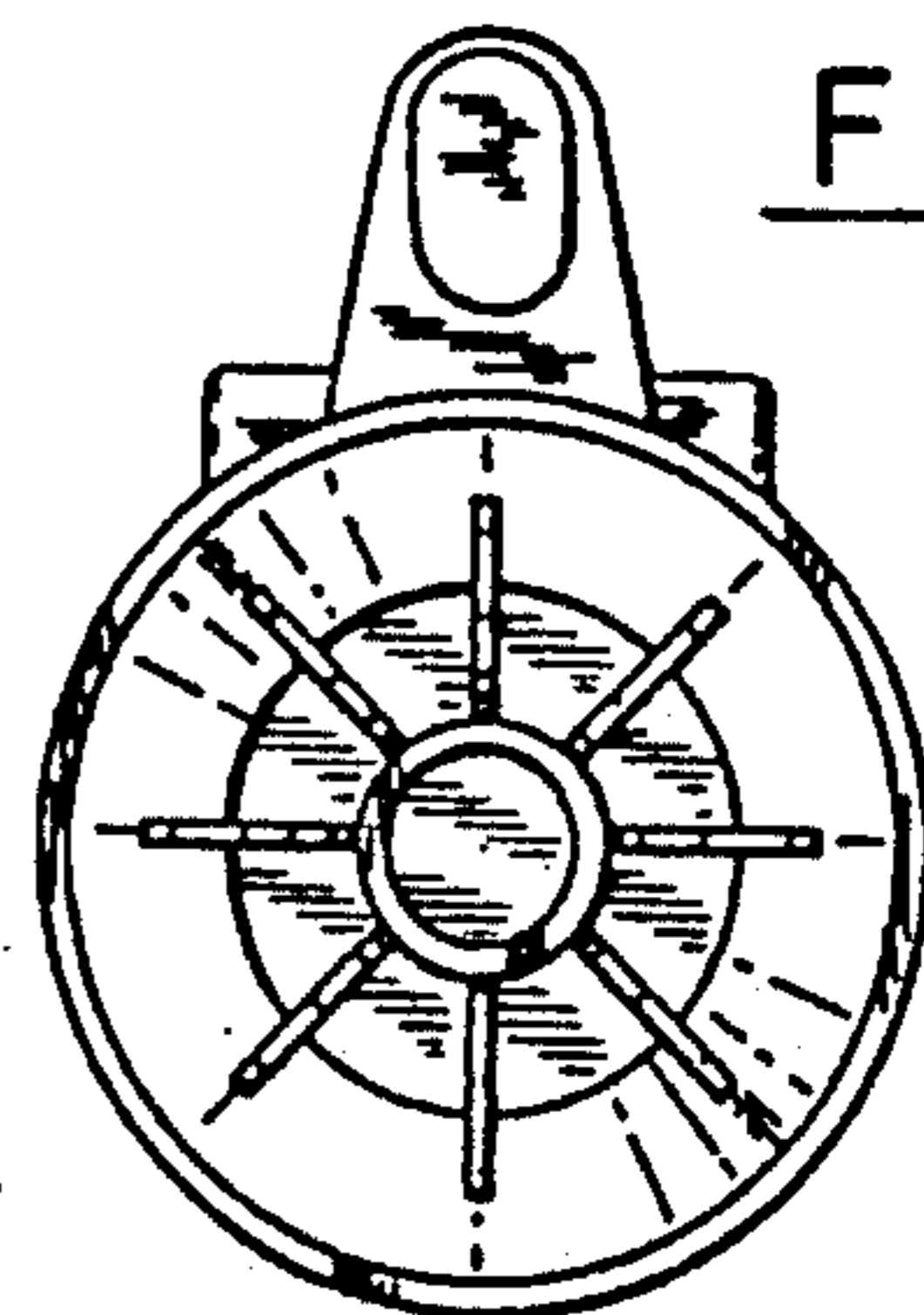

FIG. 7

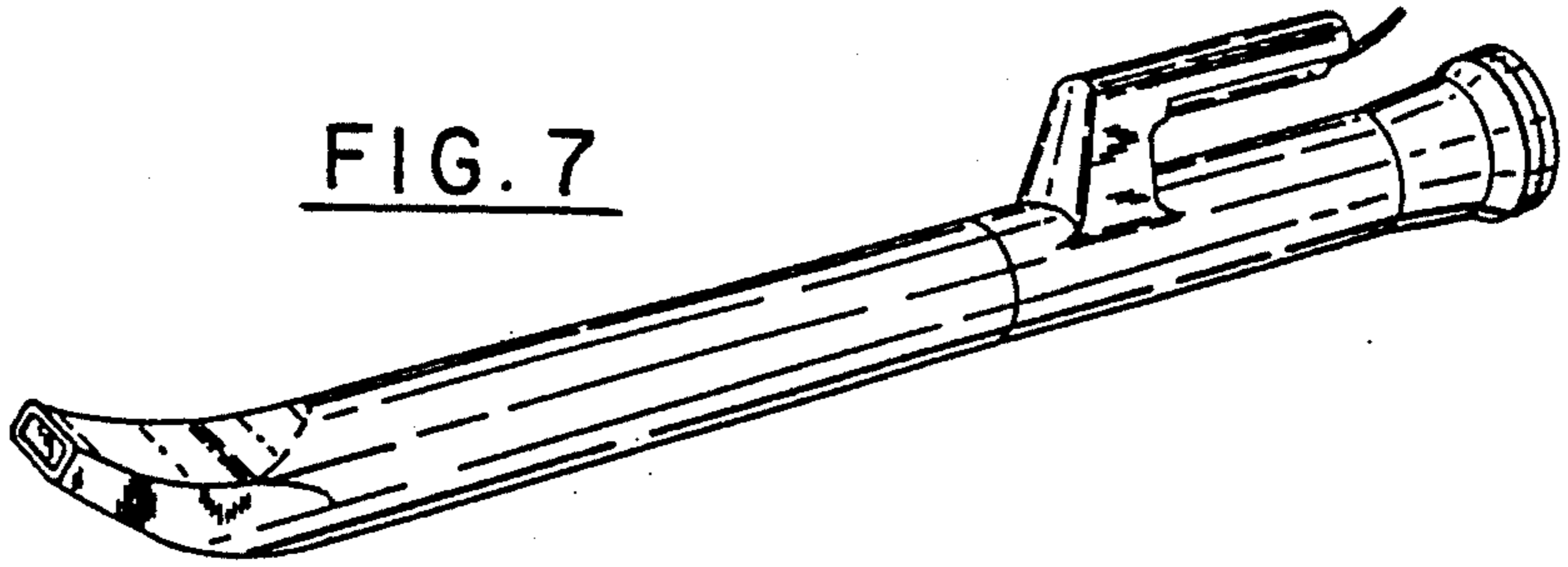

FIG. 8

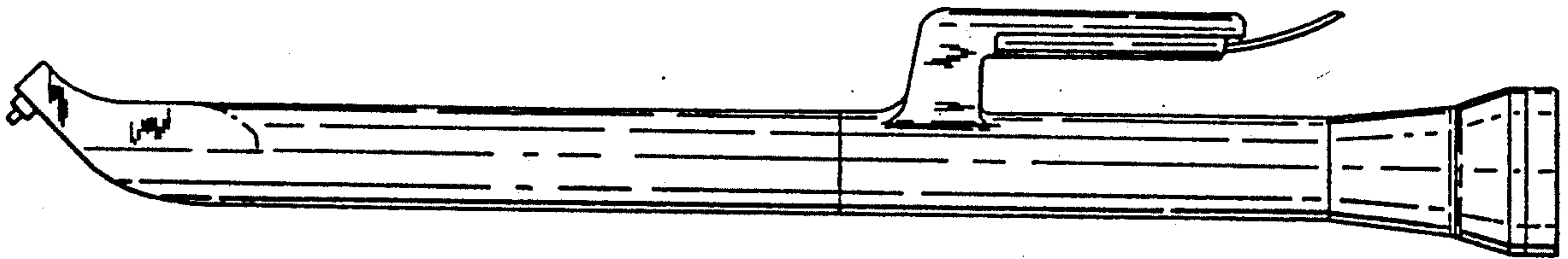

FIG. 9

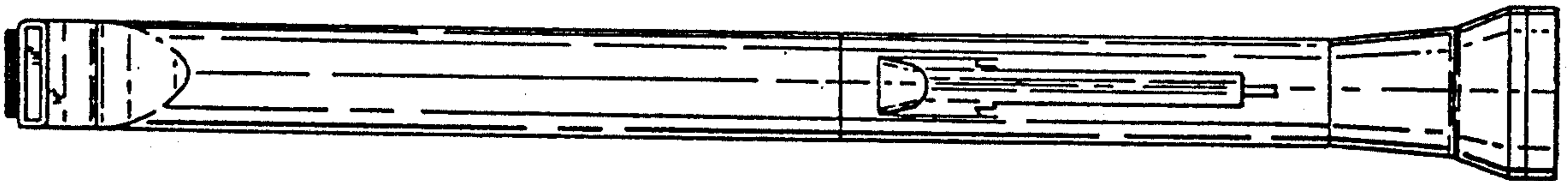

FIG. 10

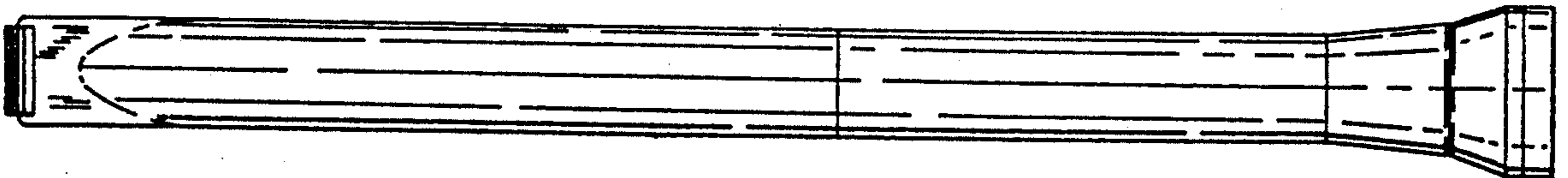

FIG. 11

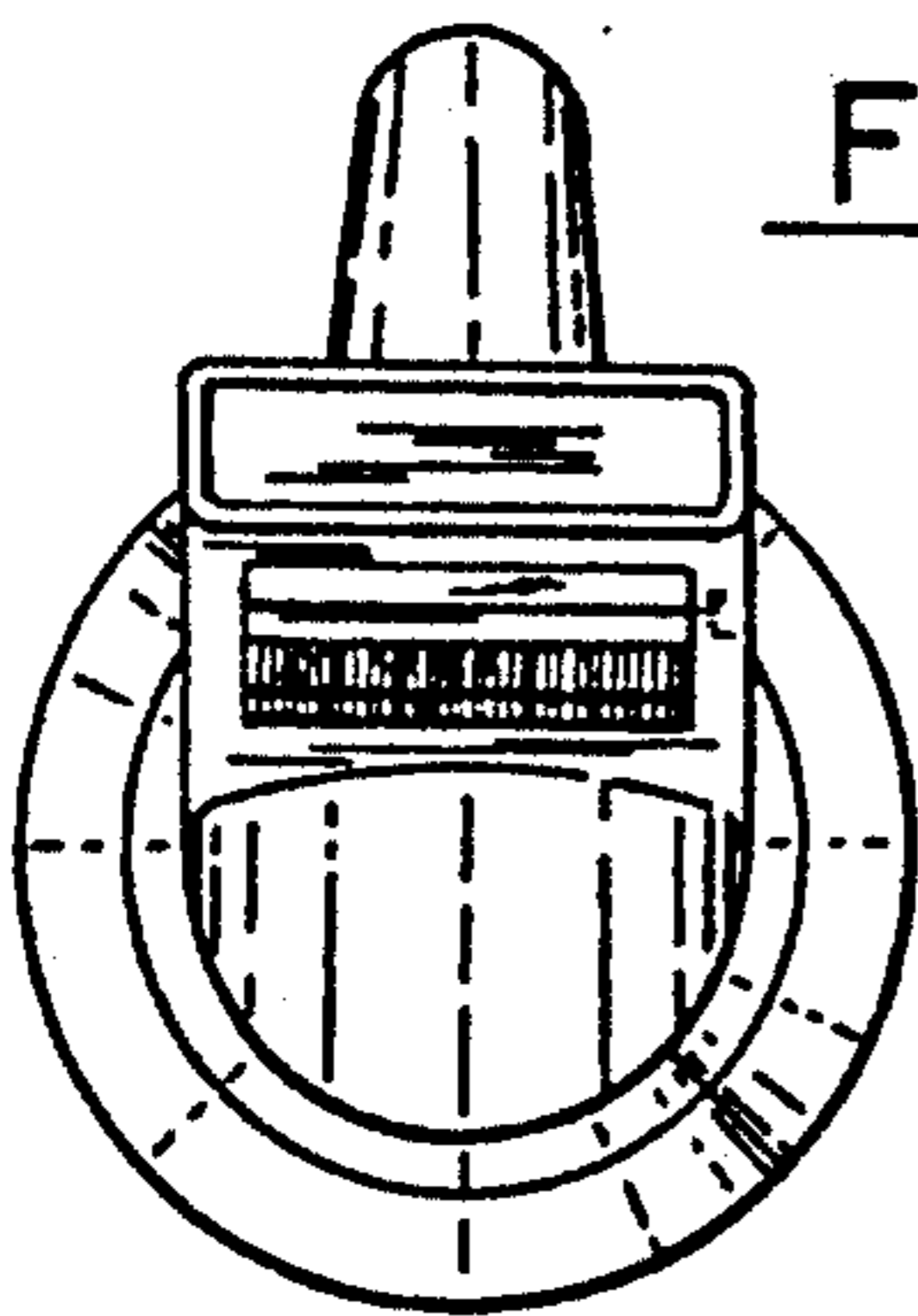
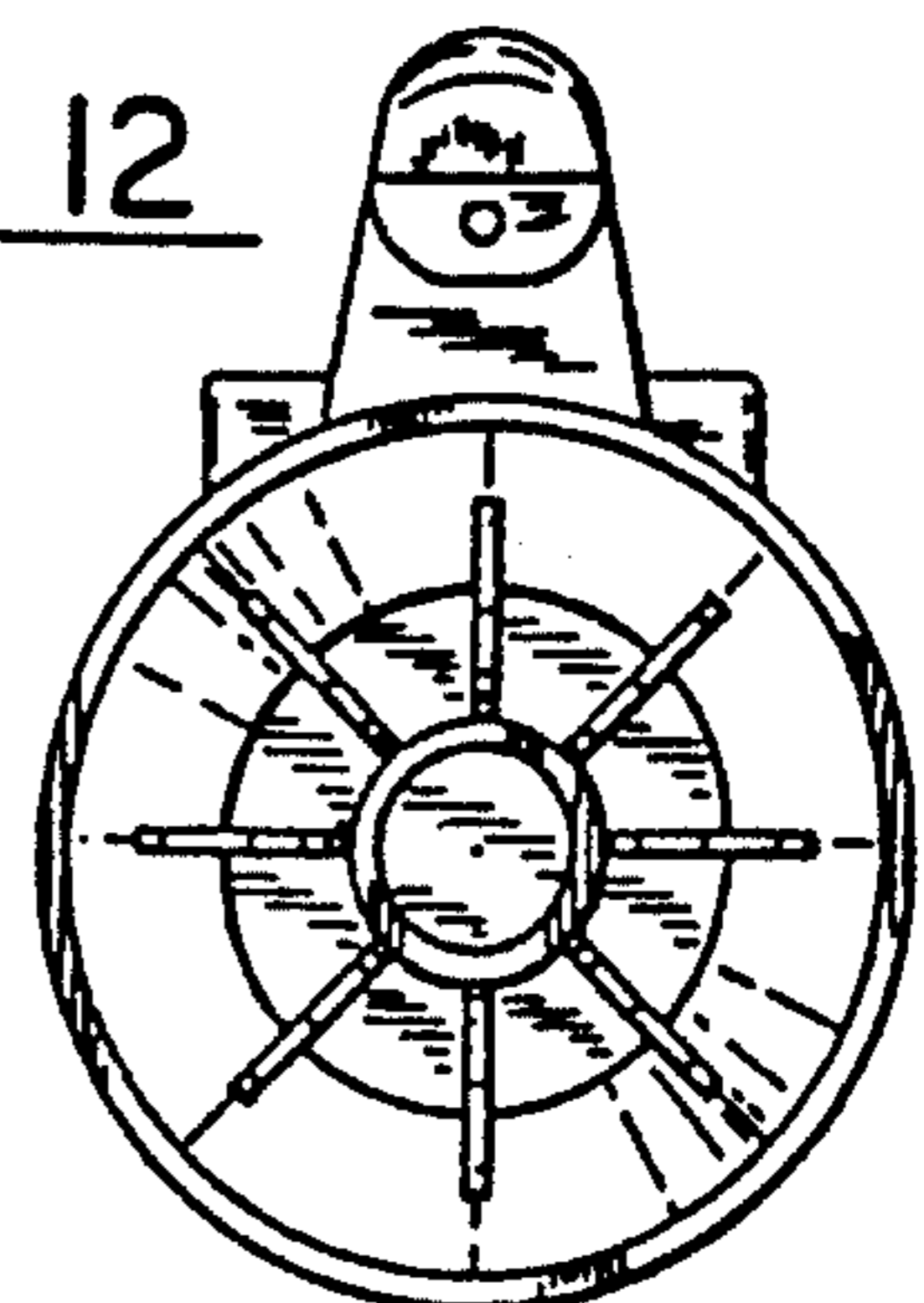

FIG. 12



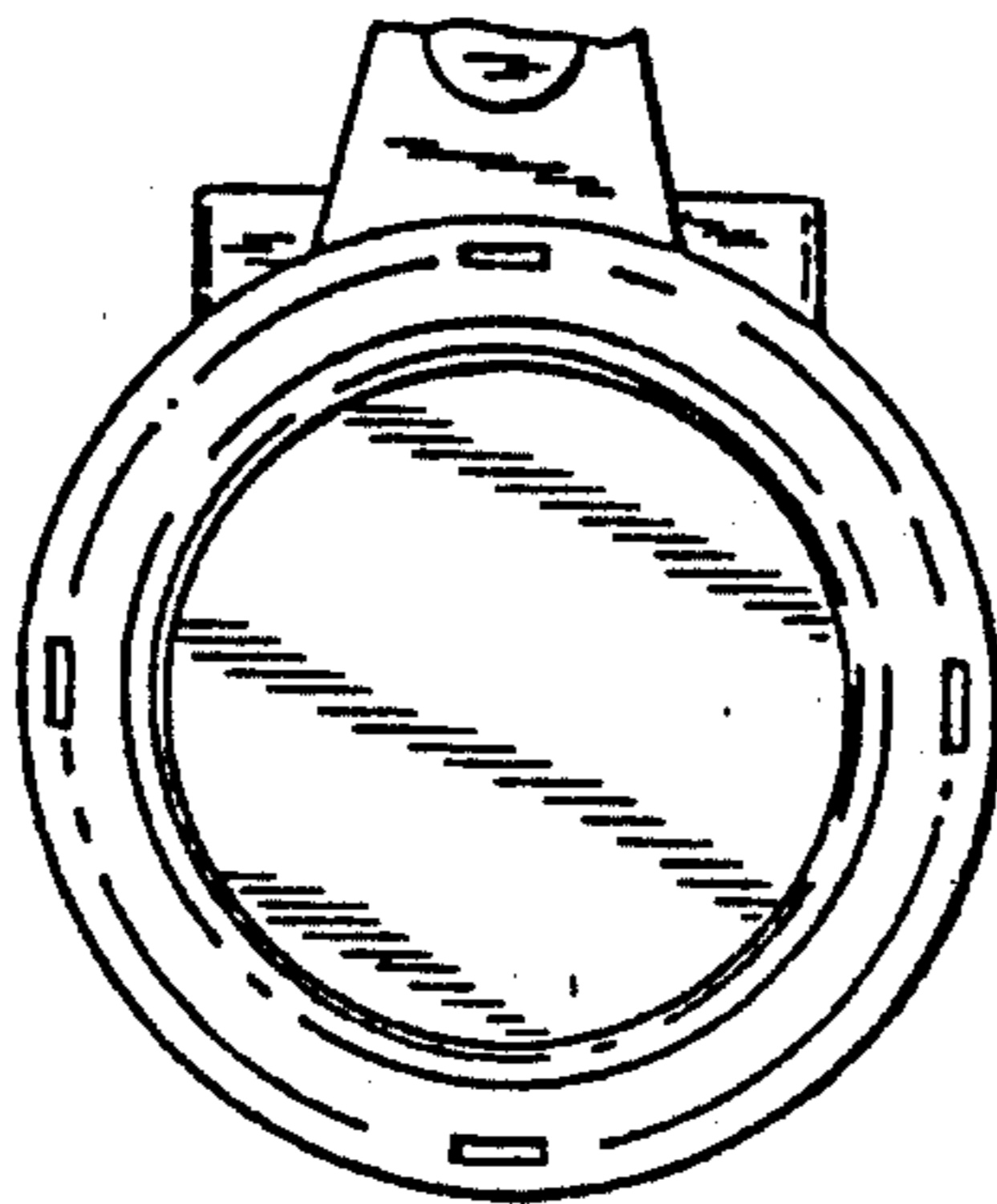

FIG. 13

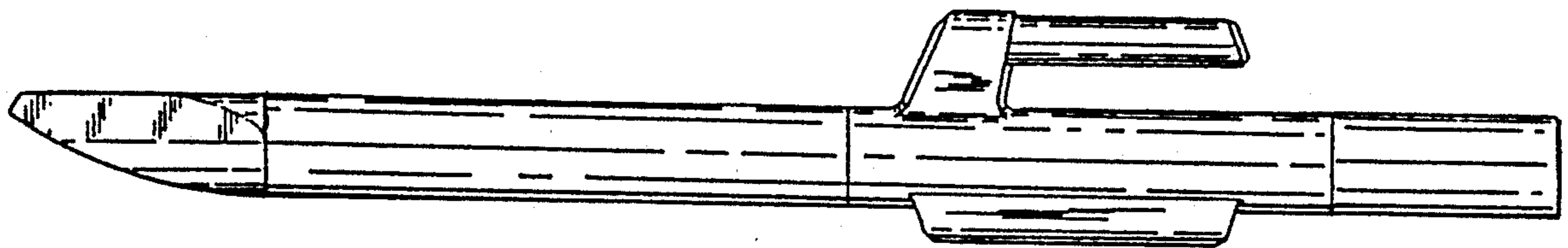

FIG. 14

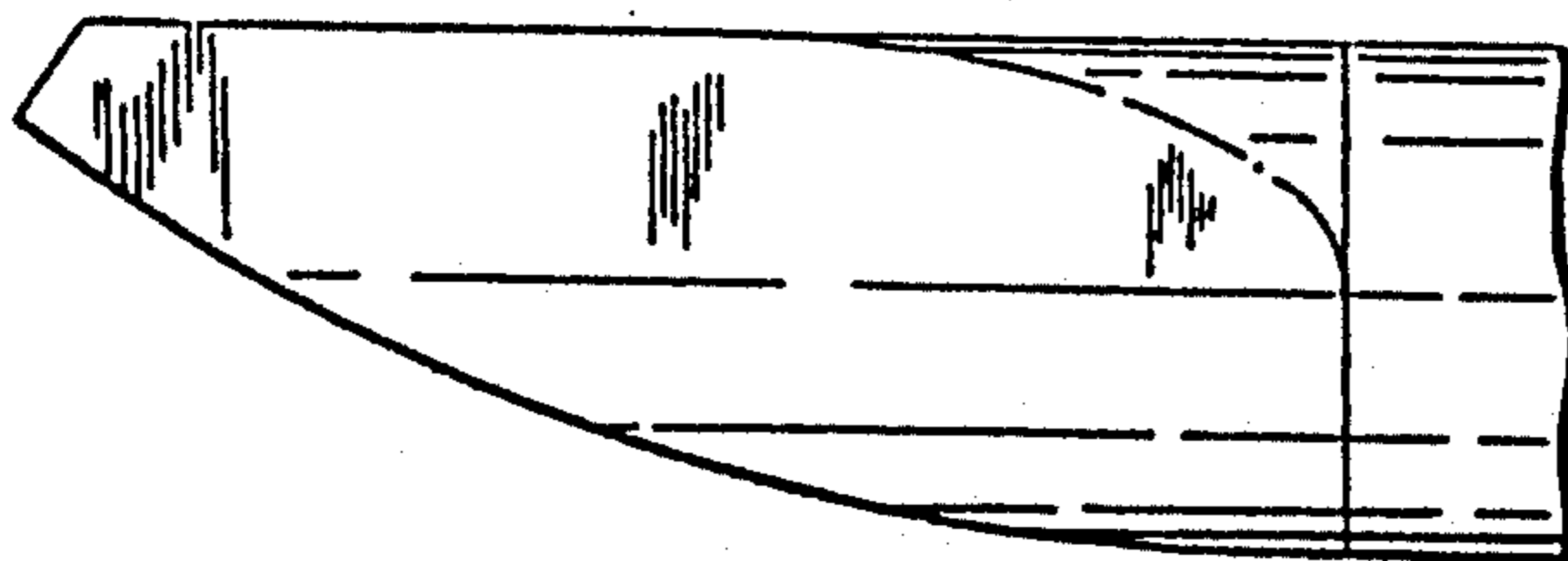

FIG. 15

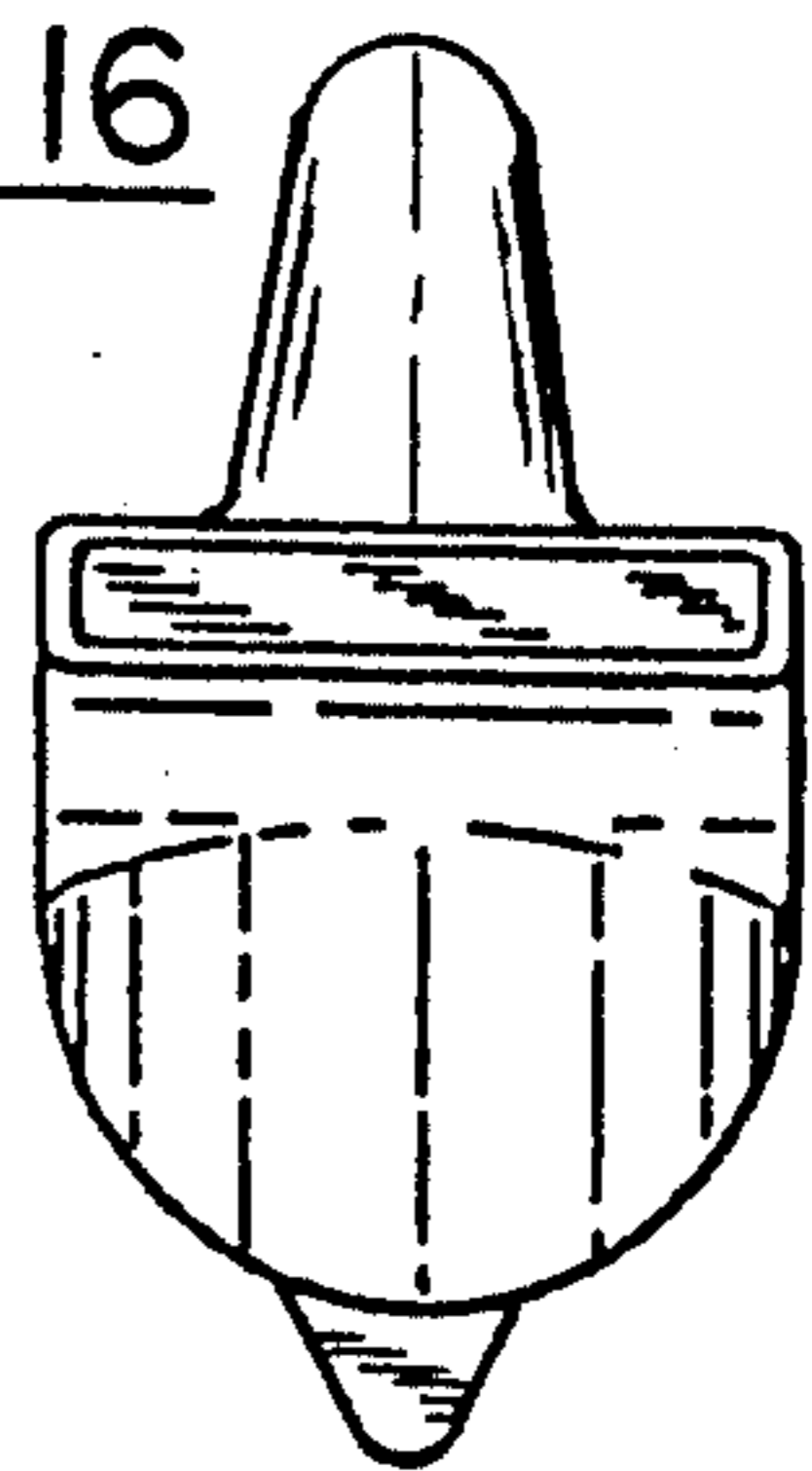

FIG. 16

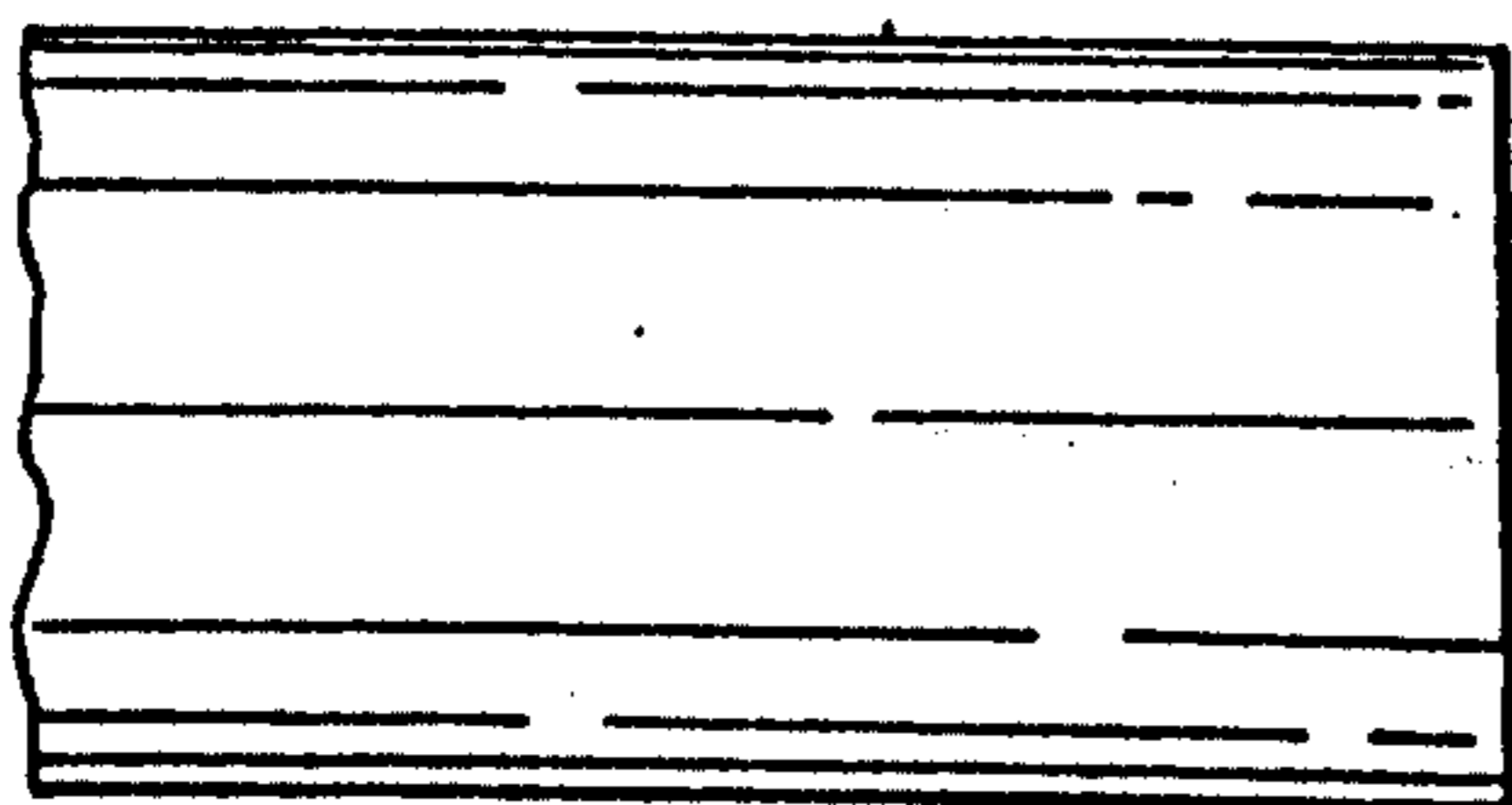

FIG. 17

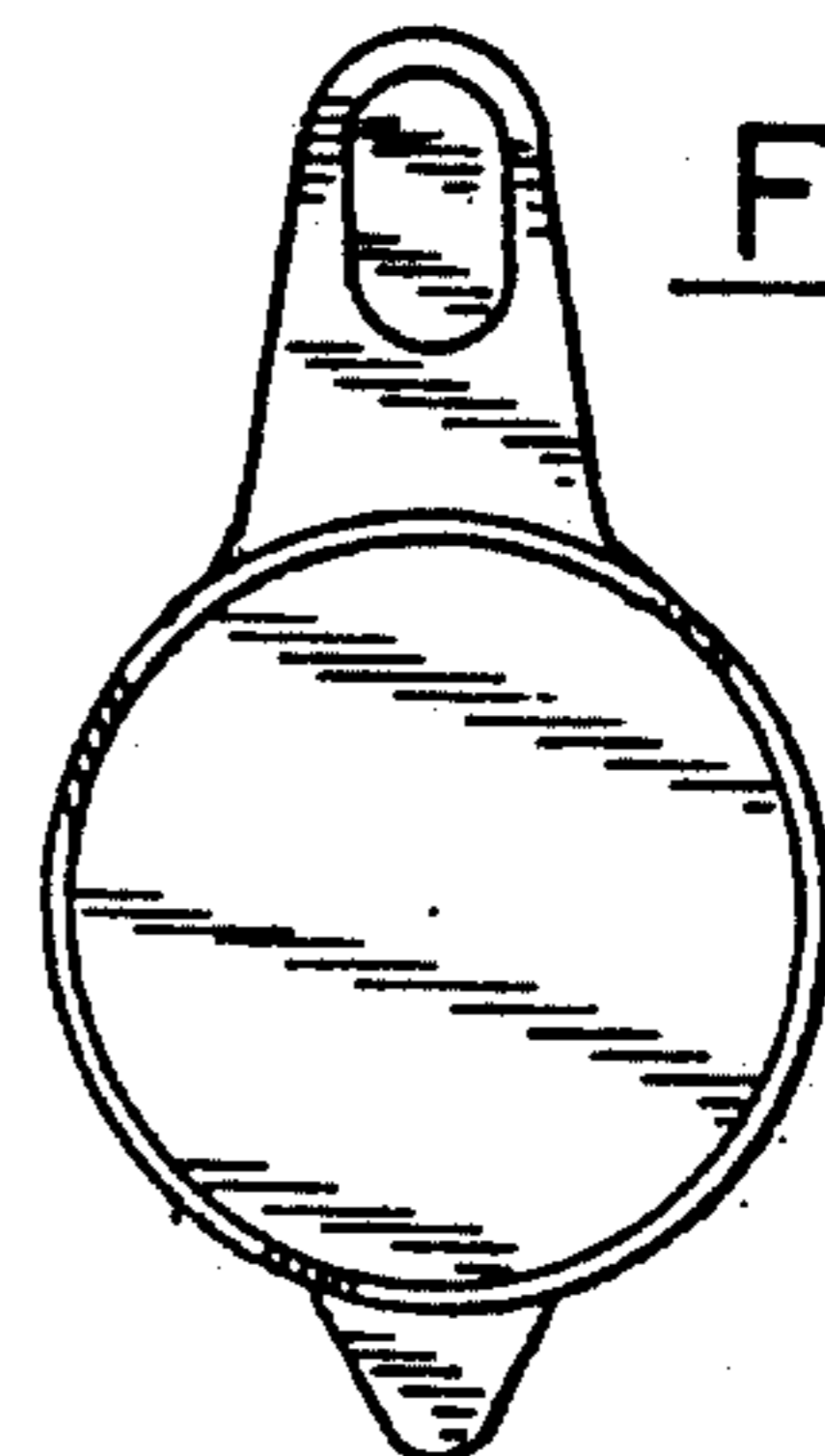

FIG. 18