

# United States Patent [19]

Sandel et al.

[11] Patent Number: **Des. 319,111**

[45] Date of Patent: **\*\* Aug. 13, 1991**

[54] **COMBINED FACE MASK AND SHIELD**

[75] Inventors: **James L. Sandel, Birmingham; Frank L. Lee, Hueytown, both of Ala.**

[73] Assignee: **BFD Industries, Inc., British Columbia, Canada**

[\*\*] Term: **14 Years**

[21] Appl. No.: **399,276**

[22] Filed: **Aug. 28, 1989**

[52] U.S. Cl. .... **D29/9; D29/8**

[58] Field of Search ..... **D29/6, 7, 8, 9; 128/206.23, 206.15, 206.24, 207.11, 146**

[56] **References Cited**

**U.S. PATENT DOCUMENTS**

- D. 311,789 10/1990 Villarreal et al. .... D29/9
- 2,462,005 2/1949 Schauweker ..... 128/207.11
- 2,745,401 5/1956 Cupp ..... 128/207.11

- 4,077,068 3/1978 Anderson ..... 128/207.11
- 4,807,619 2/1989 Dyrud et al. .... 128/206.16

**FOREIGN PATENT DOCUMENTS**

- 8910106 11/1989 World Int. Prop. O. .... D29/9

*Primary Examiner*—Kay H. Chin  
*Attorney, Agent, or Firm*—George A. Bode

[57] **CLAIM**

The ornamental design for a combined face mask and shield, as shown and described.

**DESCRIPTION**

FIG. 1 is a front and side perspective view of a combined face mask and shield showing our new design; FIG. 2 is a front elevational view thereof; FIG. 3 is a top plan view thereof; FIG. 4 is a side elevational view thereof, the side opposite being a mirror of that shown; FIG. 5 is a rear elevational view thereof; and, FIG. 6 is a bottom plan view thereof.

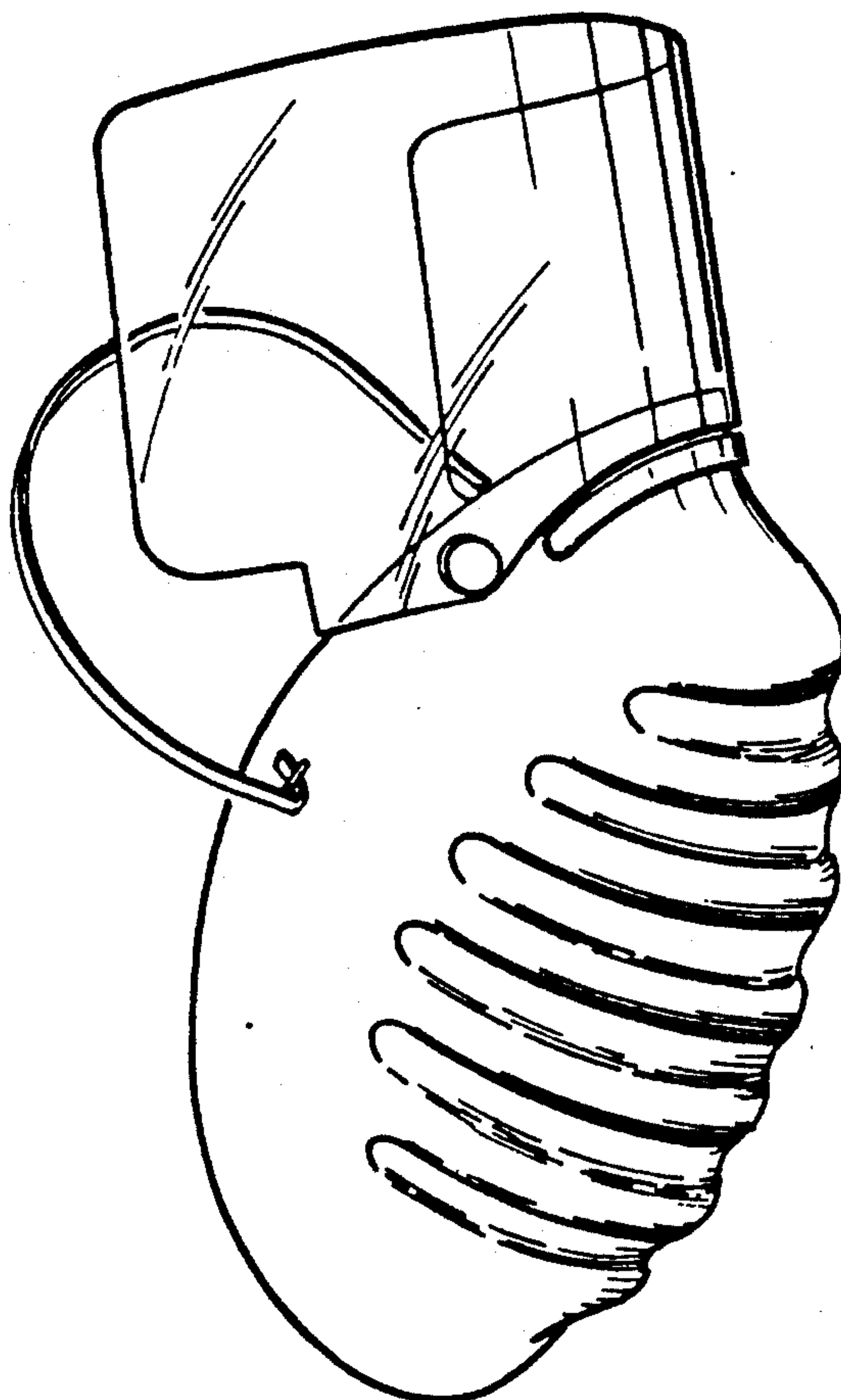

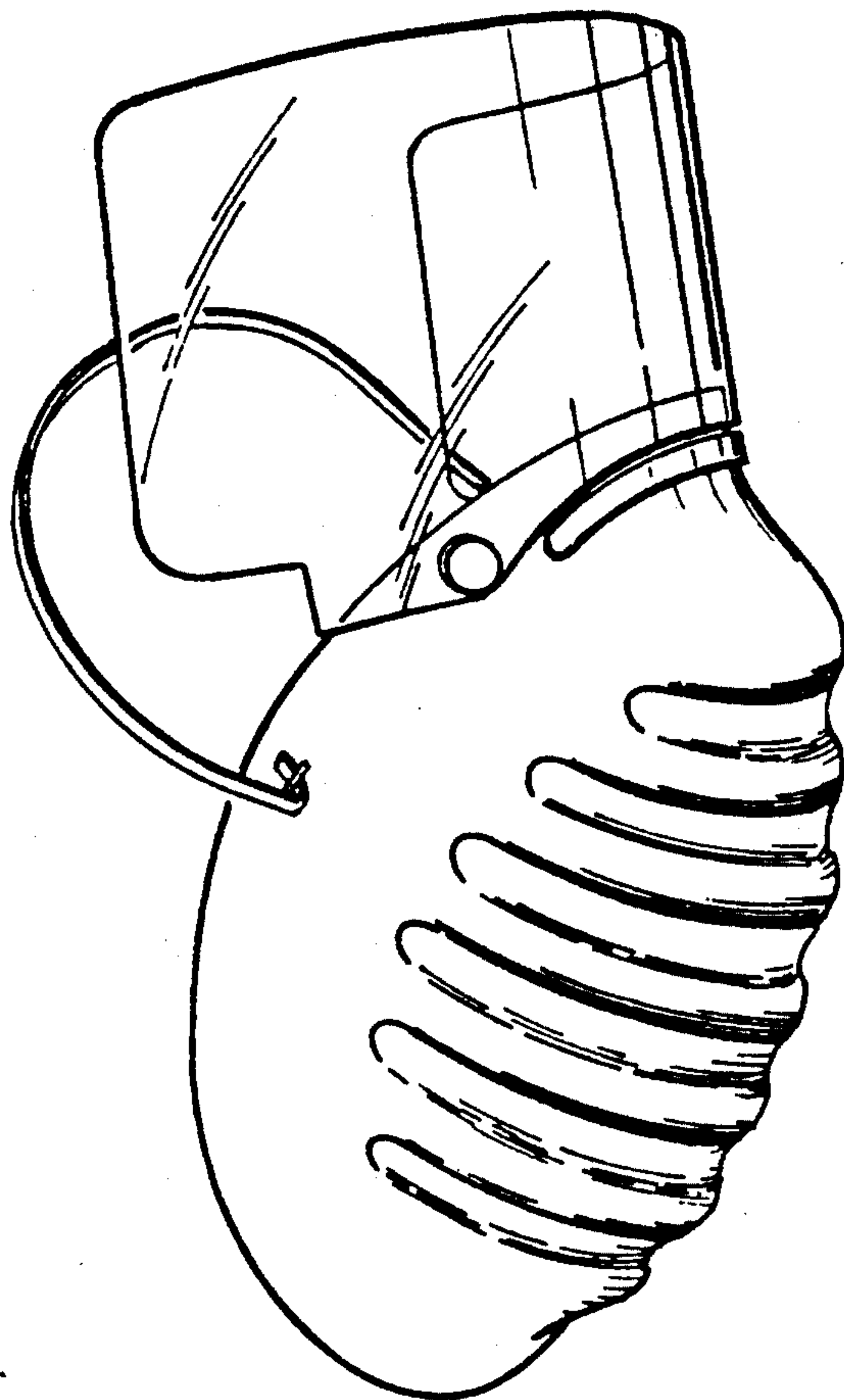

FIG. 1

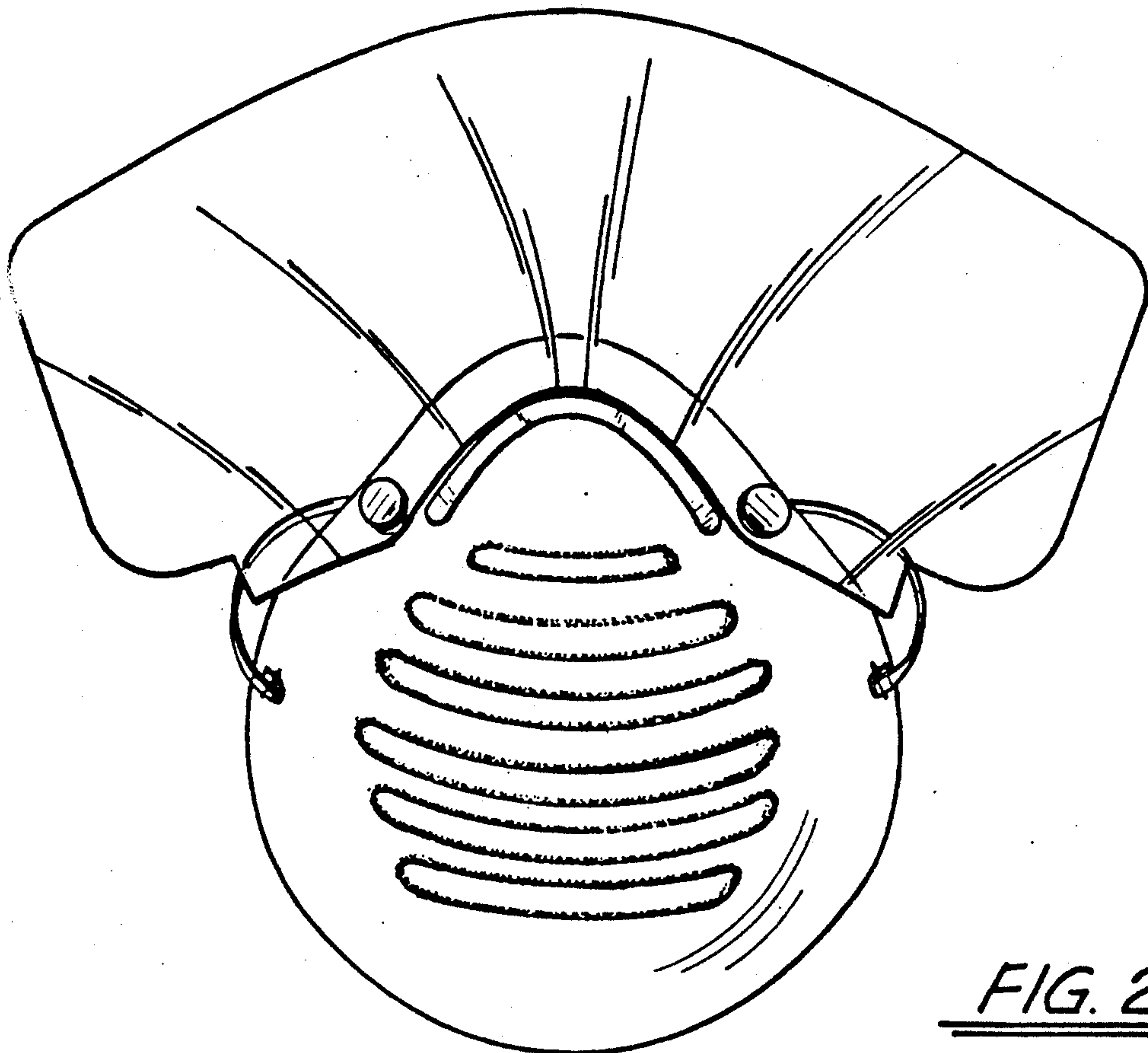

FIG. 2

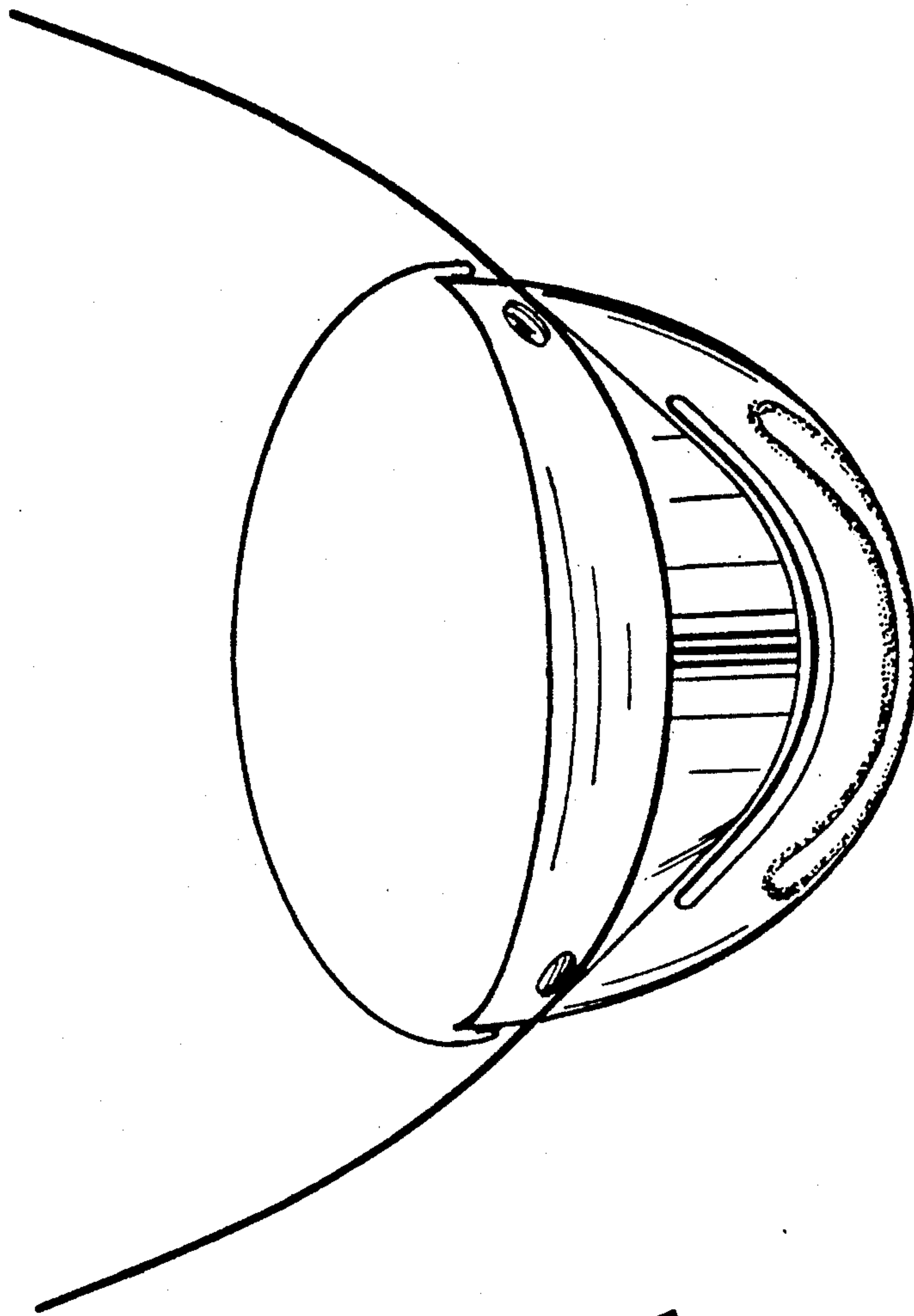

FIG. 3

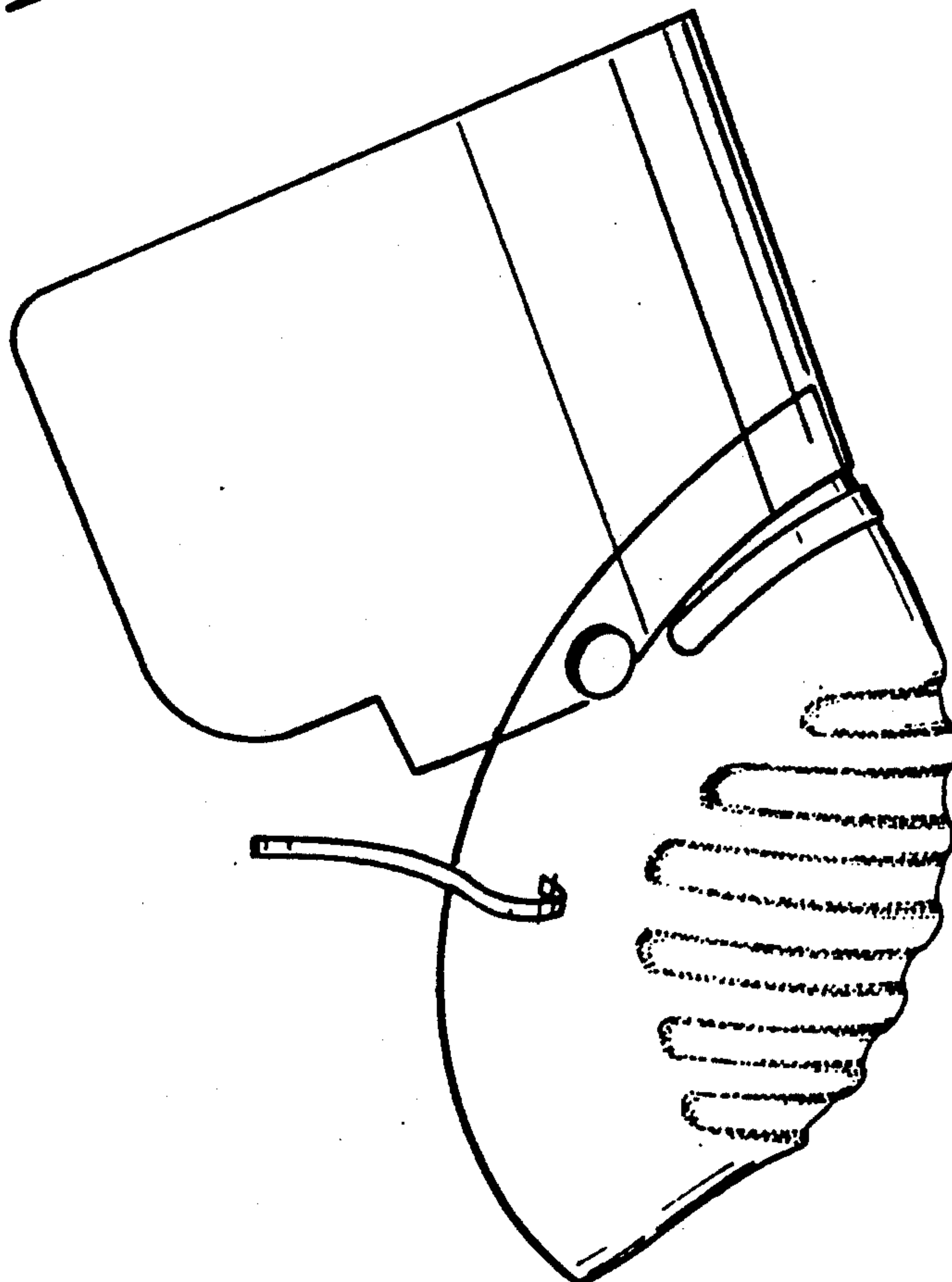

FIG. 4

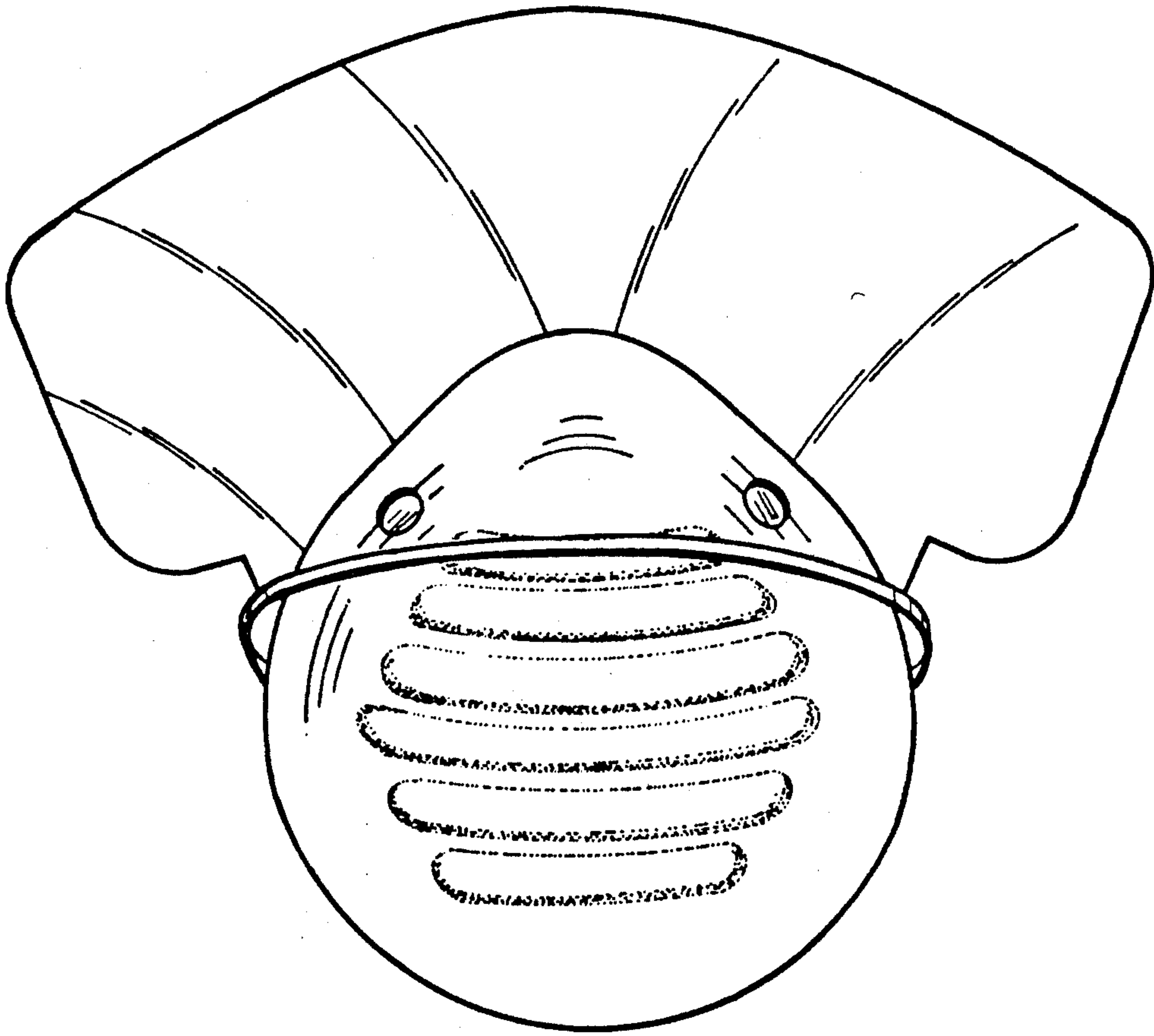

FIG. 5

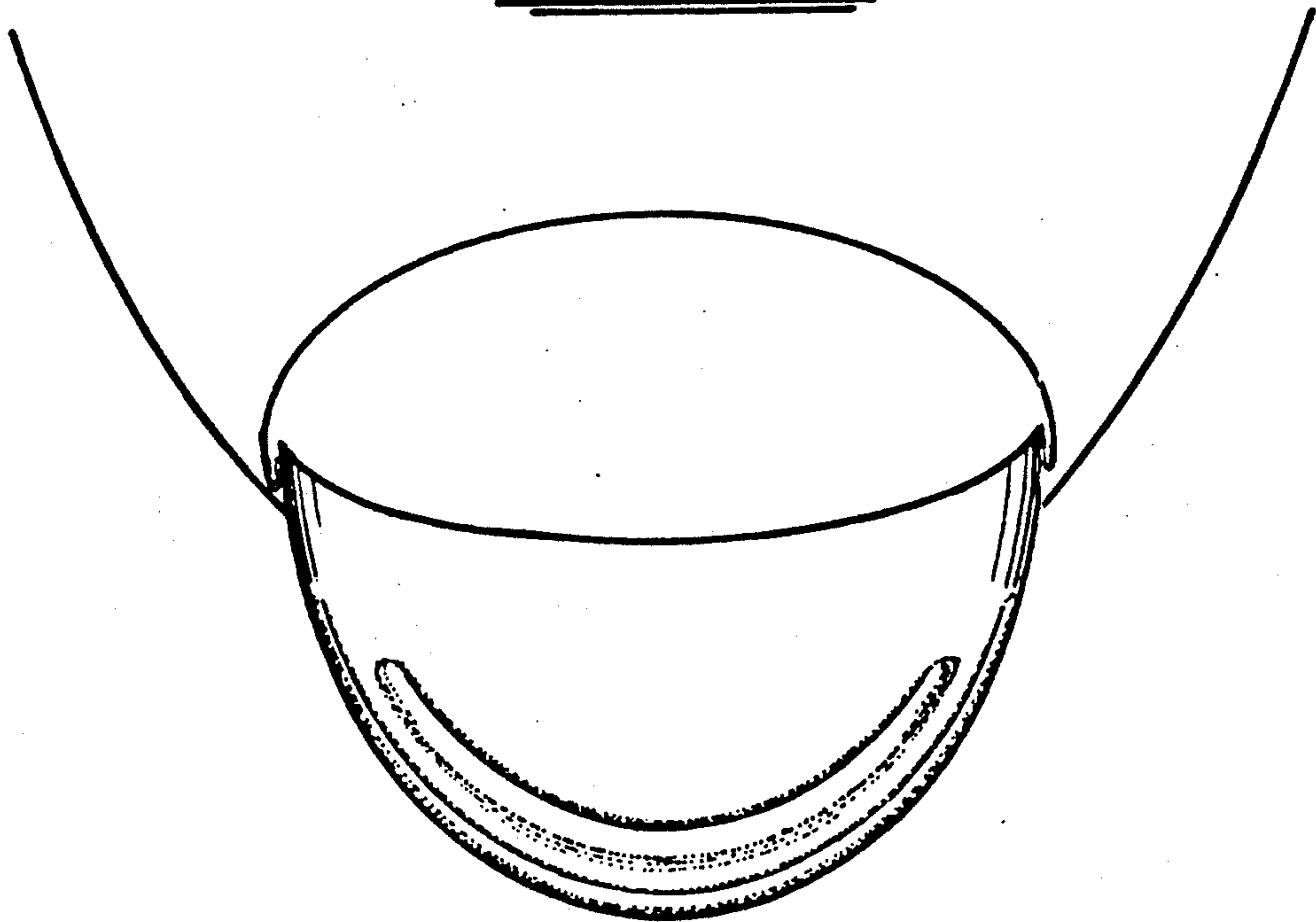

FIG. 6