

[54] JOY STICK

[75] Inventor: Takehiko Ishiwata, Kawasaki, Japan  
[73] Assignee: Nexoft Corporation, Torrance, Calif.  
[\*\*] Term: 14 Years  
[21] Appl. No.: 396,452  
[22] Filed: Aug. 21, 1989  
[52] U.S. Cl. .... D21/48  
[58] Field of Search ..... D21/48, 13; D14/125,  
D14/217, 299; 273/148 B, DIG. 28; D13/158,  
162

[56] References Cited

U.S. PATENT DOCUMENTS

D. 297,953	10/1988	Yasuda et al. ....	D21/48
D. 307,921	5/1990	Barr .....	D21/13
D. 309,455	7/1990	Staley .....	D14/217 X
D. 313,251	12/1990	Hayes .....	D21/48
4,469,330	9/1984	Asher .....	273/148 B
4,870,389	9/1989	Ishiwata et al. ....	273/148 B X

OTHER PUBLICATIONS

Playthings, Sep. 1988, p. 49, top right of the page.  
Playthings, Sep. 1988, p. 50, top right of the page.

Primary Examiner—Bernard Ansher  
Assistant Examiner—Prabhakar Deshmukh  
Attorney, Agent, or Firm—Koda and Androlia

[57] CLAIM

The ornamental design for the joy stick, as shown and described.

DESCRIPTION

FIG. 1 is a front, top and right side perspective view of the joy stick showing my new design;  
FIG. 2 is a top plan view thereof;  
FIG. 3 is a bottom plan view thereof;  
FIG. 4 is a front elevational view thereof;  
FIG. 5 is a rear elevational view thereof;  
FIG. 6 is a left side elevational view thereof; and  
FIG. 7 is a right side elevational view thereof.

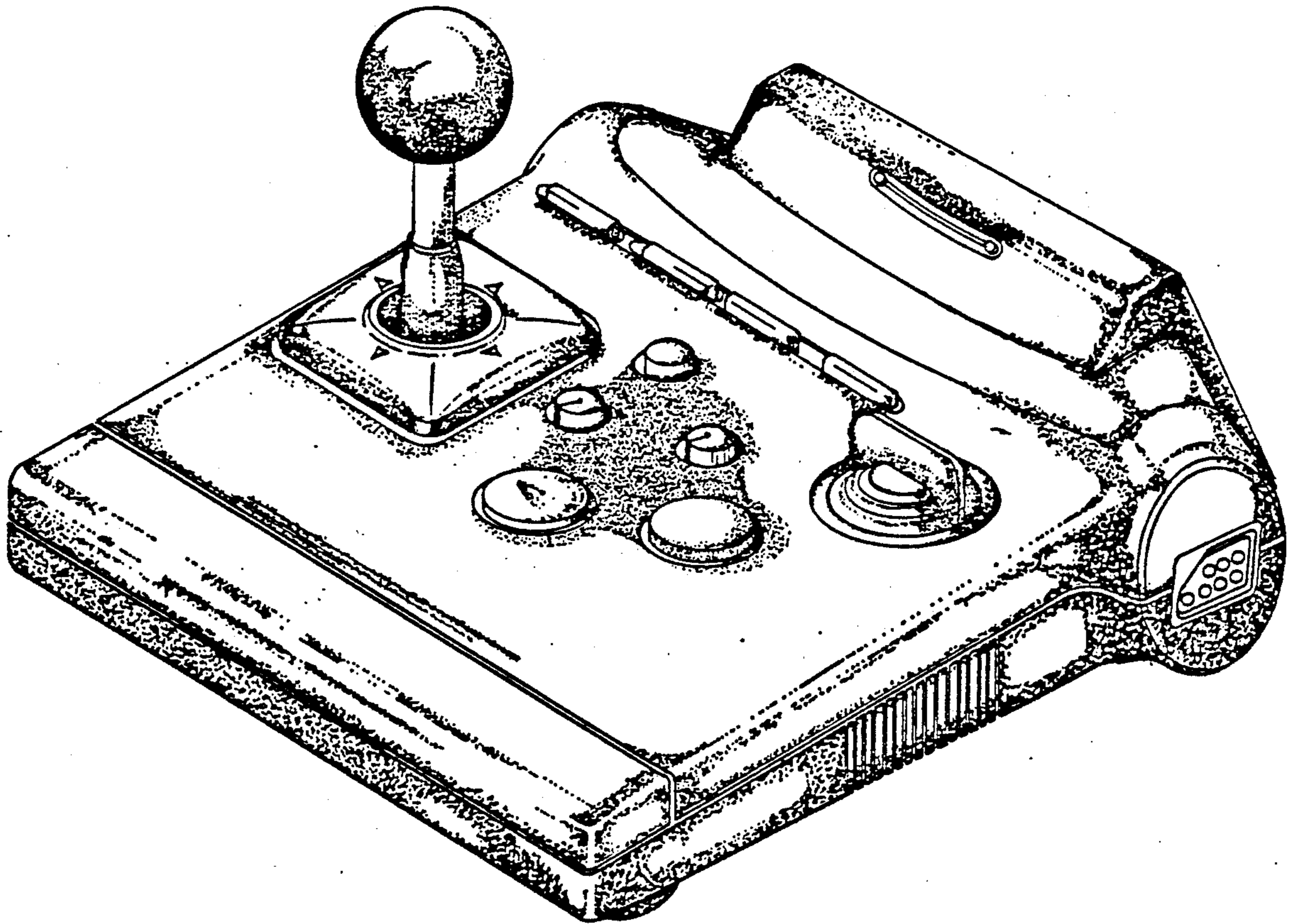

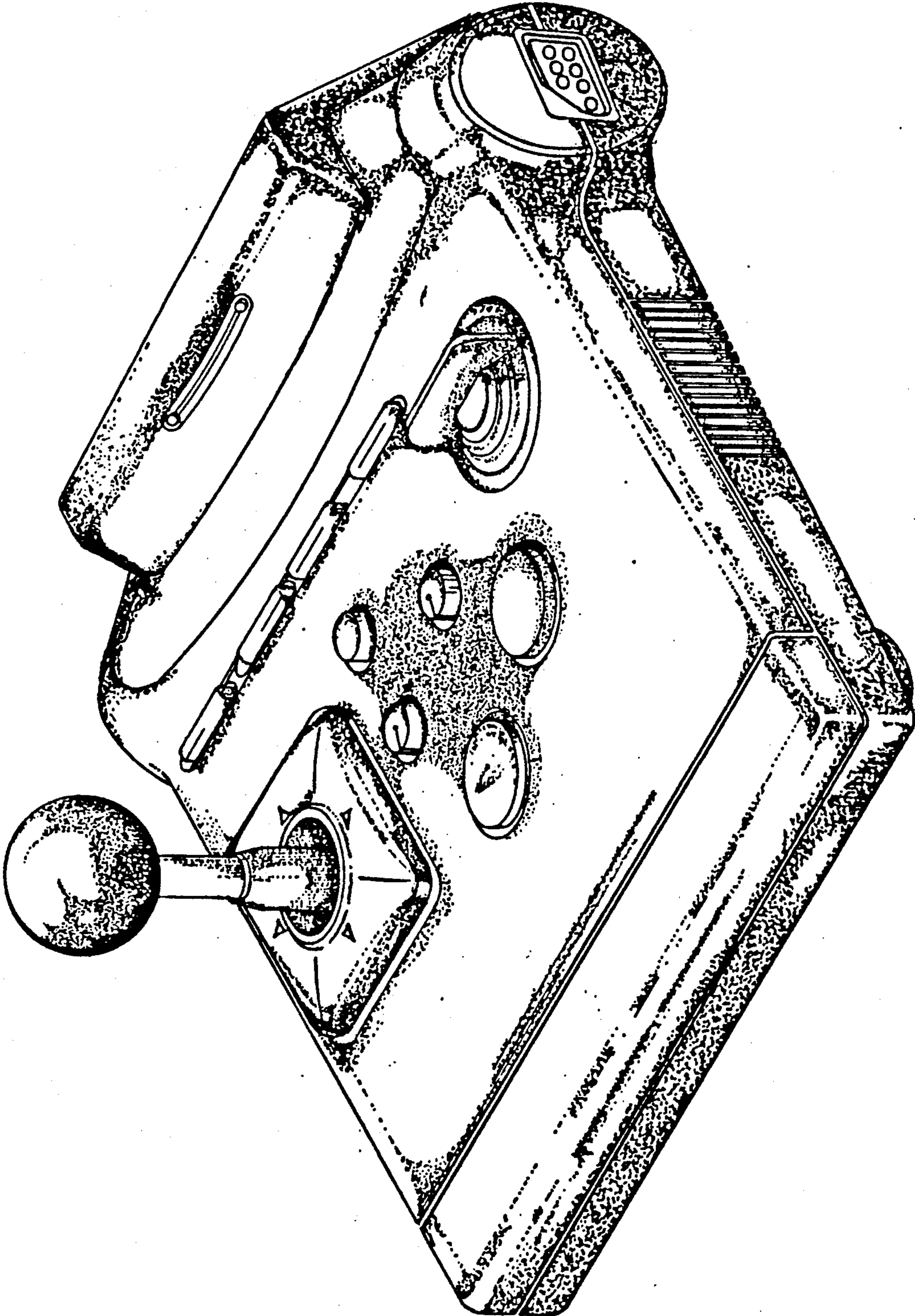

FIG. 1

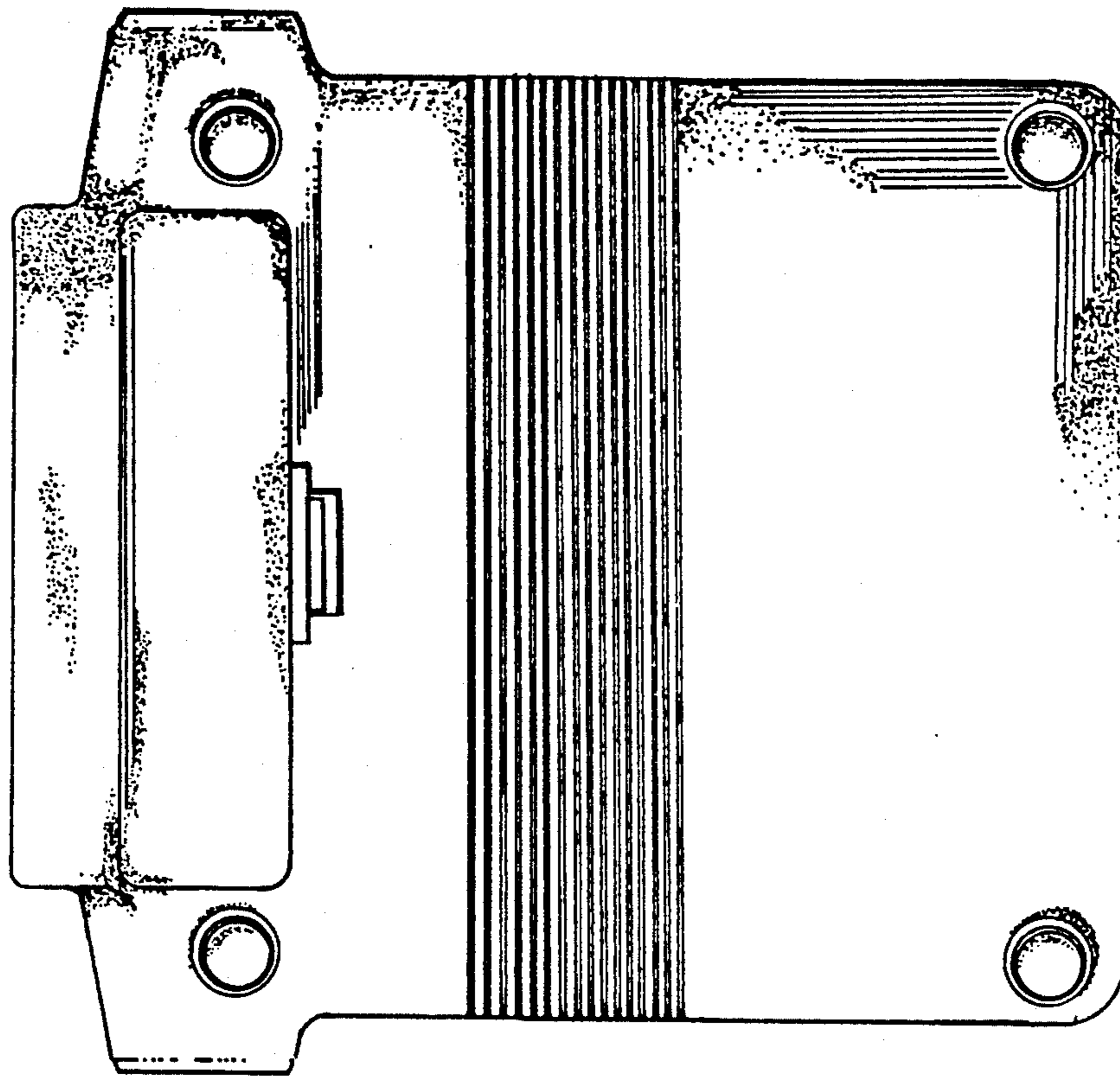

FIG. 2

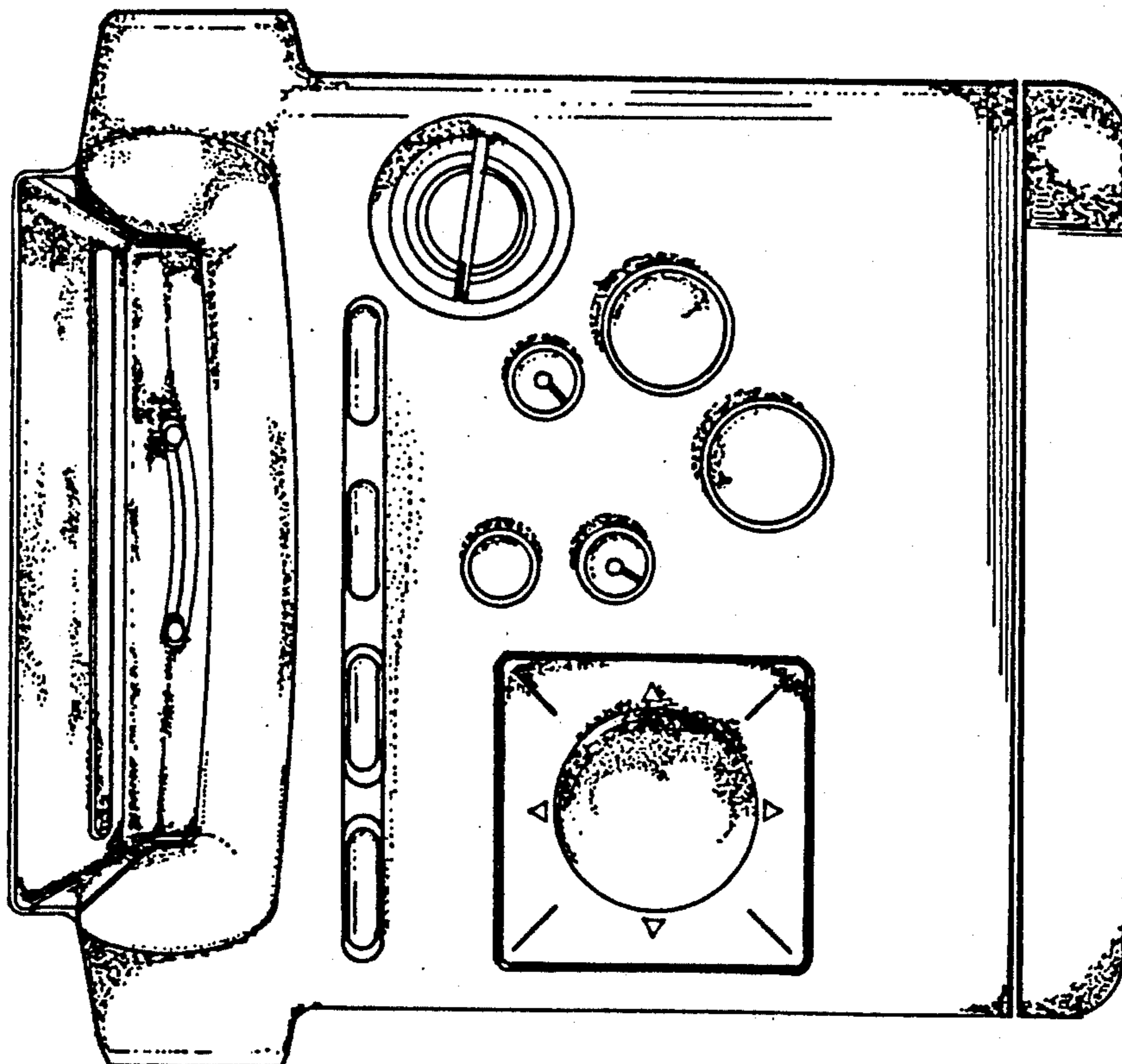

FIG. 3

FIG. 5

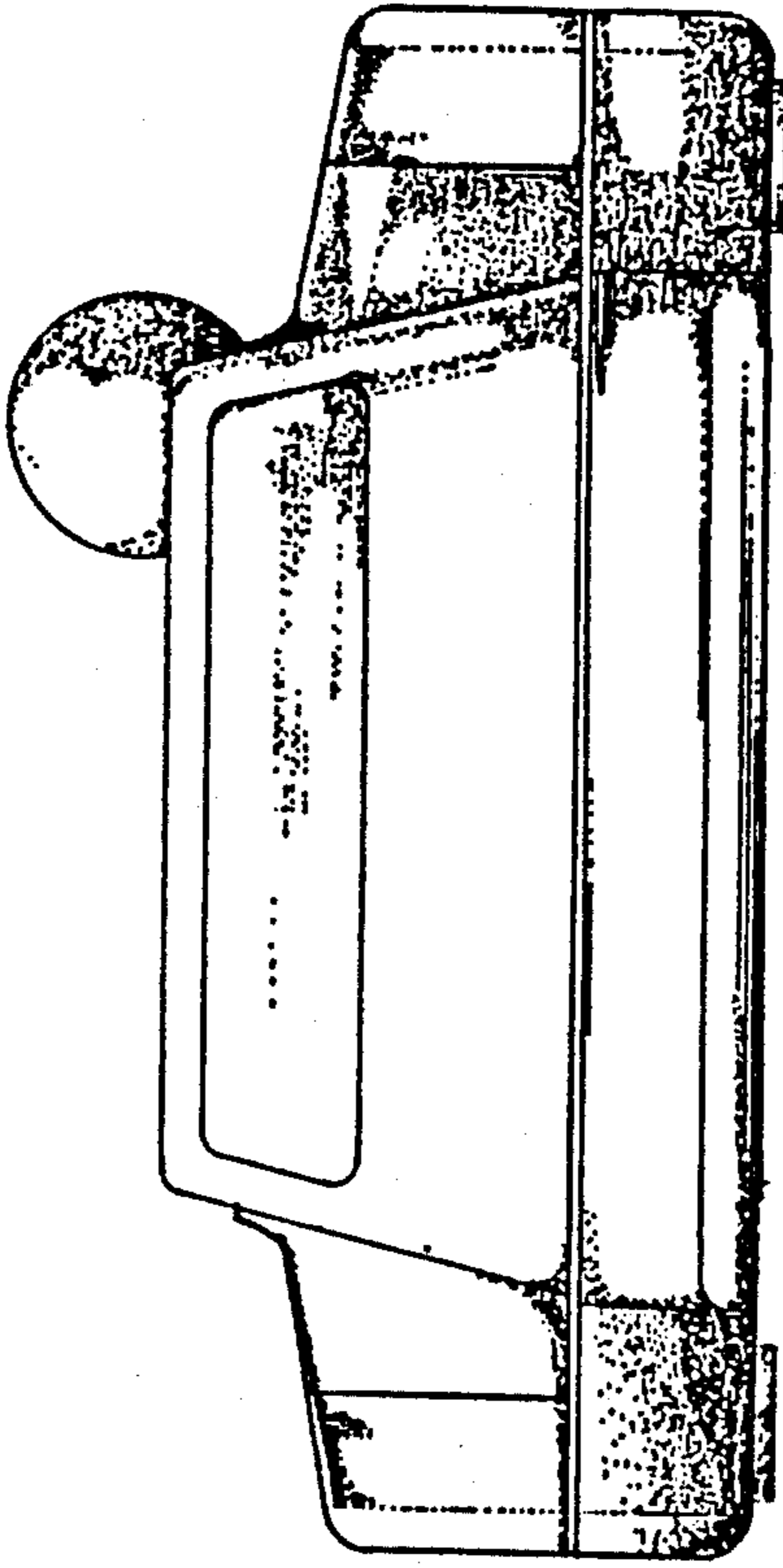

FIG. 4

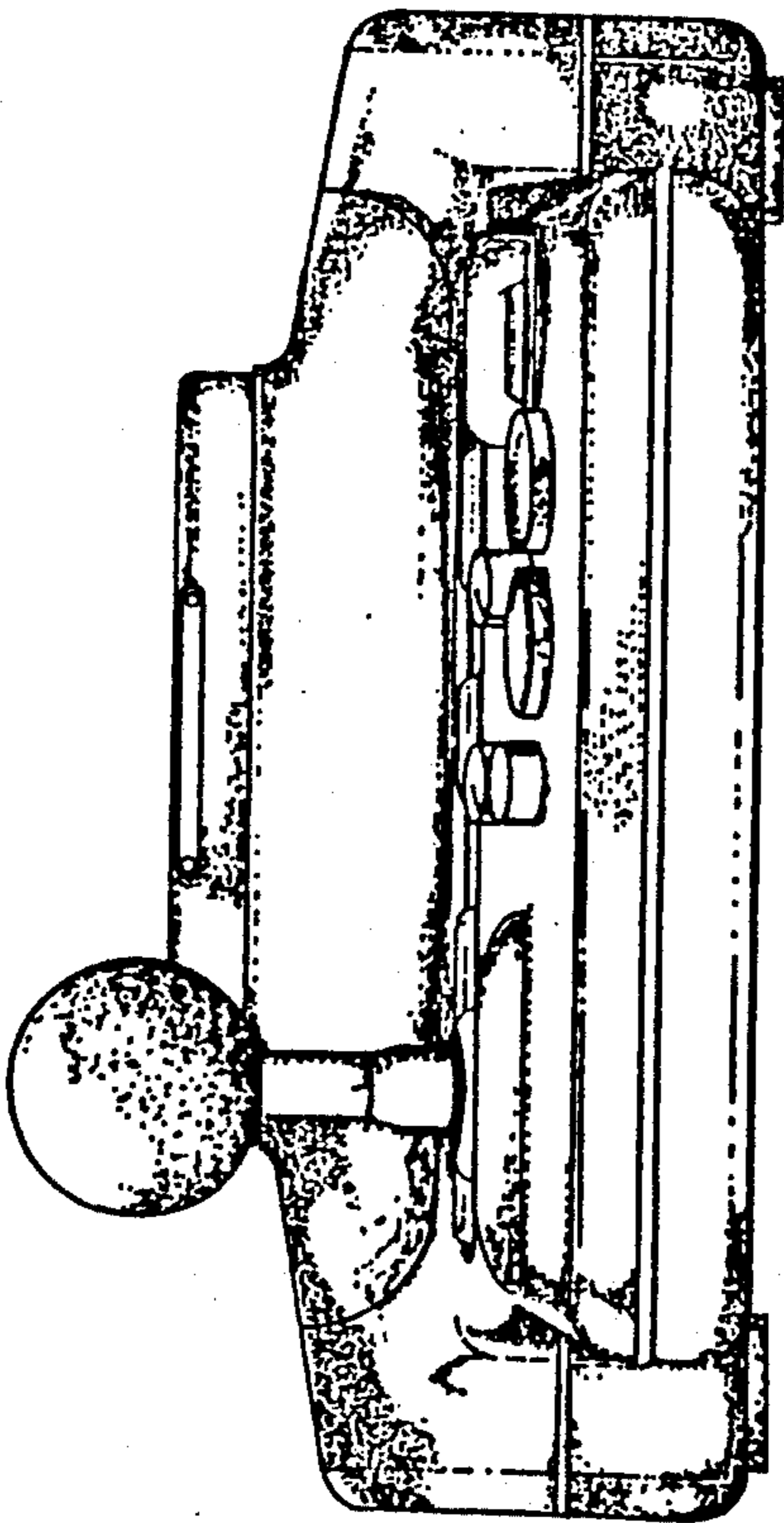

FIG. 7

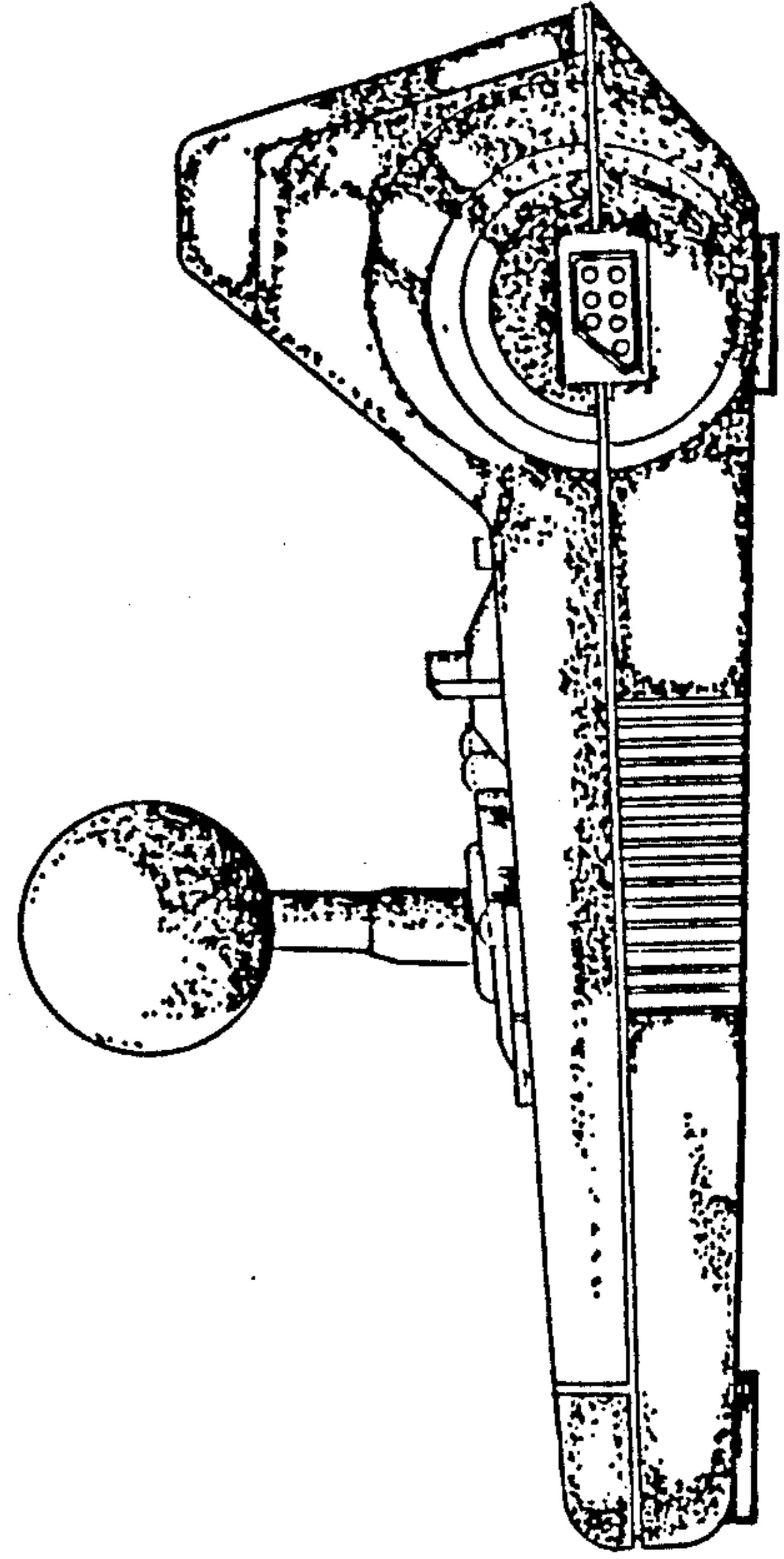

FIG. 6

