

[54] **LOADING MODULE FOR CURRENCY CARTRIDGES**

[75] Inventors: **Stephan Feger, Stuttgart; Wolfgang Fischer, Boeblingen; Wolfgang Guber, Ludwigsburg, all of Fed. Rep. of Germany**

[73] Assignee: **International Business Machines Corporation, Armonk, N.Y.**

[**] Term: **14 Years**

[21] Appl. No.: **168,342**

[22] Filed: **Mar. 14, 1988**

[30] **Foreign Application Priority Data**

Oct. 14, 1987 [DE] Fed. Rep. of Germany MR 6330

[52] U.S. Cl. **D14/105; D14/110; D18/3**

[58] Field of Search **D14/100, 102, 110, 114, D14/107; D18/4; D13/147, 162, 199; D20/1; D99/28; 360/97-99, 132, 133; 273/148 B, 1 GC; 361/392, 394, 395, 399, 413, 415; 174/52 R; 235/375, 376, 378-382, 382.5, 385, 425, 437, 438; 209/509, 534, 546, 610; 194/229, 230, 234, 232, 237, 210, 205, 206, 302**

[56] **References Cited**

U.S. PATENT DOCUMENTS

- 3,283,897 11/1966 Haville 209/534
- 3,462,225 8/1969 Bayha 194/206 X
- 3,618,765 11/1971 Cooper et al. 209/534
- 3,768,616 10/1973 Dykehouse et al. 194/206

- 3,906,201 9/1975 Housman et al. 235/380
- 4,369,360 1/1983 Tsuji 235/379
- 4,398,088 8/1983 Hirose et al. 209/534 X
- 4,500,002 2/1985 Koshio et al. 209/534

OTHER PUBLICATIONS

IBM Brochure, Mar. 1986, p. 4, The IBM 4736 Automatic Teller Machine.

Siemens Brochure, p. 7, Geldautomat GAT 9777.

Primary Examiner—Wallace R. Burke

Assistant Examiner—Freda S. Nunn

Attorney, Agent, or Firm—Karl O. Hesse

[57] **CLAIM**

The ornamental design for a loading module for currency cartridges, as shown and described.

DESCRIPTION

FIG. 1 is a perspective view of a loading module for currency cartridges showing our new design;

FIG. 2 is a front elevational view thereof on an enlarged scale;

FIG. 3 is a rear elevational view thereof on an enlarged scale;

FIG. 4 is a left side elevational view thereof on an enlarged scale;

FIG. 5 is a right side elevational view thereof on an enlarged scale;

FIG. 6 is a top plan view thereof on an enlarged scale;

FIG. 7 is a bottom plan view thereof on an enlarged scale.

The key shown in broken lines in FIGS. 1, 2, 3, 5, 6, and 7 is shown for illustrative purposes only and forms no part of the claimed design.

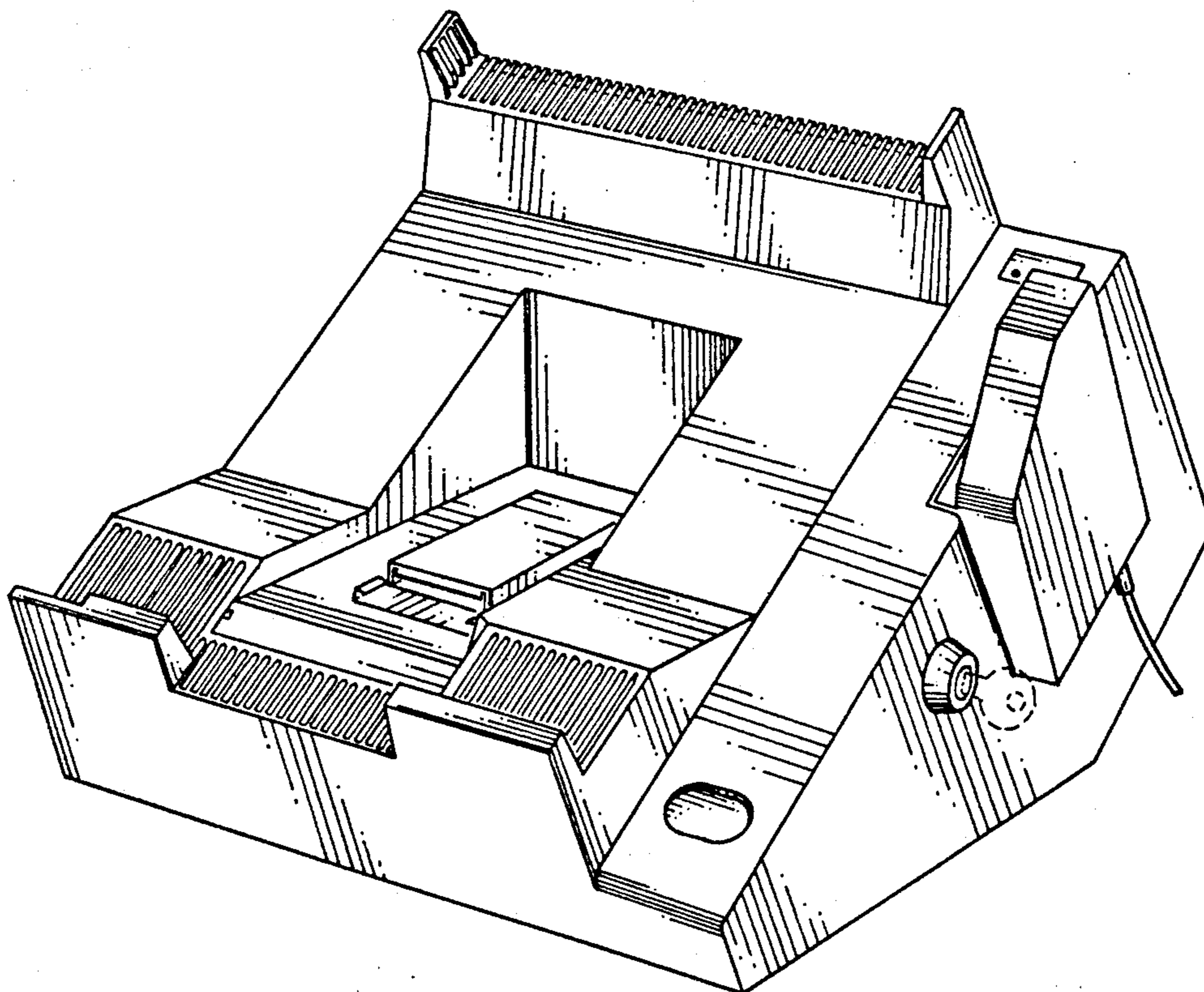

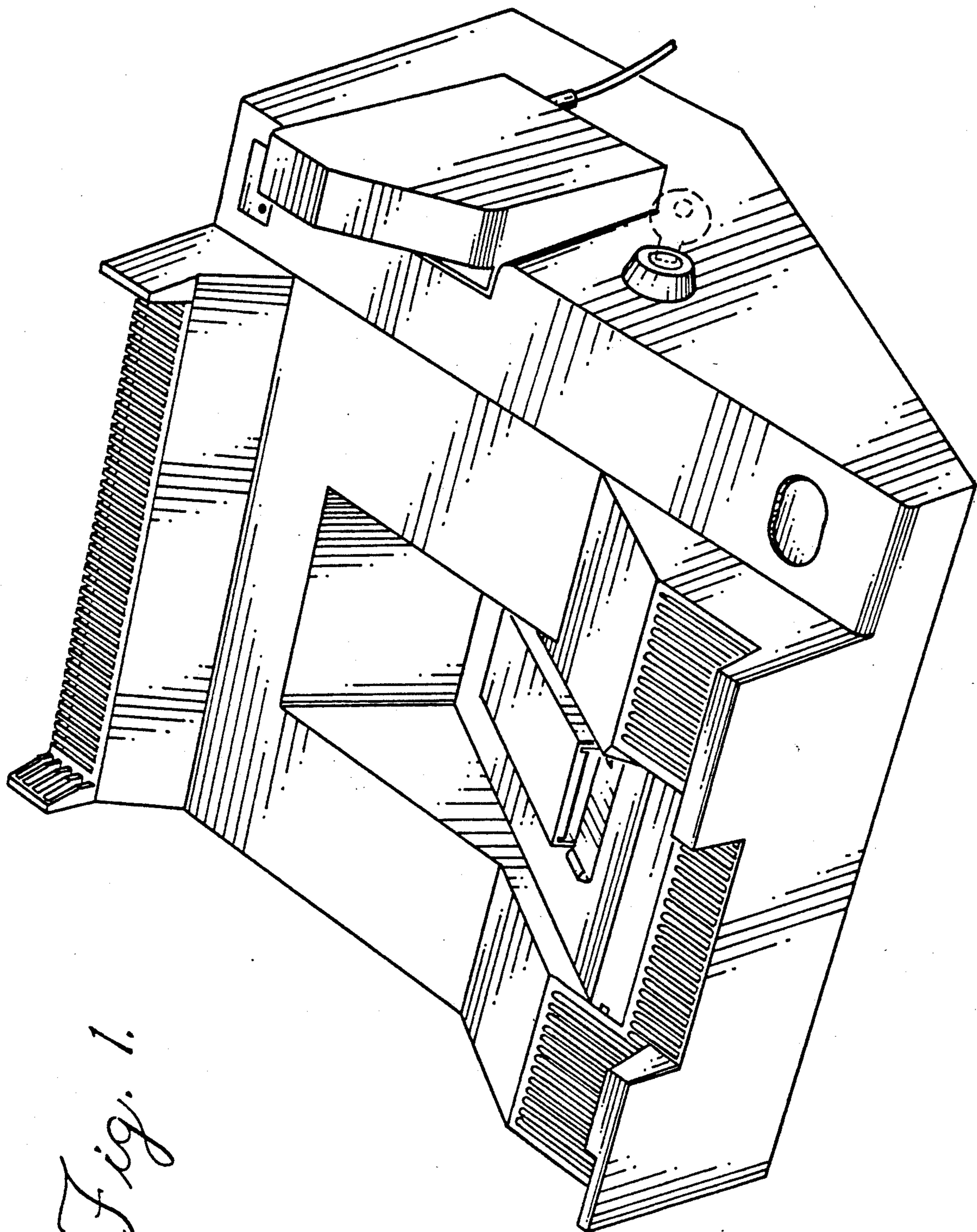
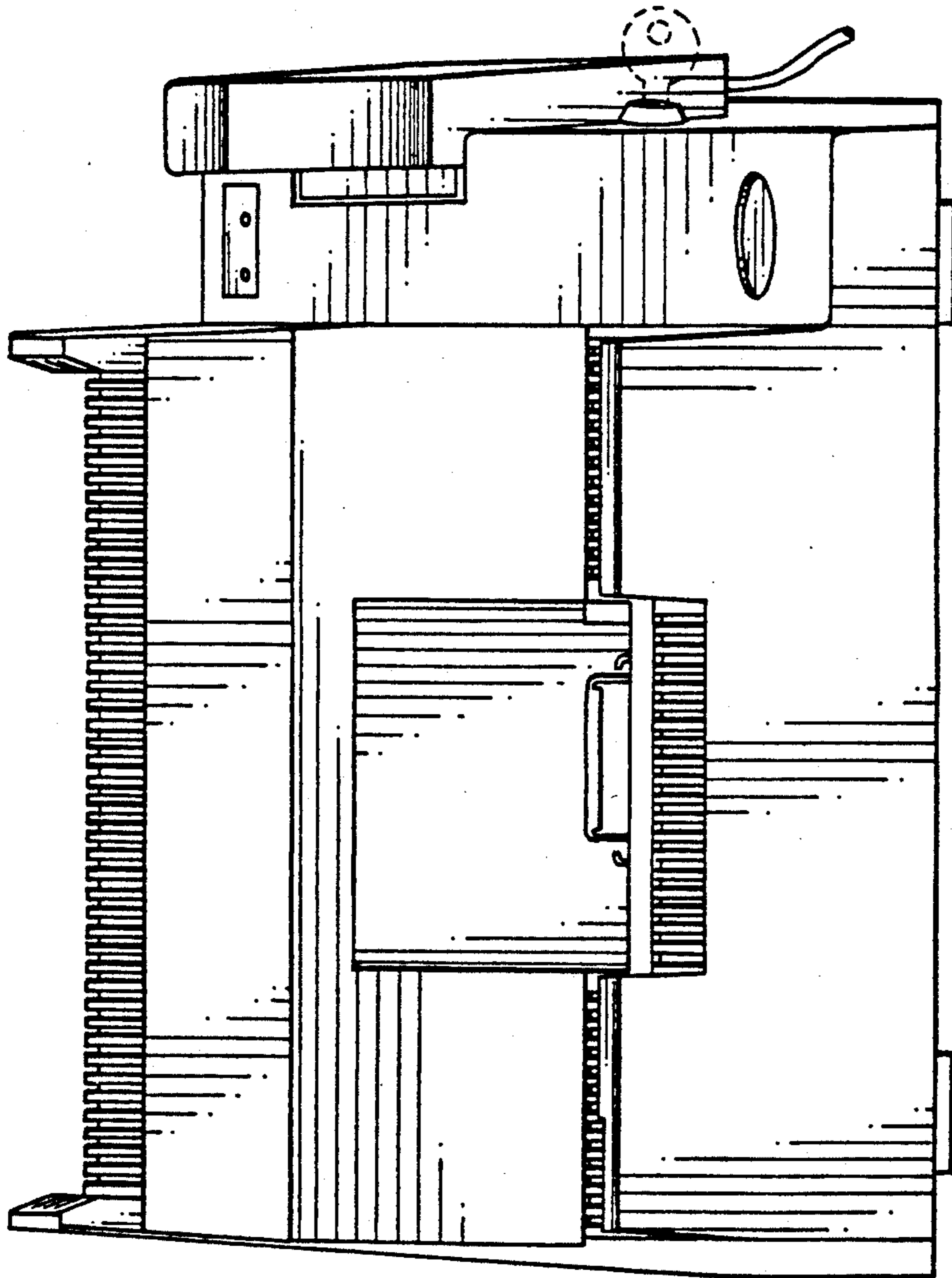

Fig. 1.

Fig. 2.



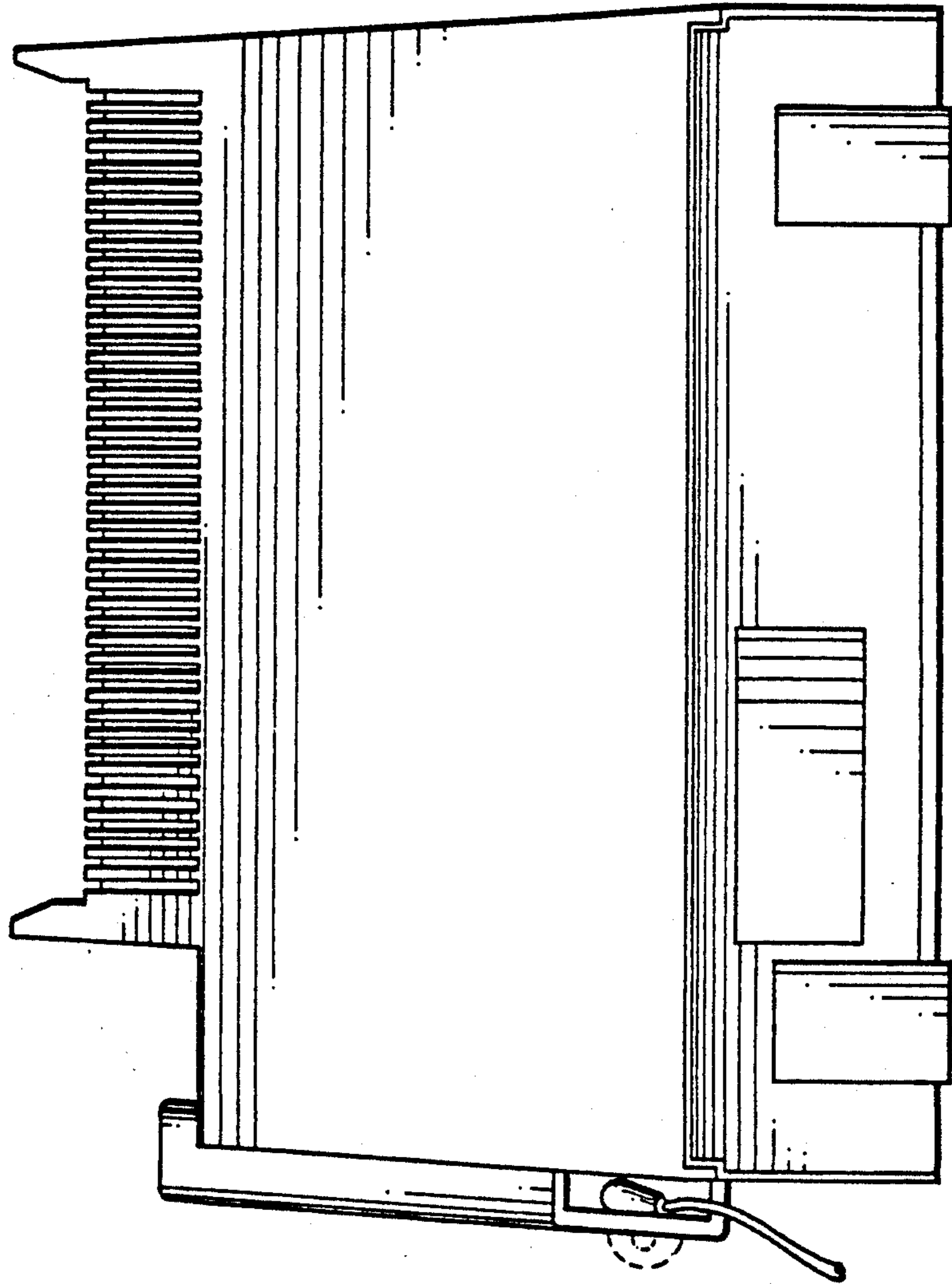
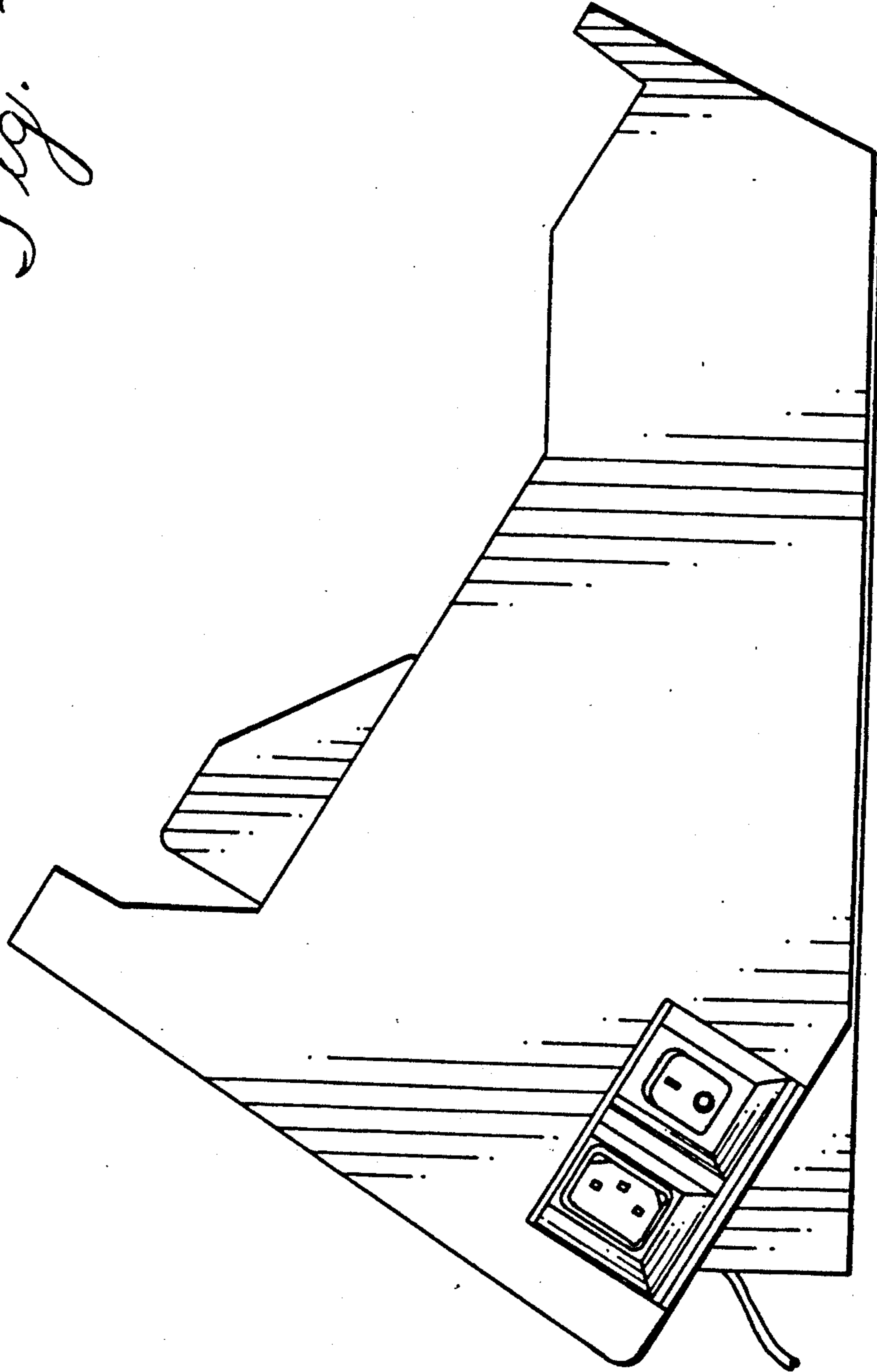

Fig. 3.

Fig. 4.



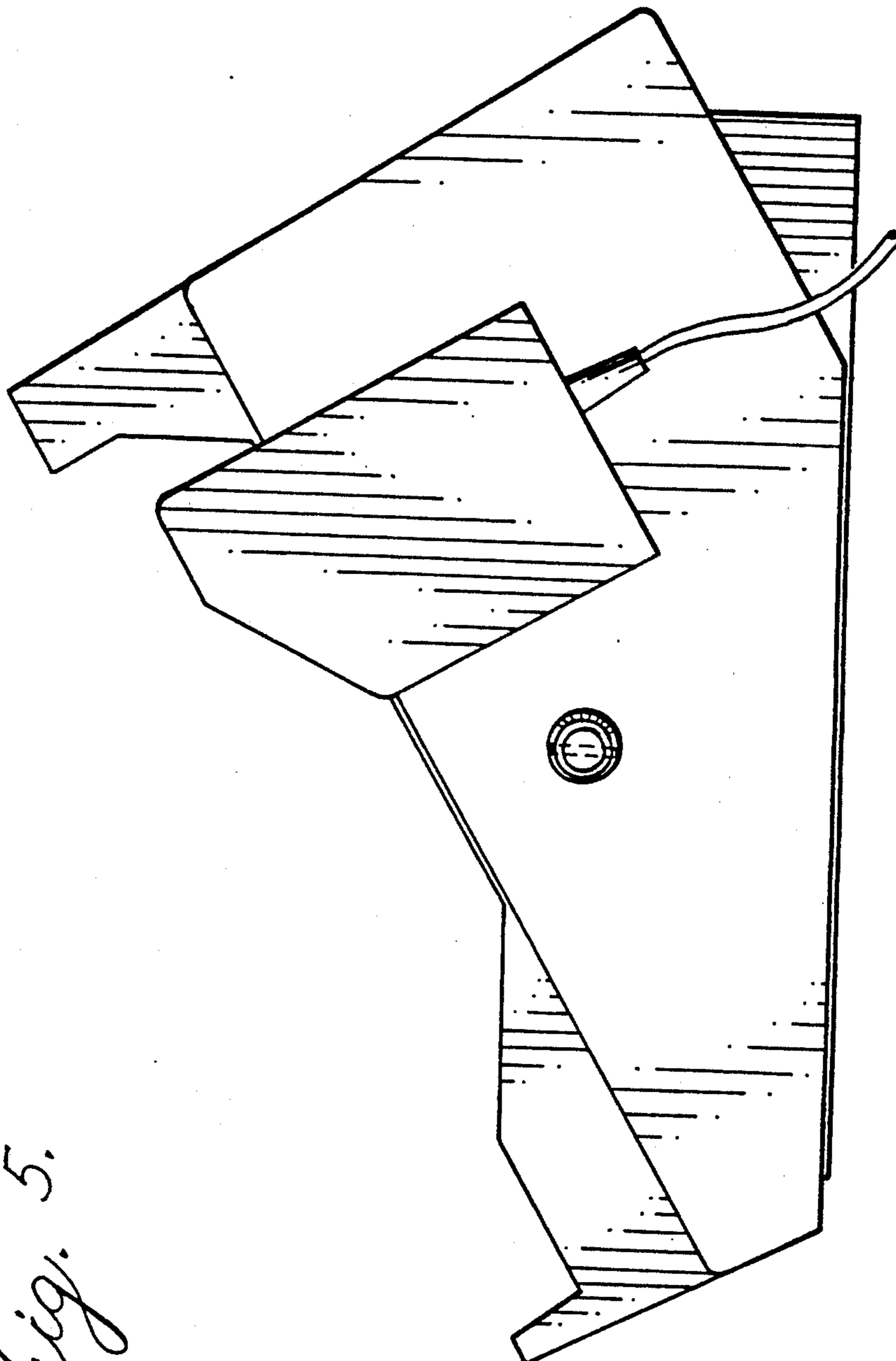
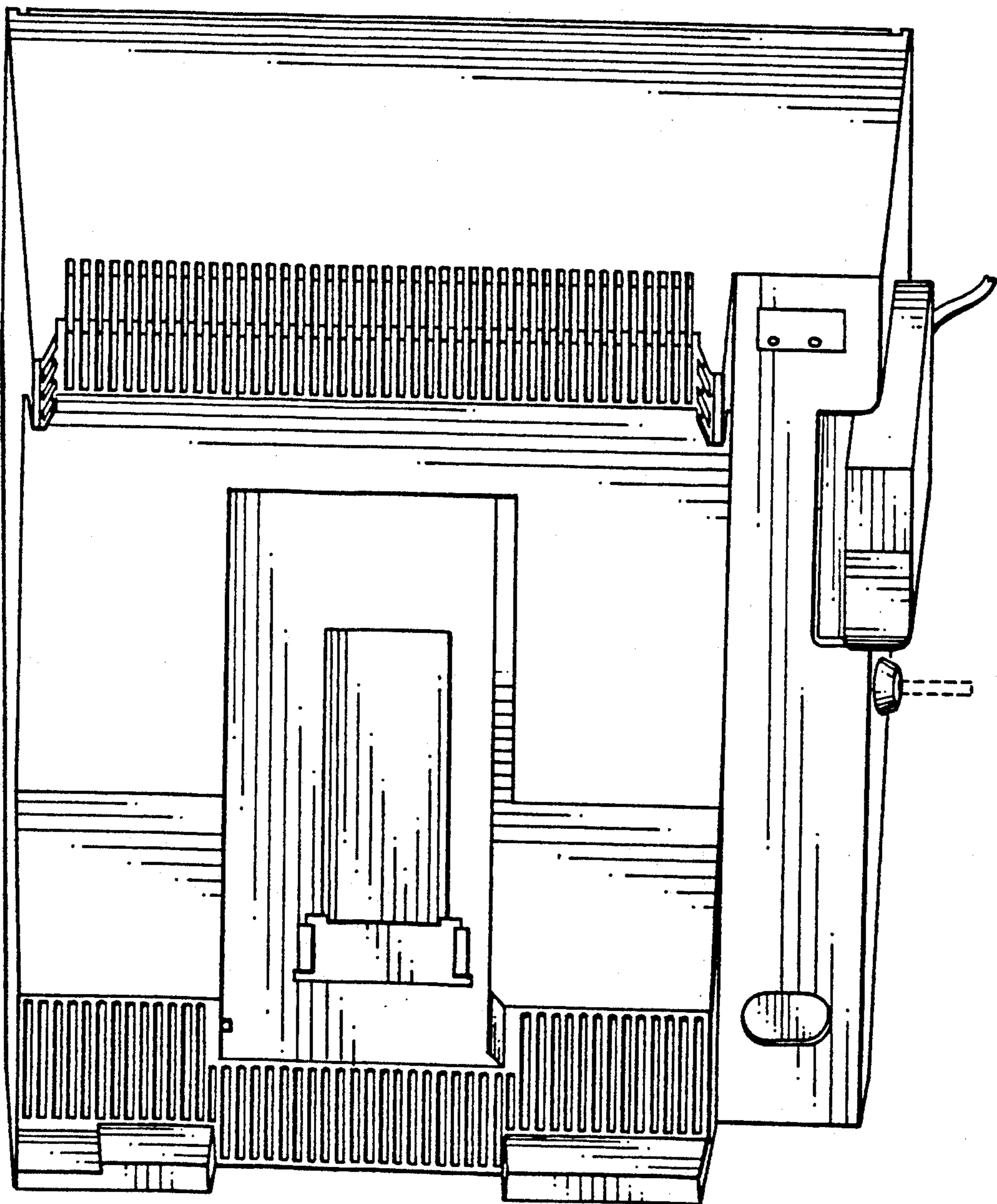

Fig. 5.

Fig. 6.



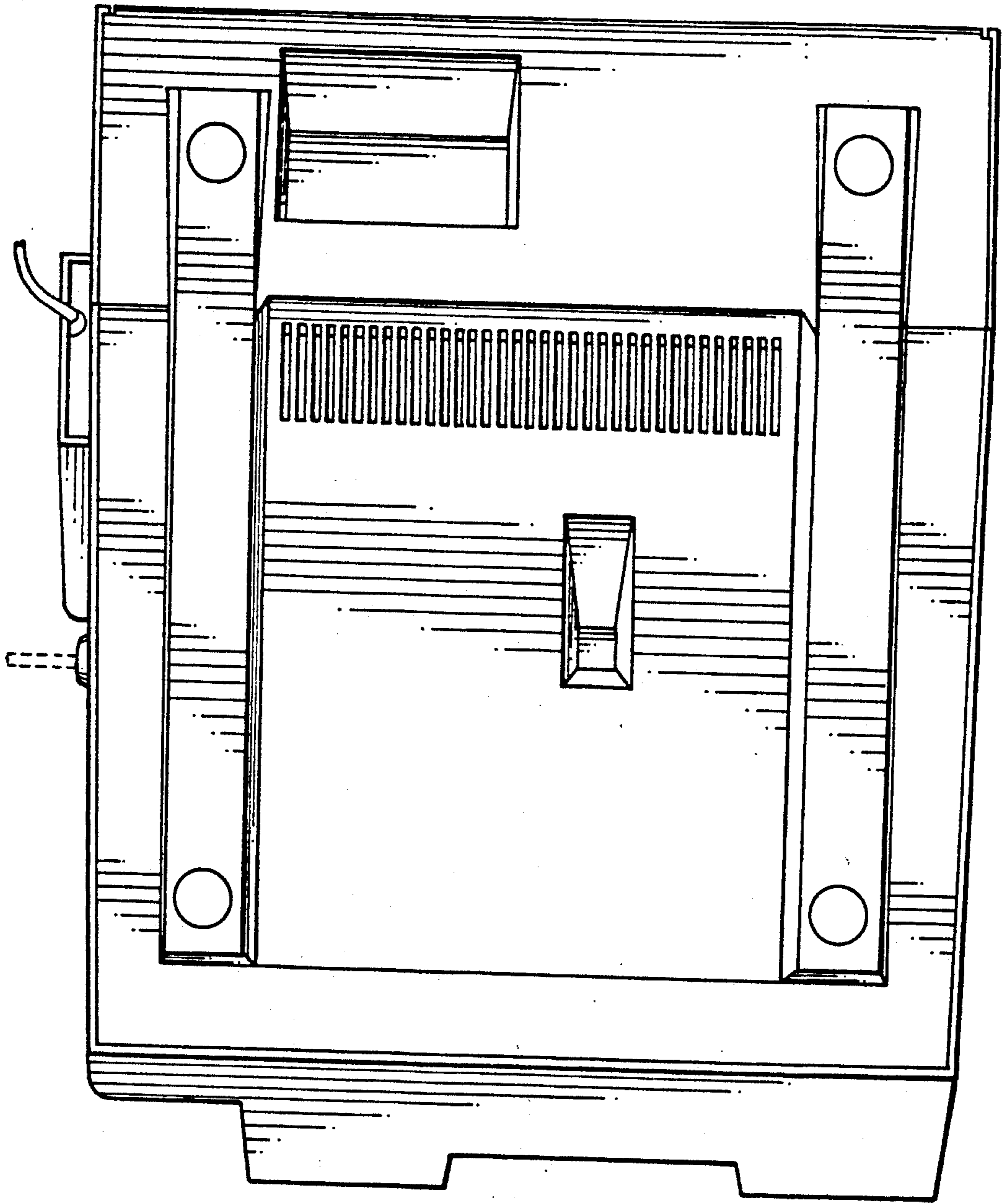

Fig. 7.