

[54] WOODWIND MOUTHPIECE

[76] Inventor: William P. Disera, 555 Westminster St., Joliet, Ill. 60435

[**] Term: 14 Years

[21] Appl. No.: 478,768

[22] Filed: Feb. 12, 1990

FOREIGN PATENT DOCUMENTS

066134 12/1947 Denmark 84/383

OTHER PUBLICATIONS

Grossman Music Corp. Catalog, 1968 p. 144 (Brilhart Mouthpieces at upper left).

Primary Examiner—Bernard Ansher
Assistant Examiner—Adir Aronovich
Attorney, Agent, or Firm—Willian Brinks Olds Hofer Gilson & Lione

Related U.S. Application Data

- [62] Division of Ser. No. 38,343, Apr. 14, 1987.
- [52] U.S. Cl. D17/13; D15/29
- [58] Field of Search D17/13; D15/29; 84/383

[57] CLAIM

The ornamental design for a woodwind mouthpiece, as shown and described.

[56] References Cited

U.S. PATENT DOCUMENTS

D. 139,025	10/1944	Runyon, Jr.	D17/13
D. 243,843	3/1977	Edwards	D15/29
915,809	3/1909	Thomas	D15/29
2,525,523	10/1950	Chance	84/383
3,094,891	6/1963	Brilhart	84/383
4,041,827	8/1977	Daglis	84/383
4,345,503	8/1982	Runyon	84/383

DESCRIPTION

FIG. 1 is a bottom front perspective view of a woodwind mouthpiece showing my new design; FIG. 2 is a top plan view thereof; FIG. 3 is a front elevational view thereof; FIG. 4 is a side elevational view thereof; FIG. 5 is a rear elevational view thereof; FIG. 6 is a bottom plan view thereof; and FIG. 7 is a cross-sectional view taken along line 7—7 of FIG. 2.

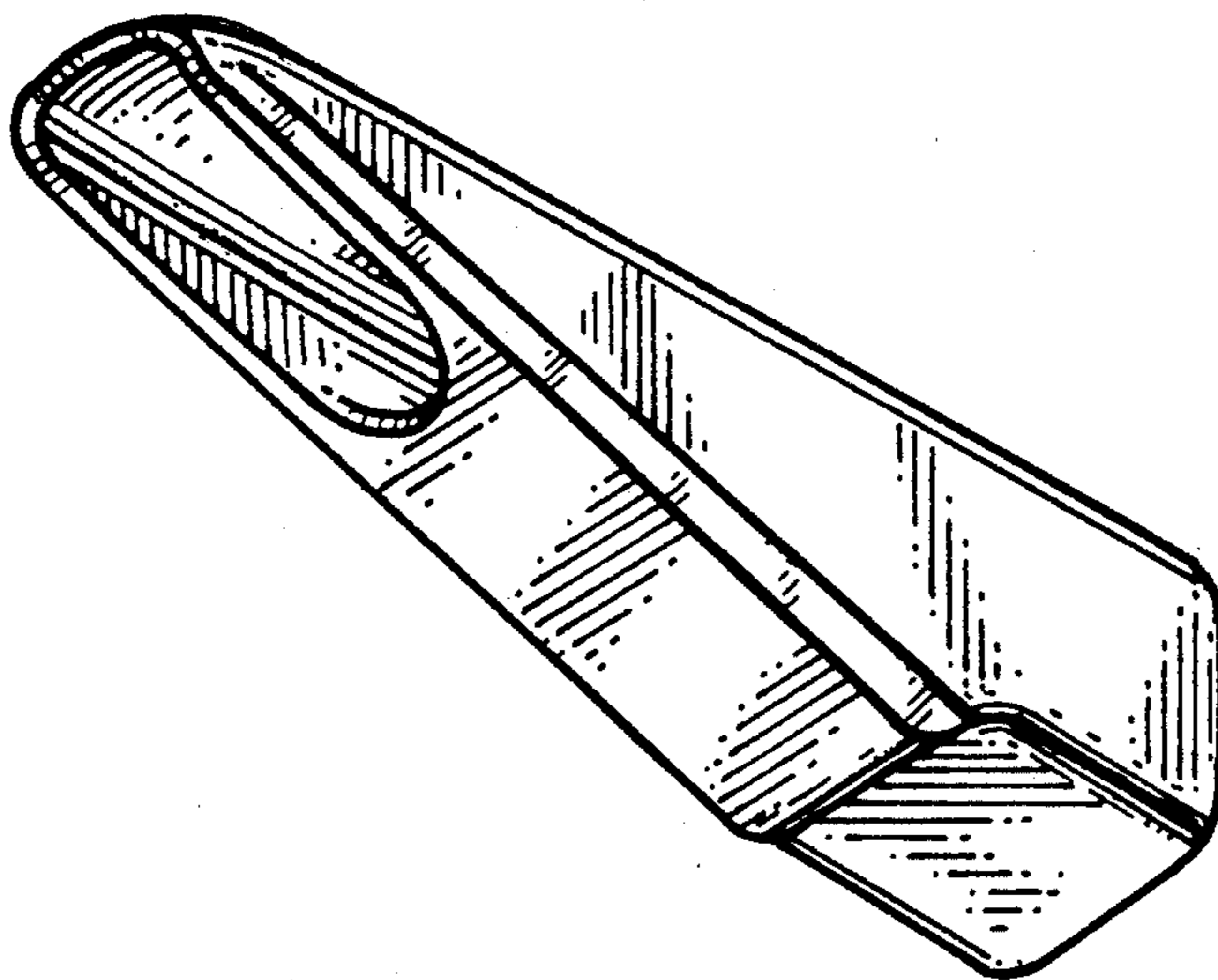

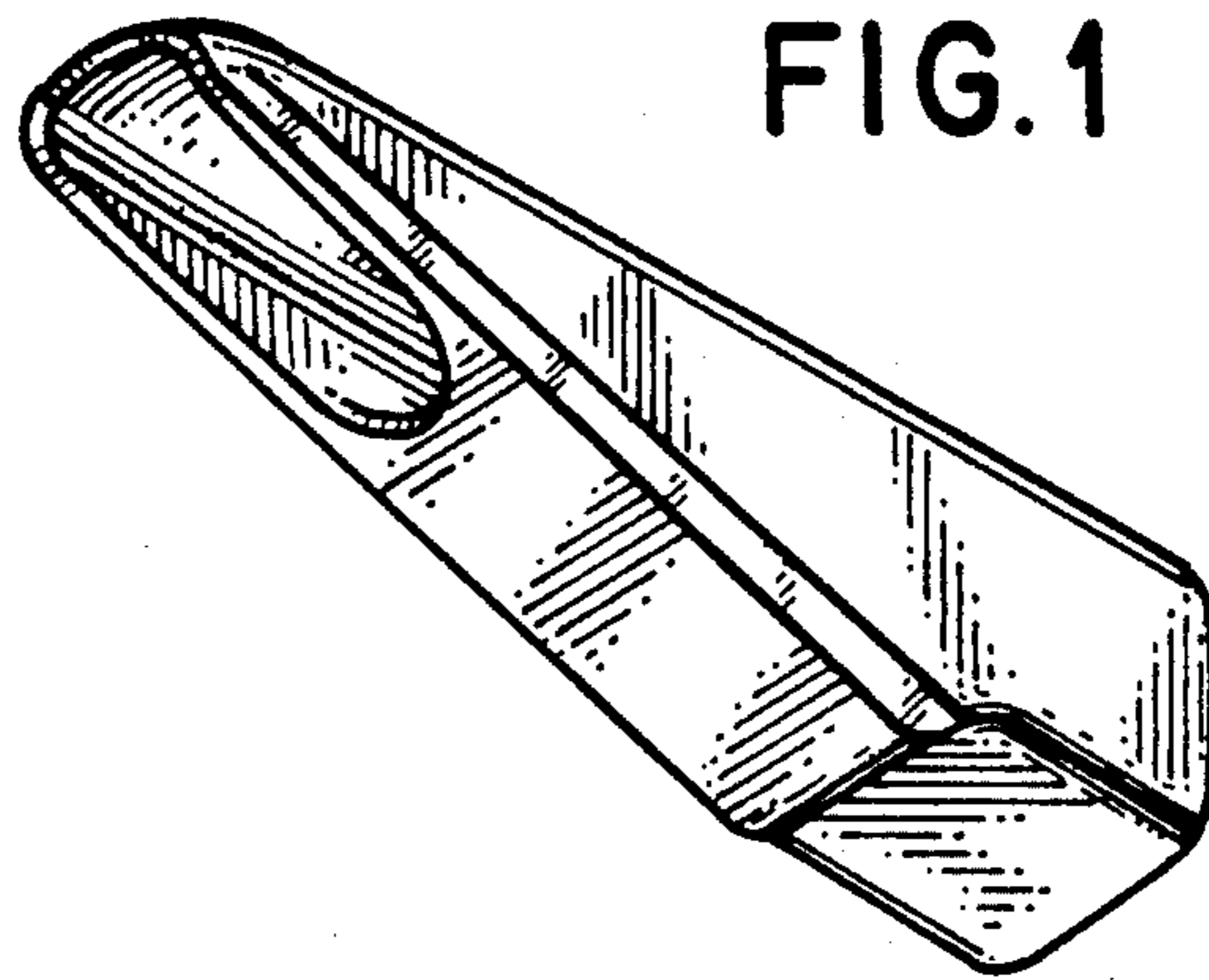

FIG. 1

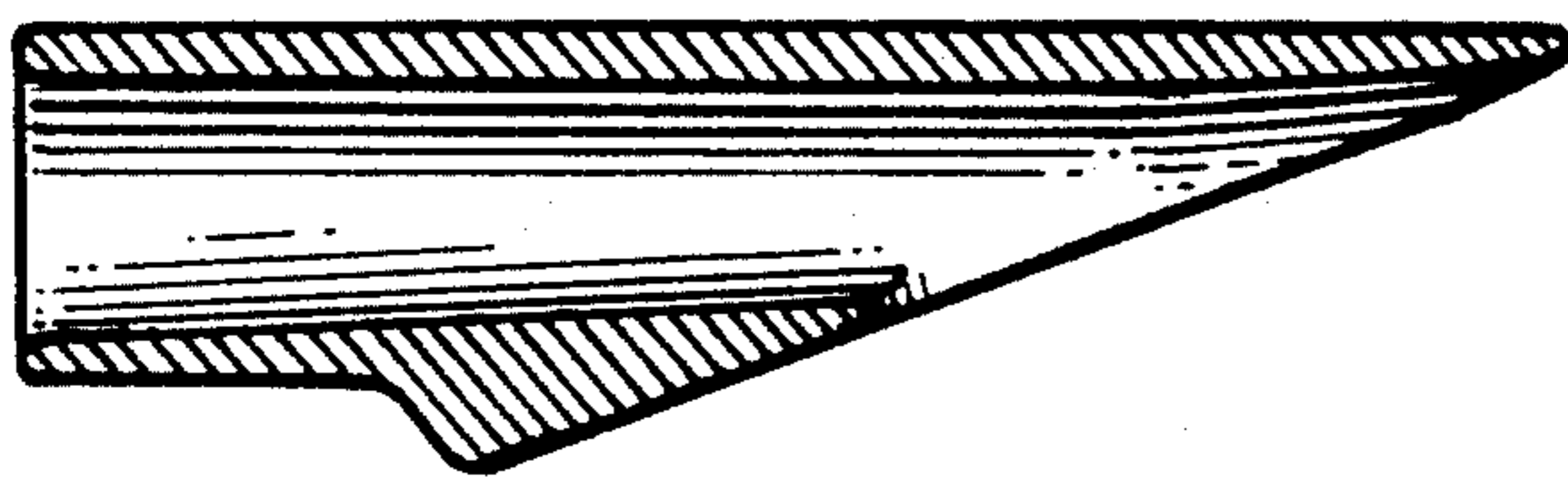

FIG. 7

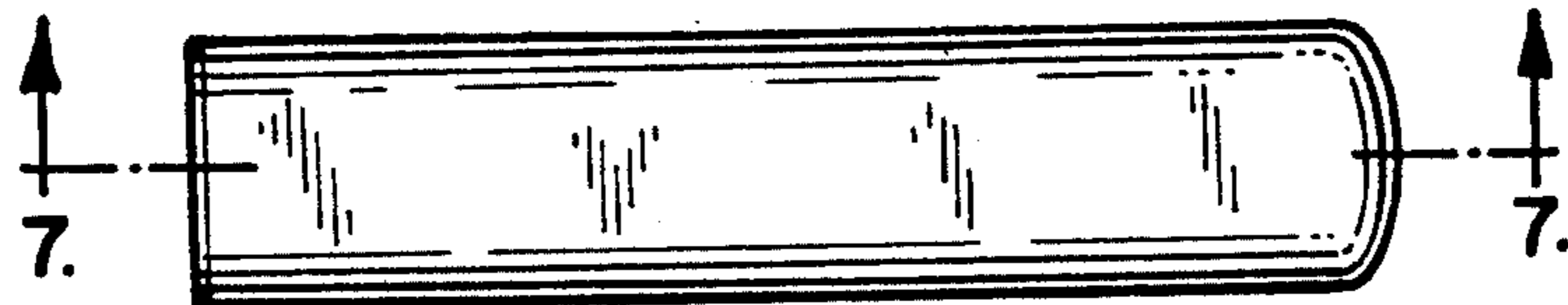

FIG. 2

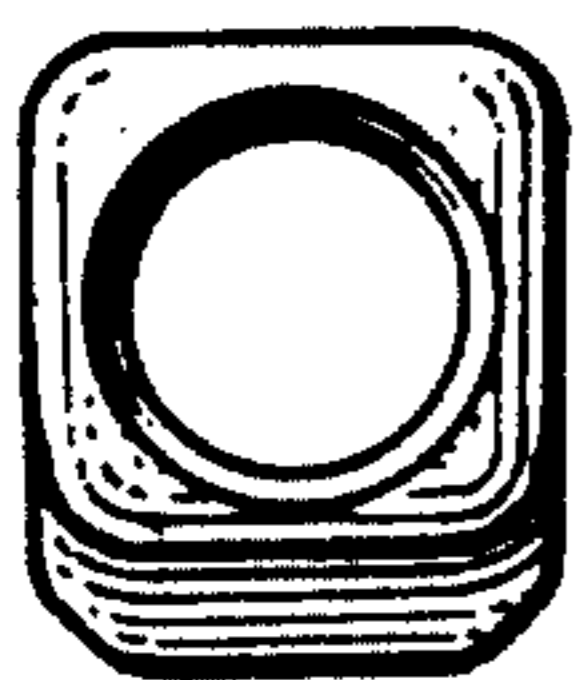

FIG. 3

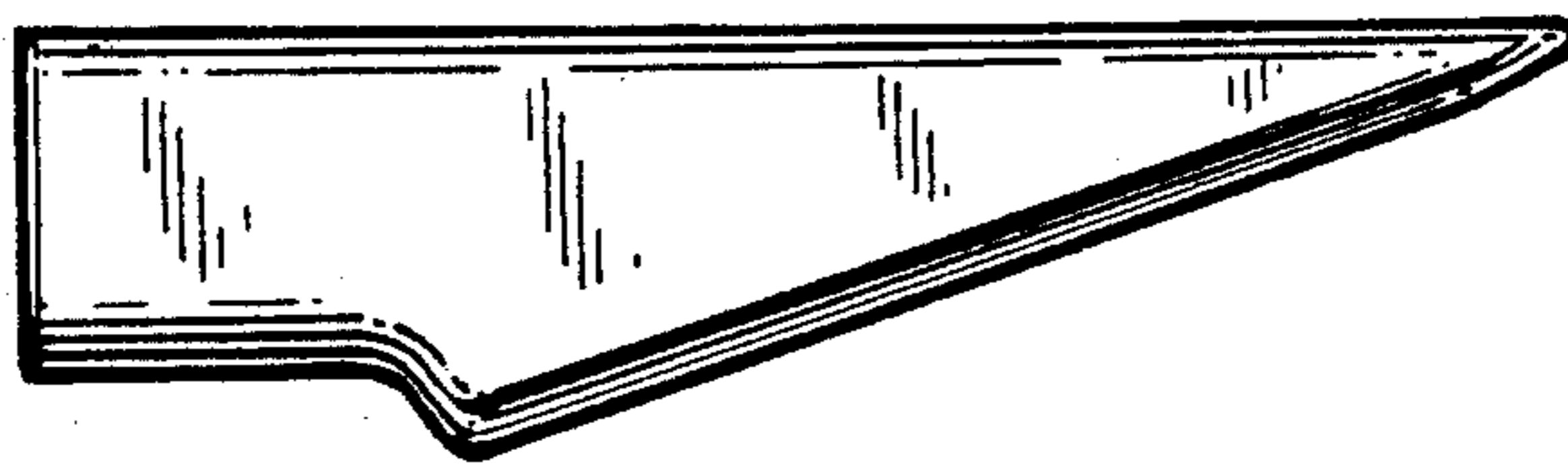

FIG. 4

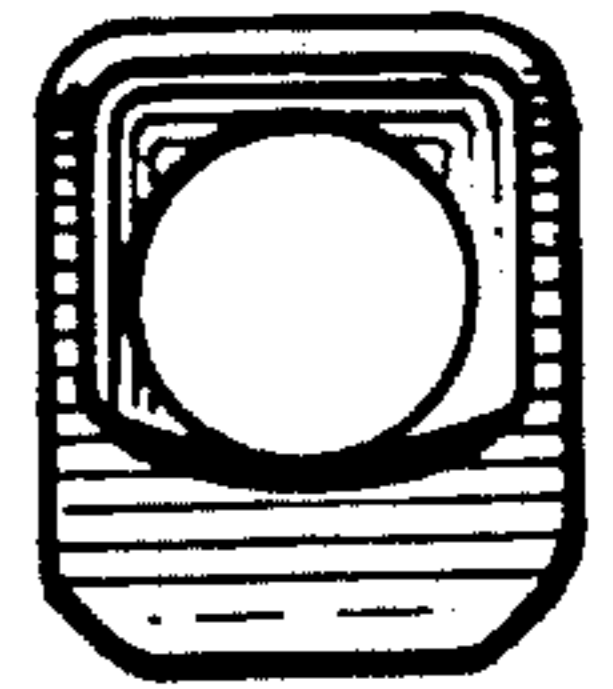

FIG. 5

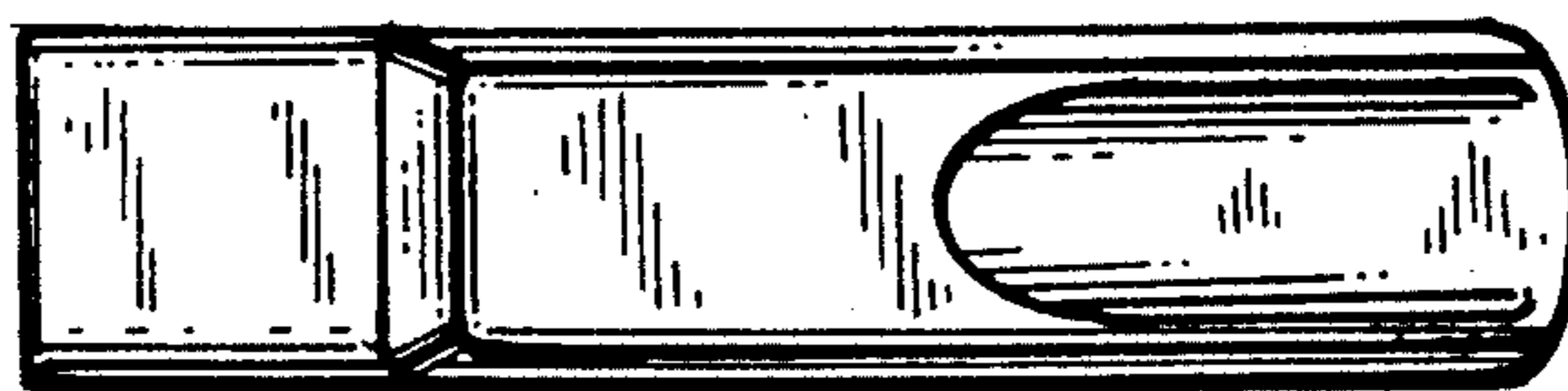

FIG. 6